

MERCHANT SHIPPING ACT  
(CHAPTER 179, SECTION 100)

MERCHANT SHIPPING (LOAD LINE) REGULATIONS

ARRANGEMENT OF REGULATIONS

Regulation

1. Citation
  2. Definitions
  3. General provisions
  4. Application
  5. Exceptions
  6. Exemptions
  7. Force majeure
  8. Equivalents
  9. Approvals for experimental purposes
  10. Repairs, alterations and modifications
  11. Zones and areas
  12. Submersion
  13. Surveys and marking
  14. Initial, renewal and annual surveys
  15. Maintenance of conditions after survey
  16. Issue of certificate
  17. Issue or endorsement of certificates by another Government
  18. Form of certificates
  19. Duration and validity of certificates
  20. Acceptance of certificates
  21. Control
  22. Privileges
  23. Casualties
  24. Availability of certificates
  25. Penalty
- 

[3rd February 2000]

**Citation**

1. These Regulations may be cited as the Merchant Shipping (Load Line) Regulations.

## Definitions

2. For the purposes of these Regulations, unless otherwise expressly provided —

“anniversary date” means the day and the month of each year which will correspond to the date of expiry of the relevant certificate;

“approved” means approved by the Director or any Recognised Organisation;

*[S 12/2005 wef 06/01/2005]*

“Contracting Government” means any government which has consented to be bound by the Convention and for which the Convention is in force;

*[S 12/2005 wef 06/01/2005]*

“Convention” or “present Convention” means the International Convention on Load Lines 1966, as modified by the Protocol of 1988 relating to it;

*[S 796/2015 wef 01/01/2016]*

“existing ship” means a ship which is not a new ship;

“fishing vessel” is a ship used for catching fish, whales, seals, walrus or other living resources of the sea;

“IMO” or “Organisation” means the International Maritime Organization;

*[S 796/2015 wef 01/01/2016]*

“international voyage” means a sea voyage from Singapore to a port or place outside Singapore, or conversely or a voyage between ports or places outside Singapore;

“length” means 96% of the total length on a waterline at 85% of the least moulded depth measured from the top of the keel, or the length from the fore-side of the stem to the axis of the rudder stock on that waterline, if that be greater. Where the stem contour is concave above the waterline at 85% of the least moulded depth, both the forward terminal of the total length and the fore-side of the stem respectively shall be taken at the vertical projection to that waterline of the

aftermost point of the stem contour (above that waterline). In ships designed with a rake of keel the waterline on which this length is measured shall be parallel to the designed waterline;

“new ship” means a ship the keel of which was laid, or which was at a similar stage of construction, on or after 21st December 1971;

*[Deleted by S 796/2015 wef 01/01/2016]*

“present Protocol” means the Protocol of 1988 relating to the International Convention on Load Lines, 1966;

*[S 865/2014 wef 01/01/2015]*

“Recognised Organisation” means any organisation authorised under the Act for the survey or inspection of Singapore ships and the issue of any certificate under Part V of the Act;

*[S 12/2005 wef 06/01/2005]*

“tons” means gross tonnage measured in accordance with the Merchant Shipping (Tonnage) Regulations (Rg 12).

### **General provisions**

3.—(1) No ship to which these Regulations apply shall proceed to sea on an international voyage after the date on which these Regulations come into force unless it has been surveyed, marked and provided with an International Load Line Certificate or, where appropriate, International Load Line Exemption Certificate, or Singapore Load Line Certificate or Singapore Load Line Exemption Certificate in accordance with the provisions of these Regulations.

(2) The Director or any Recognised Organisation may assign a greater freeboard than the minimum freeboard determined in accordance with Annex I to these Regulations.

*[S 12/2005 wef 06/01/2005]*

### **Application**

4.—(1) These Regulations shall apply to ships engaged on international voyages.

(2) The regulations contained in Annex I, unless otherwise expressly provided, shall be applicable to new ships.

(3) Existing ships which do not fully comply with the requirements of the regulations contained in Annex I or any part thereof shall meet at least such lesser related requirements as the Director applied to ships on international voyages prior to the coming into force of these Regulations; in no case shall such ships be required to increase their freeboards.

(4) In order to take advantage of any reduction in freeboard from that previously assigned, existing ships shall comply with all requirements of these Regulations.

(5) The regulations contained in Annex II shall be applicable to new and existing ships to which these Regulations apply.

### **Exceptions**

5.—(1) These Regulations shall not apply to —

- (a) ships of war;
- (b) wooden ships of primitive build not fitted with any mechanical means of propulsion;
- (c) ships solely employed in the fishing industry;
- (d) pleasure yachts not engaged in trade.

(2) Nothing in these Regulations shall apply to ships solely navigating —

- (a) the Great Lakes of North America and the River St. Lawrence as far east as a rhumb line drawn from Cap des Rosiers to West Point, Anticosti Island, and, on the north side of Anticosti Island, the meridian of longitude 63°W;
- (b) the Caspian Sea;
- (c) the Plate, Parana and Uruguay Rivers as far east as a rhumb line drawn between Punta Rasa (Cabo San Antonio), Argentina, and Punta del Este, Uruguay.

## Exemptions

6.—(1) Ships when engaged on international voyages between the near neighbouring ports of 2 or more States may be exempted by the Director from the provisions of these Regulations, so long as they shall remain engaged on such voyages, if the Director and the Governments of the States in which such ports are situated are satisfied that the sheltered nature or conditions of such voyages between such ports make it unreasonable or impracticable to apply the provisions of these Regulations to ships engaged on such voyages.

(2) The Director may exempt any ship which embodies features of a novel kind from any of the provisions of these Regulations the application of which might seriously impede research into the development of such features and their incorporation in ships engaged on international voyages.

(3) Any ship exempted under paragraph (2) shall, however, comply with safety requirements, which, in the opinion of the Director, are adequate for the service for which it is intended and are such as to ensure the overall safety of the ship and which are acceptable to the Governments of the States to be visited by the ship.

(4) A ship which is not normally engaged on international voyages but which, in exceptional circumstances, is required to undertake a single international voyage may be exempted by the Director from any of the requirements of these Regulations, provided that it complies with safety requirements which, in the opinion of the Director are adequate for the voyage which is to be undertaken by the ship.

## Force majeure

7. A ship which is not subject to the provisions of these Regulations at the time of its departure on any voyage shall not become subject to such provisions on account of any deviation from its intended voyage due to stress of weather or any other cause of *force majeure*.

## **Equivalents**

8. The Director may allow any fitting, material, appliance or apparatus to be fitted, or any other provision to be made in a ship, other than that required by these Regulations, if it is satisfied by trial thereof or otherwise that such fitting, material, appliance or apparatus, or provision, is at least as effective as that required by these Regulations.

## **Approvals for experimental purposes**

9. The Director may make specific approvals for experimental purposes in respect of a ship to which these Regulations apply.

## **Repairs, alterations and modifications**

10.—(1) A ship which undergoes repairs, alterations, modifications and outfitting related thereto shall continue to comply with at least the requirements previously applicable to the ship.

(2) An existing ship in a case referred to in paragraph (1) shall not, as a rule, comply to a lesser extent with the requirements for a new ship than it did before.

(3) Repairs, alterations and modifications of a major character and outfitting related thereto should meet the requirements for a new ship in so far as the Director deems reasonable and practicable.

## **Zones and areas**

11.—(1) A ship to which these Regulations apply shall comply with the requirements applicable to that ship in the zones and areas described in Annex II.

(2) A port standing on the boundary line between 2 zones or areas shall be regarded as within the zone or area from or into which the ship arrives or departs.

## **Submersion**

12.—(1) Except as provided in paragraphs (2) and (3), the appropriate load lines on the sides of the ship corresponding to the season of the year and the zone or area in which the ship may be shall

not be submerged at any time when the ship puts to sea, during the voyage or on arrival.

(2) When a ship is in fresh water of unit density the appropriate load line may be submerged by the amount of the fresh water allowance shown on the International Load Line Certificate or the Singapore Load Line Certificate.

(3) Where the density is other than unity, an allowance shall be made proportional to the difference between 1.025 and the actual density.

(4) When a ship departs from a port situated on a river or inland waters, deeper loading shall be permitted corresponding to the weight of fuel and all other materials required for consumption between the point of departure and the sea.

### **Surveys and marking**

**13.—**(1) The surveys and marking of ships shall be carried out by the Director or officers of any Recognised Organisation.

(2) The enforcement of these Regulations and the granting of exemptions therefrom shall be carried out only by the Director.

*[S 12/2005 wef 06/01/2005]*

### **Initial, renewal and annual surveys**

**14.—**(1) A ship shall be subjected to the following surveys:

- (a) an initial survey before the ship is put in service, which shall include a complete inspection of its structure and equipment in so far as the ship is covered by these Regulations; the survey shall be such as to ensure that the arrangements, materials and scantlings fully comply with the requirements of these Regulations;
- (b) a renewal survey at intervals specified by the Director but not exceeding 5 years, except where regulation 19(3), (8), (10), (12) and (14) is applicable, which shall be such as to ensure the structure, equipment, arrangements, materials and scantlings fully comply with these Regulations; and

- (c) an annual survey within 3 months before or after each anniversary date of the certificate to ensure that —
- (i) alterations have not been made to the hull or superstructures which would affect the calculations determining the position of the load line;
  - (ii) the fittings and appliances for the protection of openings, guard rails, freeing ports and means of access to crew's quarters are maintained in an effective condition;
  - (iii) the freeboard marks are correctly and permanently indicated; and
  - (iv) the information required by regulation 10 of Annex I is provided.

(2) The annual surveys referred to in paragraph (1)(c) shall be endorsed on the International Load Line Certificate, the International Load Line Exemption Certificate, the Singapore Load Line Certificate, or the Singapore Load Line Exemption Certificate issued to a ship exempted under regulation 6(2).

### **Maintenance of conditions after survey**

**15.** After any survey of ship under regulation 14 has been completed, no change shall be made in the structure, equipment, arrangements, material or scantlings covered by the survey, without the sanction of the Director.

### **Issue of certificate**

**16.—(1)** An International Load Line Certificate shall be issued by the Director or any Recognised Organisation to every ship of 24 metres in length and above which has been surveyed and marked in accordance with these Regulations.

*[S 12/2005 wef 06/01/2005]*

(2) A Singapore Load Line Certificate shall be issued by the Director or any Recognised Organisation to every new ship of less than 24 metres in length or every existing ship of less than 150 tons



which has been surveyed and marked in accordance with these Regulations.

*[S 12/2005 wef 06/01/2005]*

(3) An International Load Line Exemption Certificate or a Singapore Load Line Exemption Certificate, where appropriate, shall be issued by the Director or any Recognised Organisation to any ship to which an exemption has been granted under and in accordance with regulation 6(2) or (4).

*[S 12/2005 wef 06/01/2005]*

### **Issue or endorsement of certificates by another Government**

**17.**—(1) The Director may at the request of another Contracting Government of the Convention cause a ship to be surveyed and, if satisfied that the provisions of these Regulations are complied with, may —

- (a) issue or authorise the issue of the International Load Line Certificate to the ship; and
- (b) where appropriate, endorse or authorise the endorsement of the certificate on the ship in accordance with these Regulations.

(2) A certificate so issued must contain a statement to the effect that it has been issued at the request of the Government of the State whose flag the ship is or will be flying and it shall have the same force and receive the same recognition as a certificate issued under regulation 16.

(3) No International Load Line Certificate shall be issued to a ship which is flying the flag of a State the Government of which is not a Contracting Government of the Convention.

### **Form of certificates**

**18.** The certificates referred to in these Regulations shall be drawn up in the form corresponding to the specimens given in Annex III.

### **Duration and validity of certificates**

19.—(1) An International Load Line Certificate or a Singapore Load Line Certificate shall be issued for a period specified by the Director, which shall not exceed 5 years.

(2) Notwithstanding the requirements of paragraph (1), when the renewal survey is completed within 3 months before the expiry date of the existing certificate, the new certificate shall be valid from the date of completion of the renewal survey to a date not exceeding 5 years from the date of expiry of the existing certificate.

(3) When the renewal survey is completed after the expiry date of the existing certificate, the new certificate shall be valid from the date of completion of the renewal survey to a date not exceeding 5 years from the date of expiry of the existing certificate.

(4) When the renewal survey is completed more than 3 months before the expiry date of the existing certificate, the new certificate shall be valid from the date of completion of the renewal survey to a date not exceeding 5 years from the date of completion of the renewal survey.

(5) If a certificate is issued for a period of less than 5 years, the Director may extend the validity of a certificate beyond the expiry date to the maximum period specified in paragraph (1), provided that the annual surveys referred to in regulation 14 applicable when a certificate is issued for a period of 5 years are carried out as appropriate.

(6) If, after the renewal survey referred to in regulation 14(1)(b), a new certificate cannot be issued to the ship before the expiry date of the existing certificate, the Director or any Recognised Organisation may extend the validity of the existing certificate for a period which shall not exceed 5 months.

*[S 12/2005 wef 06/01/2005]*

(7) The extension under paragraph (6) shall be endorsed on the certificate and shall be granted only where there have been no alterations to the structure, equipment, arrangements, materials or scantlings which affect the ship's freeboard.

(8) If a ship at the time when a certificate expires is not in a port in which it is to be surveyed, the Director may extend the period of validity of the certificate.

(9) The extension under paragraph (8) shall be granted only for the purpose of allowing the ship to complete its voyage to the port in which it is to be surveyed, and then only in cases where it appears proper and reasonable to do so.

(10) No certificate shall be extended under paragraph (8) for a period longer than 3 months, and a ship to which an extension is granted shall not, on its arrival in the port in which it is to be surveyed, be entitled by virtue of such extension to leave that port without having a new certificate.

(11) When the renewal survey is completed, the new certificate issued under paragraph (10) shall be valid to a date not exceeding 5 years from the date of expiry of the existing certificate before the extension was granted.

(12) A certificate issued to a ship engaged on short voyages which has not been extended under the foregoing provisions of this regulation may be extended by the Director for a period of grace of up to one month from the date of expiry stated on it.

(13) When the renewal survey is completed for a ship the certificate of which has been extended under paragraph (12), the new certificate shall be valid to a date not exceeding 5 years from the date of expiry of the existing certificate before the extension was granted.

(14) In special circumstances, as determined by the Director, a new certificate need not be dated from the expiry of the existing certificate as required by paragraphs (2), (3), (11) and (13).

(15) In these special circumstances, the new certificate shall be valid to a date not exceeding 5 years from the date of completion of the renewal survey.

(16) If an annual survey is completed before the period specified in regulation 14 then —

- (a) the anniversary date shown on the certificate shall be amended by endorsement to a date which shall not be more

than 3 months later than the date on which the survey was completed;

- (b) the subsequent annual survey required by regulation 14 shall be completed at the intervals prescribed by that regulation using the new anniversary date;
- (c) the expiry date may remain unchanged provided one or more annual surveys are carried out so that the maximum intervals between the surveys prescribed by regulation 14 are not exceeded.

(17) An International Load Line Certificate or a Singapore Load Line Certificate shall cease to be valid if any of the following circumstances exist:

- (a) material alterations have taken place in the hull or superstructures of the ship such as would necessitate the assignment of an increased freeboard;
- (b) the fittings and appliances mentioned in regulation 14(1)(c) are not maintained in an effective condition;
- (c) the certificate is not endorsed to show that the ship has been surveyed as provided in regulation 14(1)(c);
- (d) the structural strength of the ship is lowered to such an extent that the ship is unsafe.

(18) The duration of an International Load Line Exemption Certificate or a Singapore Load Line Exemption Certificate issued by the Director or any Recognised Organisation to a ship exempted under regulation 6(2) shall not exceed 5 years.

*[S 12/2005 wef 06/01/2005]*

(19) A certificate referred to in paragraph (18) shall be subject to a renewal, endorsement, extension and cancellation procedure similar to that provided for an International Load Line Certificate or a Singapore Load Line Certificate under this regulation.

(20) The duration of an International Load Line Exemption Certificate or a Singapore Load Line Exemption Certificate issued

to a ship exempted under regulation 6(4) shall be limited to the single voyage for which it is issued.

(21) A certificate issued to a ship by the Director or any Recognised Organisation shall cease to be valid upon the transfer of such a ship to the flag of another State.

*[S 12/2005 wef 06/01/2005]*

(22) Notwithstanding any other provisions of the present Convention, any certificate which is issued under the Merchant Shipping (Load Line) Regulations immediately in force prior to these Regulations and which is valid on 2nd February 2000 shall remain valid until it expires.

### **Acceptance of certificates**

**20.** The certificates issued under the authority of a Contracting Government in accordance with the Convention shall be accepted by the Director and regarded for all purposes covered by the Convention as having the same force as certificates issued by the Director.

*[S 12/2005 wef 06/01/2005]*

### **Control**

**21.—**(1) Ships holding a certificate issued under regulation 16 or 17 are subject, when in the ports of other Contracting Governments, to control by officers duly authorised by such Governments.

(2) Contracting Governments shall ensure that such control is exercised as far as is reasonable and practicable with a view to verifying that there is on board a valid certificate under the Convention.

(3) If there is a valid International Load Line Certificate on board the ship, such control shall be limited to the purpose of determining that —

- (a) the ship is not loaded beyond the limits allowed by the certificate;
- (b) the position of the load line of the ship corresponds with the certificate; and

(c) the ship has not been so materially altered in respect to the matters set out in regulation 19(17)(a) and (b) that the ship is manifestly unfit to proceed to sea without danger to human life.

(4) If there is a valid International Load Line Exemption Certificate on board, such control shall be limited to the purpose of determining that any conditions stipulated in that certificate are complied with.

(5) If such control is exercised under paragraph (3)(c), it shall only be exercised in so far as may be necessary to ensure that the ship shall not sail until it can proceed to sea without danger to the passengers or the crew.

(6) In the event of the control provided for in this regulation giving rise to intervention of any kind, the officer carrying out the control shall immediately inform in writing the Consul or the diplomatic representative of the State whose flag the ship is flying of this decision and of all the circumstances in which intervention was deemed to be necessary.

### **Privileges**

**22.** A ship will not be entitled to any privileges under these Regulations unless it holds a valid certificate under these Regulations.

### **Casualties**

**23.** The Director may undertake to conduct an investigation of any casualty occurring to ships for which it is responsible and which are subject to the provisions of these Regulations when he judges that such an investigation may assist in determining what changes in these Regulations might be desirable.

### **Availability of certificates**

**24.** All certificates issued under these Regulations or certified copies thereof shall be readily available on board for examination at all times.

**Penalty**

**25.**—(1) The owner and the master of a ship to which these Regulations apply shall —

- (a) comply with these Regulations in respect of any matter that is governed thereby; and
- (b) ensure that the ship and its equipment comply with these Regulations.

(2) Any owner or master of a ship who contravenes paragraph (1) shall be guilty of an offence and shall be liable on conviction to a fine not exceeding \$10,000 and the ship may be detained.

ANNEX I

REGULATIONS FOR DETERMINING LOAD LINES

CHAPTER I

GENERAL

The regulations assume that the nature and stowage of the cargo, ballast, etc., are such as to secure sufficient stability of the ship and the avoidance of excessive structural stress.

The regulations also assume that where there are international requirements relating to stability or subdivision, these requirements have been complied with.

*Regulation 1*

*Strength and intact stability of ships*

(1) The general structural strength of the ship shall be adequate for the draught corresponding to the freeboard assigned and shall be to the satisfaction of the Director or any Recognised Organisation.

(2) A ship which is designed, constructed and maintained in compliance with the appropriate requirements of a Recognised Organisation, which is authorised by the Director in accordance with the provisions of regulation 2-1, may be considered to provide an acceptable level of strength. The above provisions shall apply to all structures, equipment and fittings covered by this Annex for which standards for strength and construction are not expressly provided.

*[S 865/2014 wef 01/01/2015]*

(3) *Compliance*

- (a) Ships constructed before 1st July 2010 shall comply with an intact stability standard acceptable to the Director or any Recognised Organisation.
- (b) Ships constructed on or after 1st July 2010 shall, at the minimum, comply with the requirements of Part A of the 2008 IS Code.

*[S 330/2010 wef 01/07/2010]*

*Regulation 2*

*Application*

(1) Ships with mechanical means of propulsion or lighters, barges or other ships without independent means of propulsion, shall be assigned freeboards in accordance with the provisions of regulations 1 to 40, inclusive.

(2) Ships carrying timber deck cargoes may be assigned, in addition to the freeboards prescribed in paragraph (1), timber freeboards in accordance with the provisions of regulations 41 to 45, inclusive.

(3) Ships designed to carry sail, whether as the sole means of propulsion or as a supplementary means, and tugs, shall be assigned freeboards in accordance with the provisions of regulations 1 to 40, inclusive. Additional freeboard may be required as determined by the Director or any Recognised Organisation.

(4) Ships of wood or of composite construction, or of other materials the use of which the Director or any Recognised Organisation has approved, or ships whose constructional features are such as to render the application of the provisions of this Annex unreasonable or impracticable, shall be assigned freeboards as determined by the Director or any Recognised Organisation.

(5) Regulations 10 to 26, inclusive, shall apply to every ship to which a minimum freeboard is assigned. Relaxations from these requirements may be granted to a ship to which a greater than minimum freeboard is assigned on condition that the Director is satisfied with the safety conditions provided.

(6) Where the assigned summer freeboard is increased such that the resulting draught is not more than that corresponding to a minimum summer freeboard for the same ship, but with an assumed freeboard deck located a distance below the actual freeboard deck at least equal to the standard superstructure height, the conditions of assignment in accordance with regulations 12, 14-1 through 20, 23, 24 and 25, as applicable, to the actual freeboard deck may be as required for a superstructure deck.

(7) Unless expressly provided otherwise, the regulations of this Annex shall apply to ships the keels of which are laid or which are at a similar stage of construction on or after 6th January 2005.



(8) For ships the keels of which are laid or which are at a similar stage of construction before 6th January 2005, the Director or any Recognised Organisation shall ensure that the requirements which were applicable to them prior to the coming into force of these regulations are complied with.

(9) High-speed craft which comply with the requirements of the International Code of Safety for High-Speed Craft, 2000 (2000 HSC Code), adopted by the Maritime Safety Committee of the Organisation by resolution MSC.97 (73) and which have been surveyed and certified as provided in the Code shall be deemed to have complied with the requirements of this Annex. The certificates and permits issued under the 2000 HSC Code shall have the same force and the same recognition as the certificates issued under this Annex.

(10) In calculating freeboard for ships of less than 24 metres in length, the length of ship shall be taken as 24 metres.

(11) Relaxations or dispensations from the requirements of this Annex may be granted to new ships of less than 24 metres in length and existing ships of less than 150 tons if the Director is satisfied that the ship's constructional features and nature of voyage render the compliance with this Annex impracticable or unreasonable.

*Regulation 2-1*

*Authorisation of Recognised Organisations*

(1) The Director shall authorise Recognised Organisations in accordance with the provisions of the Convention and with parts 1 and 2 of the Code for Recognized Organizations (RO Code) as adopted by the Organisation by resolution MSC.349(92), taking into account the guidance provided in part 3 of the RO Code.

(2) A Recognised Organisation shall comply with such provisions in part 2 of the RO Code as may be applicable to it.

(3) The Director and any authorised organisation shall be bound by any amendments to part 1 or 2 of the RO Code, and the Director shall be guided by any amendments to part 3 of the RO Code, provided that —

- (a) the amendments to part 1 or 2 of the RO Code are adopted, brought into force and take effect in accordance with the provisions of article VI of the present Protocol;
- (b) the amendments to part 3 of the RO Code are adopted by the Maritime Safety Committee in accordance with its Rules of Procedure; and

- (c) the amendments adopted by the Maritime Safety Committee and the Marine Environment Protection Committee are identical and come into force or take effect at the same time, as appropriate.

[S 865/2014 wef 01/01/2015]

Regulation 3

Definitions of terms used in the Annexes

(1) Length.

- (a) The length (L) shall be taken as 96% of the total length on a waterline at 85% of the least moulded depth measured from the top of the keel, or as the length from the fore side of the stem to the axis of the rudder stock on that waterline, if that be greater.
- (b) For ships without a rudder stock, the length (L) is to be taken as 96% of the waterline at 85% of the least moulded depth.
- (c) Where the stem contour is concave above the waterline at 85% of the least moulded depth, both the forward terminal of the total length and the fore-side of the stem respectively shall be taken at the vertical projection to that waterline of the aftermost point of the stem contour (above that waterline) (see figure 3.1).

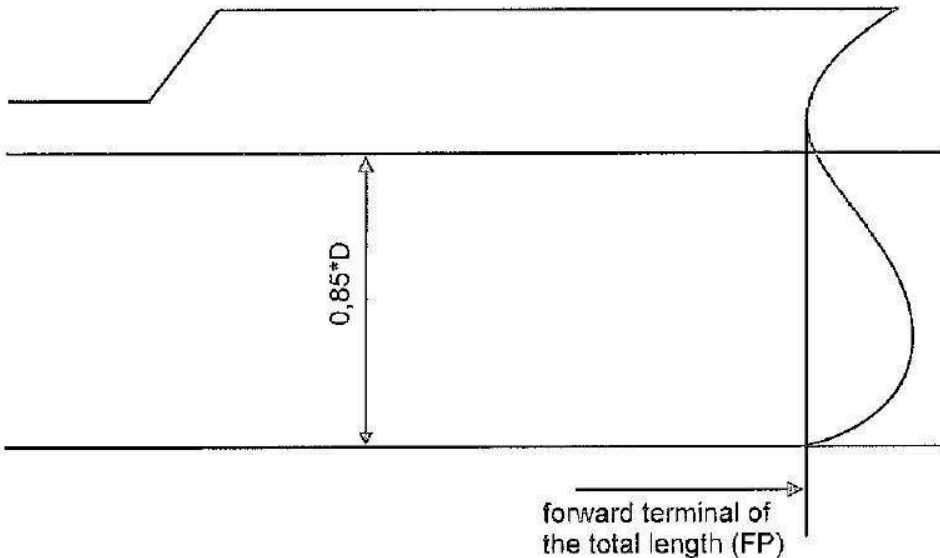

Figure 3.1

- (d) In ships designed with a rake of keel the waterline on which this length is measured shall be parallel to the designed waterline at 85% of the least moulded depth  $D_{min}$ , found by drawing a line parallel to the keel

line of the vessel (including skag) tangent to the moulded sheer line of the freeboard deck. The least moulded depth is the vertical distance measured from the top of the keel to the top of the freeboard deck beam at side at the point of tangency (see figure 3.2).

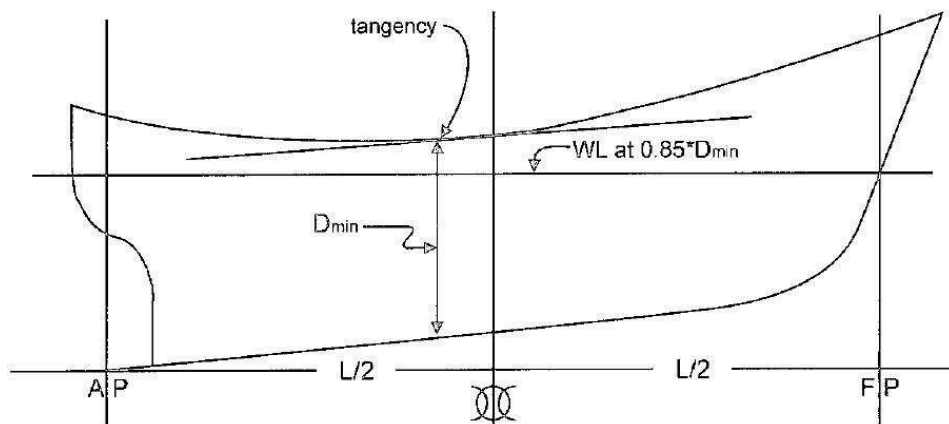

Figure 3.2

(2) *Perpendiculars*. The forward and after perpendiculars shall be taken at the forward and after ends of the length (L). The forward perpendicular shall coincide with the foreside of the stem on the waterline on which the length is measured.

(3) *Amidships*. Amidships is at the middle of the length (L).

(4) *Breadth*. Unless expressly provided otherwise, the breadth (B) is the maximum breadth of the ship, measured amidships to the moulded line of the frame in a ship with a metal shell and to the outer surface of the hull in a ship with a shell of any other material.

(5) *Moulded depth*

- (a) The moulded depth is the vertical distance measured from the top of the keel to the top of the freeboard deck beam at side. In wood and composite ships the distance is measured from the lower edge of the keel rabbet. Where the form at the lower part of the midship section is of a hollow character, or where thick garboards are fitted, the distance is measured from the point where the line of the flat of the bottom continued inwards cuts the side of the keel.
- (b) In ships having rounded gunwales, the moulded depth shall be measured to the point of intersection of the moulded lines of deck and sides, the lines extending as though the gunwale were of angular design.
- (c) Where the freeboard deck is stepped and the raised part of the deck extends over the point at which the moulded depth is to be determined,

the moulded depth shall be measured to a line of reference extending from the lower part of the deck along a line parallel with the raised part.

(6) *Depth for freeboard (D)*

- (a) The depth for freeboard (D) is the moulded depth amidships, plus the freeboard deck thickness at side.
- (b) The depth for freeboard (D) in a ship having a rounded gunwale with a radius greater than 4% of the breadth (B) or having topsides of unusual form is the depth for freeboard of a ship having a midship section with vertical topsides and with the same round of beam and area of topside section equal to that provided by the actual midship section.

(7) *Block coefficient*

- (a) The block coefficient ( $C_b$ ) is given by:

$$C_b = \frac{\nabla}{L \nabla B \nabla d_1};$$

where

- $\nabla$  is the volume of the moulded displacement of the ship, excluding appendages, in a ship with a metal shell, and is the volume of displacement to the outer surface of the hull in a ship with a shell of any other material, both taken at a moulded draught of  $d_1$ ; and where

$d_1$  is 85% of the least moulded depth.

- (b) When calculating the block coefficient of a multi-hull craft, the full breadth (B) as defined in paragraph (4) is to be used and not the breadth of a single hull.

(8) *Freeboard.* The freeboard assigned is the distance measured vertically downwards amidships from the upper edge of the deck line to the upper edge of the related load line.

(9) *Freeboard deck*

- (a) The freeboard deck is normally the uppermost complete deck exposed to weather and sea, which has permanent means of closing all openings in the weather part thereof, and below which all openings in the sides of the ship are fitted with permanent means of watertight closing.
- (b) *Lower deck as a freeboard deck.* At the option of the owner and subject to the approval of the Director or any Recognised Organisation, a lower deck may be designated as the freeboard deck provided it is a complete and permanent deck continuous in a fore and aft direction at

least between the machinery space and peak bulkheads and continuous athwartships.

- (i) When this lower deck is stepped the lowest line of the deck and the continuation of that line parallel to the upper part of the deck is taken as the freeboard deck.
  - (ii) When a lower deck is designated as the freeboard deck, that part of the hull which extends above the freeboard deck is treated as a superstructure so far as concerns the application of the conditions of assignment and the calculation of freeboard. It is from this deck that the freeboard is calculated.
  - (iii) When a lower deck is designated as the freeboard deck, such deck as a minimum shall consist of suitably framed stringers at the ship sides and transversely at each watertight bulkhead which extends to the upper deck, within cargo spaces. The width of these stringers shall not be less than can be conveniently fitted having regard to the structure and the operation of the ship. Any arrangement of stringers shall be such that structural requirement can also be met.
- (c) Discontinuous freeboard deck, stepped freeboard deck.
- (i) Where a recess in the freeboard deck extends to the sides of the ship and is in excess of one metre in length, the lowest line of the exposed deck and the continuation of that line parallel to the upper part of the deck is taken as the freeboard deck (see figure 3.3).
  - (ii) Where a recess in the freeboard deck does not extend to the sides of the ship, the upper part of the deck is taken as the freeboard deck.
  - (iii) Recesses not extending from side to side in a deck below the exposed deck, designated as the freeboard deck, may be disregarded, provided all openings in the weather deck are fitted with weathertight closing appliances.
  - (iv) Due regard shall be given to the drainage of exposed recesses and to free surface effects on stability.
  - (v) Provisions of sub-paragraphs (i) through (iv) are not intended to apply to dredgers, hopper barges or other similar types of ships with large open holds, where each case requires individual consideration.

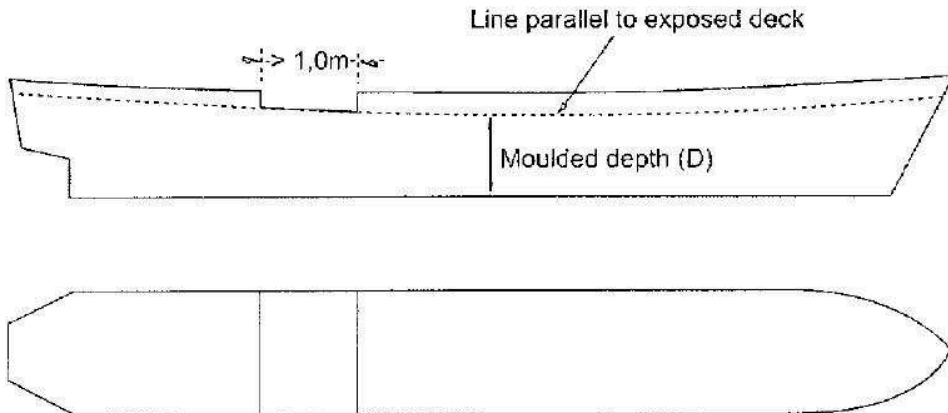

Figure 3.3

(10) *Superstructure*

- (a) A superstructure is a decked structure on the freeboard deck, extending from side to side of the ship or with the side plating not being inboard of the shell plating more than 4% of the breadth (B).
- (b) An enclosed superstructure is a superstructure with:
- (i) enclosing bulkheads of efficient construction;
  - (ii) access openings, if any, in these bulkheads fitted with doors complying with the requirements of regulation 12;
  - (iii) all other openings in sides or ends of the superstructure fitted with efficient weathertight means of closing.
- A bridge or poop shall not be regarded as enclosed unless access is provided for the crew starting from any point on the uppermost complete exposed deck or higher to reach machinery and other working spaces inside these superstructures by alternative means which are available at all times when bulkhead openings are closed.
- (c) The height of a superstructure is the least vertical height measured at side from the top of the superstructure deck beams to the top of the freeboard deck beams.
- (d) The length of a superstructure (S) is the mean length of the part of the superstructure which lies within the length (L).
- (e) *Bridge*. A bridge is a superstructure which does not extend to either the forward or after perpendicular.
- (f) *Poop*. A poop is a superstructure which extends from the after perpendicular forward to a point which is aft of the forward

perpendicular. The poop may originate from a point aft of the aft perpendicular.

- (g) *Forecastle*. A forecastle is a superstructure which extends from the forward perpendicular aft to a point which is forward of the after perpendicular. The forecastle may originate from a point forward of the forward perpendicular.
- (h) *Full superstructure*. A full superstructure is a superstructure which, as a minimum, extends from the forward to the after perpendicular.
- (i) *Raised quarterdeck*. A raised quarterdeck is a superstructure which extends forward from the after perpendicular, generally has a height less than a normal superstructure, and has an intact front bulkhead (sidescuttles of the non-opening type fitted with efficient deadlights and bolted man hole covers) (see figure 3.4). Where the forward bulkhead is not intact due to doors and access openings, the superstructure is then to be considered as a poop.

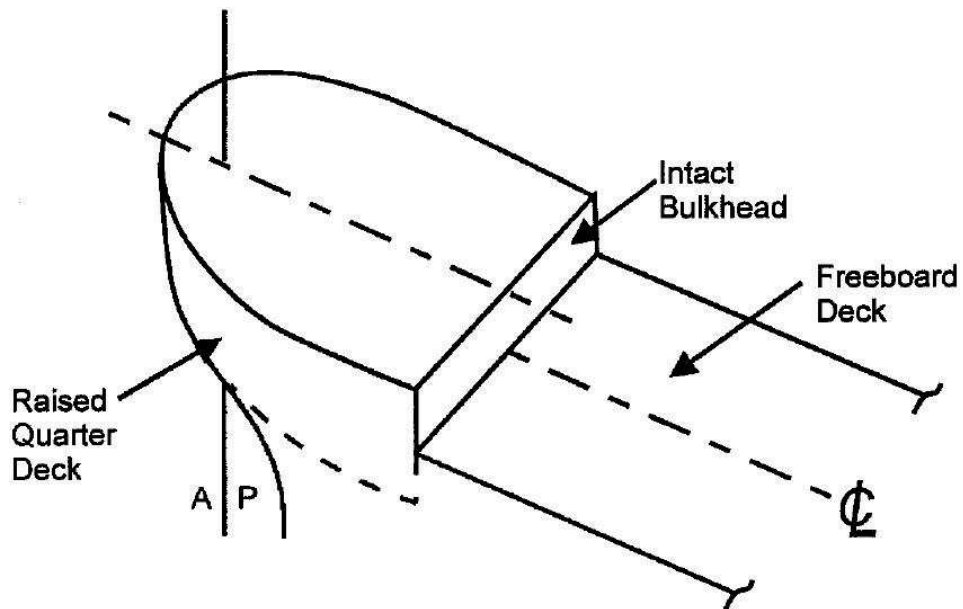

Figure 3.4

(11) *Superstructure deck*. A superstructure deck is a deck forming the upper boundary of a superstructure.

(12) *Flush deck ship*. A flush deck ship is one which has no superstructure on the freeboard deck.

(13) *Weathertight*. Weathertight means that in any sea conditions water will not penetrate into the ship.

(14) *Watertight.* Watertight means capable of preventing the passage of water through the structure in either direction with a proper margin of resistance under the pressure due to the maximum head of water which it might have to sustain.

(15) *Well.* A well is any area on the deck exposed to the weather, where water may be entrapped. Wells are considered to be deck areas bounded on two or more sides by deck structures.

(16) *2008 IS Code.* The 2008 IS Code is the International Code on Intact Stability, 2008, consisting of an introduction, Part A (the provisions of which shall be treated as mandatory) and Part B (the provisions of which shall be treated as recommendatory), as adopted by resolution MSC.267(85), and any amendment thereto which has come into force and has been accepted by the Government.

[S 330/2010 wef 01/07/2010]

Regulation 4

Deck line

The deck line is a horizontal line 300 mm in length and 25 mm in breadth. It shall be marked amidships on each side of the ship, and its upper edge shall normally pass through the point where the continuation outwards of the upper surface of the freeboard deck intersects the outer surface of the shell (as illustrated in figure 4.1), provided that the deck line may be placed with reference to another fixed point on the ship on condition that the freeboard is correspondingly corrected. The location of the reference point and the identification of the freeboard deck shall in all cases be indicated on the International Load Line Certificate or Singapore Load Line Certificate.

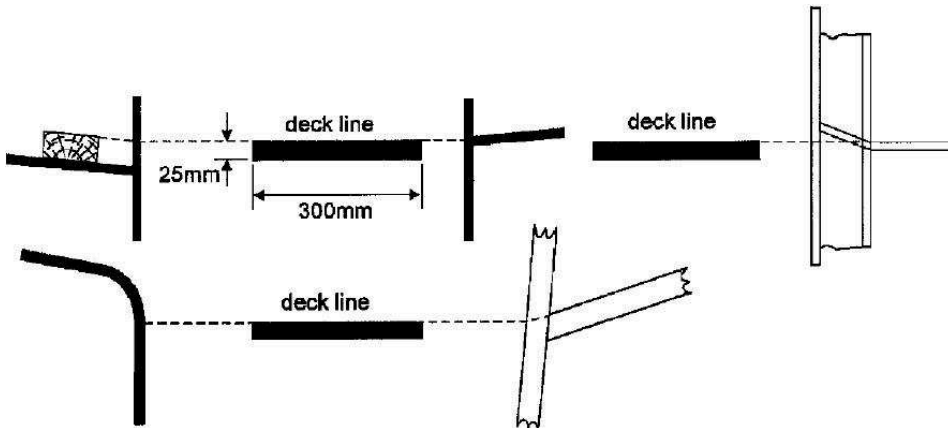



Figure 4.1 Deck Line

Regulation 5

Load line mark

The load line mark shall consist of a ring 300 mm in outside diameter and 25 mm wide which is intersected by a horizontal line 450 mm in length and 25 mm in breadth, the upper edge of which passes through the centre of the ring. The centre of the ring shall be placed amidships and at a distance equal to the assigned summer freeboard measured vertically below the upper edge of the deck line (as illustrated in figure 6.1).

Regulation 6

Lines to be used with the load line mark

(1) The lines which indicate the load line assigned in accordance with these regulations shall be horizontal lines 230 mm in length and 25 mm in breadth which extend forward of, unless expressly provided otherwise, and at right angles to, a vertical line 25 mm in breadth marked at a distance 540 mm forward of the centre of the ring (as illustrated in figure 6.1).

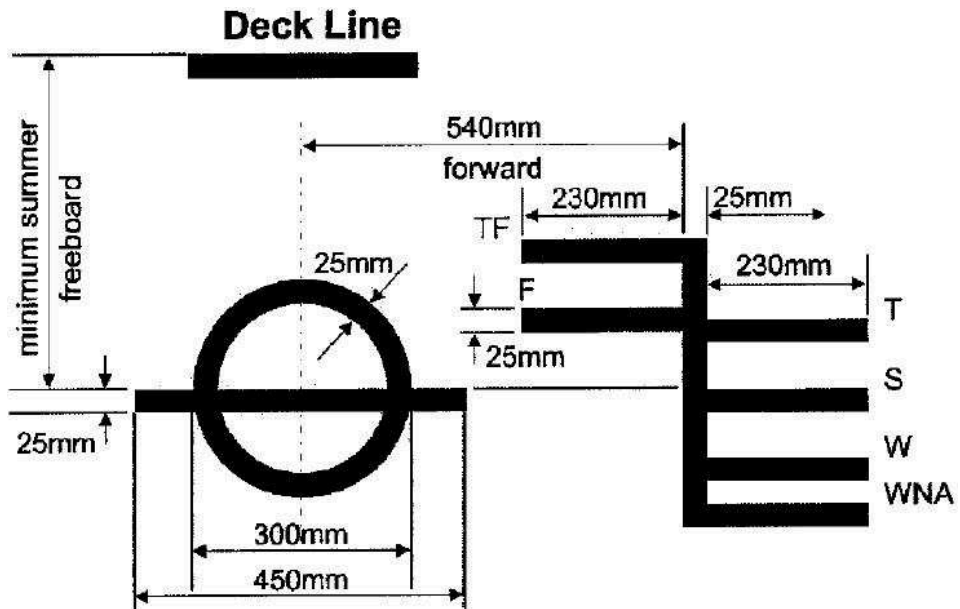

Figure 6.1 Load line mark and lines to be used with this mark

- (2) The following load lines shall be used:
  - (a) The Summer Load Line indicated by the upper edge of the line which passes through the centre of the ring and also by a line marked S.
  - (b) The Winter Load Line indicated by the upper edge of a line marked W.
  - (c) The Winter North Atlantic Load Line indicated by the upper edge of a line marked WNA.
  - (d) The Tropical Load Line indicated by the upper edge of a line marked T.
  - (e) The Fresh Water Load Line in summer indicated by the upper edge of a line marked F. The Fresh Water Load Line in summer is marked abaft the vertical line. The difference between the Fresh Water Load Line in summer and the Summer Load Line is the allowance to be made for loading in fresh water at the other load lines.
  - (f) The Tropical Fresh Water Load Line indicated by the upper edge of a line marked TF and marked abaft the vertical line.

(3) If timber freeboards are assigned in accordance with these regulations, the timber load lines shall be marked in addition to ordinary load lines. These lines shall be horizontal lines 230 mm in length and 25 mm in breadth which extend abaft unless expressly provided otherwise, and are at right angles to, a vertical line 25 mm in breadth marked at a distance 540 mm abaft the centre of the ring (as illustrated in figure 6.2).

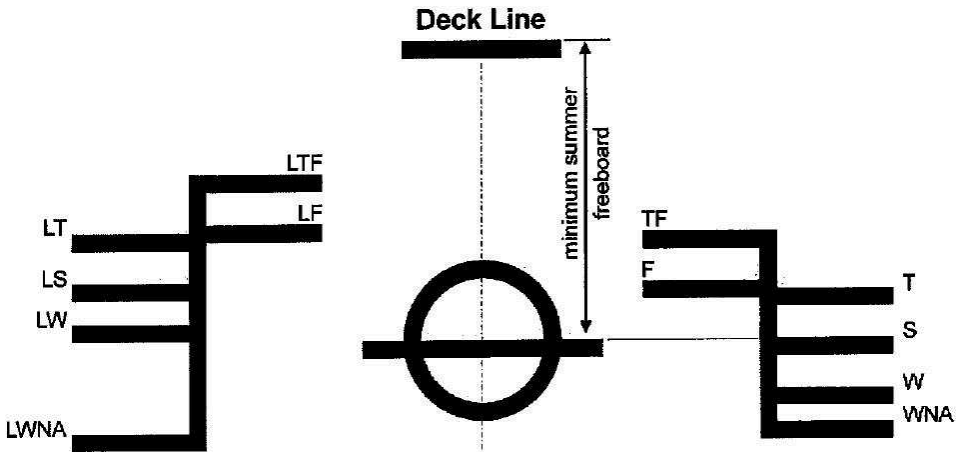

Figure 6.2 Timber load line mark and lines to be used with this mark

- (4) The following timber load lines shall be used:
  - (a) The Summer Timber Load Line indicated by the upper edge of a line marked LS.

- (b) The Winter Timber Load Line indicated by the upper edge of a line marked LW.
  - (c) The Winter North Atlantic Timber Load Line indicated by the upper edge of a line marked LWNA.
  - (d) The Tropical Timber Load Line indicated by the upper edge of a line marked LT.
  - (e) The Fresh Water Timber Load Line in summer indicated by the upper edge of a line marked LF and marked forward of the vertical line. The difference between the Fresh Water Timber Load Line in summer and the Summer Timber Load Line is the allowance to be made for loading in fresh water at the other timber load lines.
  - (f) The Tropical Fresh Water Timber Load Line indicated by the upper edge of a line marked LTF and marked forward of the vertical line.
- (5) Where the characteristics of a ship or the nature of the ships service or navigational limits make any of the seasonal lines inapplicable, these lines may be omitted.
- (6) Where a ship is assigned a greater than minimum freeboard so that the load line is marked at a position corresponding to, or lower than, the lowest seasonal load line assigned at minimum freeboard in accordance with the Convention, only the Fresh Water Load Line need be marked.
- (7) Where a Winter North Atlantic Load Line is identical with the Winter Load Line corresponding to the same vertical line, this load line shall be marked W.
- (8) Alternative/additional load lines required by other international conventions in force may be marked at right angles to and abaft the vertical line specified in paragraph (1).

*Regulation 7*

*Mark of assigning Authority*

The mark of the Director or any Recognised Organisation by whom the load lines are assigned may be indicated alongside the load line ring above the horizontal line which passes through the centre of the ring, or above and below it. This mark shall consist of not more than four initials to identify the Director or any Recognised Organisation's name, each measuring approximately 115 mm in height and 75 mm in width.

*Regulation 8**Details of marking*

The ring, lines and letters shall be painted in white or yellow on a dark ground or in black on a light ground. They shall also be permanently marked on the sides of the ships to the satisfaction of the Director or any Recognised Organisation. The marks shall be plainly visible and, if necessary, special arrangements shall be made for this purpose.

*Regulation 9**Verification of Marks*

The International Load Line Certificate or Singapore Load Line Certificate shall not be delivered to the ship until the Director or officer of any Recognised Organisation has certified that the marks are correctly and permanently indicated on the ship's sides.

[S 865/2014 wef 01/01/2015]

## CHAPTER II

## CONDITIONS OF ASSIGNMENT OF FREEBOARD

*Regulation 10**Information to be supplied to the master*

(1) The master of every new ship shall be supplied with information to arrange for the loading and ballasting of his ship in such a way as to avoid the creation of any unacceptable stresses in the ship's structure, provided that this requirement need not apply to any particular length, design or class of ship where the Director or any Recognised Organisation considers it to be unnecessary.

(2) Information shall be provided to the master in a form that is approved by the Director or any Recognised Organisation. Stability information, and loading information also related to ship strength when required under paragraph (1), shall be carried on board at all times together with evidence that the information has been approved by the Director or any Recognised Organisation.

(3) A ship which is not required under the International Convention for Safety of Life at Sea in force to undergo an inclining test upon its completion shall:

- (a) be so inclined and the actual displacement and position of the centre of gravity shall be determined for the lightship condition;
- (b) if the Director or any Recognised Organisation so approves, have its inclining test on completion dispensed with, provided basic stability data are available from the inclining test of a sister ship and it is shown

to the satisfaction of the Director or any Recognised Organisation that reliable stability information for the ship can be obtained from such basic data;

- (c) if the Director or any Recognised Organisation decides that the performance of an inclining experiment is not practicable or safe or yields inaccurate results due to the specific proportions, arrangements, strength or hull form of a ship, have the ship's lightship characteristics determined by a detailed weight estimate confirmed by a lightweight survey;
- (d) have such information<sup>1</sup> supplied for the use of its master as is necessary to enable the master, by rapid and simple processes, to obtain accurate guidance as to the stability of the ship under all conditions likely to be encountered in normal service; and
- (e) carry on board at all times its approved stability information together with evidence that the information has been approved by the Director or any Recognised Organisation.

(4) Where any alterations are made to a ship so as to materially affect the loading or stability information supplied to the master, amended information shall be provided. If necessary the ship shall be re-inclined.

*Regulation 11*

*Superstructure end bulkheads*

Bulkheads at exposed ends of enclosed superstructures shall be of acceptable level of strength.

*Regulation 12*

*Doors*

(1) All access openings in bulkheads at ends of enclosed superstructures shall be fitted with doors of steel or other equivalent material, permanently and strongly attached to the bulkhead, and framed, stiffened and fitted so that the whole structure is of equivalent strength to the un-pierced bulkhead and weathertight when closed. The means for securing these doors weathertight shall consist of gaskets and clamping devices or other equivalent means and shall be permanently attached to the bulkhead or to the doors themselves, and the doors shall be so arranged that they can be operated from both sides of the bulkhead.

---

<sup>1</sup>Refer to the *Code on Intact Stability for All Types of ships covered by IMO instruments*, adopted by the Organisation by resolution A.749 (18), as amended.

(2) Unless otherwise permitted by the Director or any Recognised Organisation, doors shall open outwards to provide additional security against the impact of the sea.

(3) Except as otherwise provided in these regulations, the height of the sills of access openings in bulkheads at ends of enclosed superstructures shall be at least 380 mm above the deck.

(4) Portable sills shall be avoided. However, in order to facilitate the loading/unloading of heavy spare parts or similar, portable sills may be fitted on the following conditions:

- (a) they shall be installed before the ship leaves port; and
- (b) they shall be gasketed and fastened by closely spaced through bolts.

### *Regulation 13*

#### *Position of hatchways, doorways and ventilators*

For the purpose of these Regulations, two positions of hatchways, doorways and ventilators are defined as follows:

Position 1 — Upon exposed freeboard and raised quarter decks, and upon exposed superstructure decks situated forward of a point located a quarter of the ship's length from the forward perpendicular.

Position 2 — Upon exposed superstructure decks situated abaft a quarter of the ship's length from the forward perpendicular and located at least one standard height of superstructure above the freeboard deck.

Upon exposed superstructure decks situated forward of a point located a quarter of the ship's length from the forward perpendicular and located at least two standard heights of superstructure above the freeboard deck.

### *Regulation 14*

#### *Cargo and other hatchways*

(1) The construction and means for securing the weathertightness of cargo and other hatchways in position 1 and 2 shall be at least equivalent to the requirements of regulation 16, unless the application of regulation 15 to such hatchways is granted by the Director or any Recognised Organisation.

(2) Coamings and hatchway covers to exposed hatchways on decks above the superstructure deck shall comply with the requirements of the Director or any Recognised Organisation.

*Regulation 14-1*

*Hatchway coamings*

(1) The coamings of hatchways shall be of substantial construction in accordance with their position, and their height above the deck shall be at least as follows:

(a) 600 mm if in position 1; and

(b) 450 mm if in position 2.

(2) In the case of hatchways which comply with regulation 16(2) through (5), the height of these coamings may be reduced, or the coamings omitted entirely, on condition that the Director is satisfied that the safety of the ship is not thereby impaired in any sea conditions.

*Regulation 15*

*Hatchways closed by portable covers and secured weathertight  
by tarpaulins and battening devices*

*Hatchway covers*

(1) The width of each bearing surface for hatchway covers shall be at least 65 mm.

(2) Where covers are made of wood, the finished thickness shall be at least 60 mm in association with a span of not more than 1.5 m.

(3) Where covers are made of mild steel the strength shall be calculated in accordance with the requirement of regulation 16(2) to (4) and the product of the maximum stress thus calculated and the factor 1.25 shall not exceed the minimum upper yield point strength of the material. They shall be so designed as to limit the deflection to not more than 0.0056 times the span under these loads.

*Portable beams*

(4) Where portable beams for supporting hatchway covers are made of mild steel, the strength shall be calculated with assumed loads not less than 3.5 t/m<sup>2</sup> on hatchways in position 1 and not less than 2.6 t/m<sup>2</sup> on hatchways in position 2 and the product of the maximum stress thus calculated and the factor 1.47 shall not exceed the minimum upper yield point strength of the material. They shall be so designed as to limit the deflection to not more than 0.0044 times the span under these loads.

(5) The assumed loads on hatchways in position 1 may be reduced to 2.0 t/m<sup>2</sup> for ships 24 m in length and shall be not less than 3.5 t/m<sup>2</sup> for ships 100 m in length. The corresponding loads on hatchways in position 2 may be reduced to 1.5 t/m<sup>2</sup> and 2.6 t/m<sup>2</sup>, respectively. In all cases, values at intermediate lengths shall be obtained by linear interpolation.

*Pontoon covers*

(6) Where pontoon covers used in place of portable beams and covers are made of mild steel, the strength shall be calculated in accordance with the requirement of regulation 16(2) to (4) and the product of the maximum stress thus calculated and the factor 1.47 shall not exceed the minimum upper yield point strength of the material. They shall be so designed as to limit the deflection to not more than 0.0044 times the span. Mild steel plating forming the tops of covers shall be not less in thickness than 1% of the spacing of stiffeners or 6 mm if that be greater.

(7) The strength and stiffness of covers made of materials other than mild steel shall be equivalent to those of mild steel to the satisfaction of the Director or any Recognised Organisation.

*Carriers or sockets*

(8) Carriers or sockets for portable beams shall be of substantial construction, and shall provide means for the efficient fitting and securing of the beams. Where rolling types of beams are used, the arrangements shall ensure that the beams remain properly in position when the hatchway is closed.

*Cleats*

(9) Cleats shall be set to fit the taper of the wedges. They shall be at least 65 mm wide and spaced not more than 600 mm centre to centre; the cleats along each side or end shall be not more than 150 mm from the hatch corners.

*Battens and wedges*

(10) Battens and wedges shall be efficient and in good condition. Wedges shall be of tough wood or other equivalent material. They shall have a taper of not more than 1 in 6 and shall be not less than 13 mm thick at the toes.

*Tarpaulins*

(11) At least two layers of tarpaulin in good condition shall be provided for each hatchway in position 1 or 2. The tarpaulins shall be waterproof and of ample strength. They shall be of a material of at least an approved standard weight and quality.

*Securing of hatchway covers*

(12) For all hatchways in position 1 or 2 steel bars or other equivalent means shall be provided in order efficiently and independently to secure each section of hatchway covers after the tarpaulins are battened down. Hatchway covers of more than 1.5 m in length shall be secured by at least two such securing appliances.



*Regulation 16*

*Hatchways closed by weathertight covers of steel or other equivalent materials*

(1) All hatchways in position 1 and 2 shall be fitted with hatch covers of steel or other equivalent material. Except as provided in regulation 14(2), such covers shall be weathertight and fitted with gaskets and clamping devices. The means for securing and maintaining weathertightness shall be to the satisfaction of the Director or any Recognised Organisation. The arrangements shall ensure that the tightness can be maintained in any sea conditions, and for this purpose tests for tightness shall be required at the initial survey, and may be required at renewal and annual surveys or at more frequent intervals.

*Hatch cover minimum design loads*

(2) For ships of 100 m in length and above:

- (a) Position 1 hatch covers located in the forward quarter of the ship's length shall be designed for wave loads at the forward perpendicular, calculated from the following equation:

$$\text{Load} = 5 + (L_H - 100)a \text{ in t/m}^2$$

where:

$L_H$  is L for ships of not more than 340 m but not less than 100 m in length and equal to 340 m for ships of more than 340 m in length;

L is the length of the ship (metres), as defined in regulation 3;

a is given in table 16.1,

and reduced linearly to 3.5 t/m<sup>2</sup> at the end of the forward quarter's length, as shown in table 16.2. The design load used for each hatch cover panel shall be that determined at its midpoint location.

- (b) All other position 1 hatch covers shall be designed to 3.5 t/m<sup>2</sup>.  
 (c) Position 2 hatch covers shall be designed to 2.6 t/m<sup>2</sup>.  
 (d) Where a position 1 hatchway is located at least one superstructure standard height higher than the freeboard deck, it may be designed to 3.5 t/m<sup>2</sup>.

	a
Type B Freeboard ships	0.0074
Ships assigned reduced freeboard by regulations 27(9) or (10)	0.0363

*Table 16.1*

(3) For ships 24 m in length:

- (a) Position 1 hatch covers located in the forward quarter of the ship's length shall be designed for wave loads of 2.43 t/m<sup>2</sup> at the forward perpendicular and reduced linearly to 2.0 t/m<sup>2</sup> at the end of the forward quarter's length as shown in table 16.2. The design load used for each hatch cover panel shall be that determined at its midpoint location.
- (b) All other position 1 hatch covers shall be designed to 2.0 t/m<sup>2</sup>.
- (c) Position 2 hatch covers shall be designed to 1.5 t/m<sup>2</sup>.
- (d) Where a position 1 hatchway is located at least one superstructure standard height higher than the freeboard deck, it may be designed to 2.0 t/m<sup>2</sup>.

(4) For ships between 24 m and 100 m in length, and for positions between FP and 0.25L, wave loads shall be obtained by linear interpolation of the values shown in table 16.2.

	Longitudinal position		
	FP	0.25L	Aft of 0.25L
<b>L &gt; 100 m</b>			
Freeboard deck	Equation in 16(2)(a)	3.5 t/m <sup>2</sup>	3.5 t/m <sup>2</sup>
Superstructure deck	3.5 t/m <sup>2</sup>		2.6 t/m <sup>2</sup>
<b>L = 100 m</b>			
Freeboard deck	5.0 t/m <sup>2</sup>	3.5 t/m <sup>2</sup>	3.5 t/m <sup>2</sup>
Superstructure deck	3.5 t/m <sup>2</sup>		2.6 t/m <sup>2</sup>
<b>L = 24 m</b>			
Freeboard deck	2.43 t/m <sup>2</sup>	2.0 t/m <sup>2</sup>	2.0 t/m <sup>2</sup>
Superstructure deck	2.0 t/m <sup>2</sup>		1.5 t/m <sup>2</sup>

*Table 16.2*

(5) All hatch covers shall be designed such that:

- (a) the product of the maximum stress determined in accordance with the above loads and the factor of 1.25 does not exceed the minimum upper yield point strength of the material in tension and the critical buckling strength in compression;
- (b) the deflection is limited to not more than 0.0056 times the span;

- (c) steel plating forming the tops of covers is not less in thickness than 1% of the spacing of stiffeners or 6 mm if that be greater; and
- (d) an appropriate corrosion margin is incorporated.

*Securing arrangements*

(6) The means for securing and maintaining weathertightness by other means than gaskets and clamping shall be to the satisfaction of the Director or any Recognised Organisation.

(7) Hatch covers which rest on coamings shall be located in their closed position by means capable of withstanding horizontally acting loads in any sea conditions.

*Regulation 17*

*Machinery space openings*

(1) Machinery space openings in position 1 or 2 shall be properly framed and efficiently enclosed by steel casings of ample strength, and where the casings are not protected by other structures their strength shall be specially considered. Access openings in such casings shall be fitted with doors complying with the requirements of regulation 12(1), the sills of which shall be at least 600 mm above the deck if in position 1, and at least 380 mm above the deck if in position 2. Other openings in such casings shall be fitted with equivalent covers, permanently attached in their proper positions.

(2) Where machinery casings are not protected by other structures, double doors (i.e. inner and outer doors complying with the requirements of regulation 12(1)) shall be required for ships assigned freeboards less than those based on table 28.2 of regulation 28. An inner sill of 230 mm in conjunction with the outer sill of 600 mm shall be provided.

(3) Coamings of any fiddley, funnel or machinery space ventilator in an exposed position on the freeboard deck or superstructure deck shall be as high above the deck as is reasonable and practicable. In general, ventilators necessary to continuously supply the machinery space shall have coamings of sufficient height to comply with regulation 19(3), without having to fit weathertight closing appliances. Ventilators necessary to continuously supply the emergency generator room, if this is considered buoyant in the stability calculation or protecting opening leading below, shall have coamings of sufficient height to comply with regulation 19(3), without having to fit weathertight closing appliances.

(4) Where due to ship size and arrangement this is not practicable, lesser heights for machinery space and emergency generator room ventilator coamings, fitted with weathertight closing appliances in accordance with regulation 19(4), may be permitted by the Director or any Recognised Organisation in combination with

other suitable arrangements to ensure an uninterrupted, adequate supply of ventilation to these spaces.

(5) Fiddley openings shall be fitted with strong covers of steel or other equivalent material permanently attached in their proper positions and capable of being secured weathertight.

*Regulation 18*

*Miscellaneous openings in freeboard and superstructure decks*

(1) Manholes and flush scuttles in position 1 or 2 or within superstructures other than enclosed superstructures shall be closed by substantial covers capable of being made watertight. Unless secured by closely spaced bolts, the covers shall be permanently attached.

(2) Openings in freeboard decks other than hatchways, machinery space openings, manholes and flush scuttles shall be protected by an enclosed superstructure, or by a deckhouse or companionway of equivalent strength and weathertightness. Similarly, any such opening in an exposed superstructure deck, in the top of a deckhouse on the freeboard deck which gives access to a space below the freeboard deck or a space within an enclosed superstructure shall be protected by an efficient deckhouse or companionway. Doorways in such companionways or deckhouses that lead or give access to stairways leading below, shall be fitted with doors in accordance with regulation 12(1). Alternatively, if stairways within a deckhouse are enclosed within properly constructed companionways fitted with doors complying with regulation 12(1), the external door need not be weathertight.

(3) Openings in the top of a deckhouse on a raised quarterdeck or superstructure of less than standard height, having a height equal to or greater than the standard quarterdeck height, shall be provided with an acceptable means of closing but need not be protected by an efficient deckhouse or companionway as defined in the regulation, provided that the height of the deckhouse is at least the standard height of a superstructure. Openings in the top of the deck house on a deck house of less than a standard superstructure height may be treated in a similar manner.

(4) In position 1 the height above the deck of sills to the doorways in companionways shall be at least 600 mm. In position 2 it shall be at least 380 mm.

(5) Where access is provided from the deck above as an alternative to access from the freeboard deck in accordance with regulation 3(10)(b), then the height of sills into a bridge or poop shall be 380 mm. The same shall apply to deckhouses on the freeboard deck.

(6) Where access is not provided from above, the height of the sills to doorways in deckhouses on the freeboard deck shall be 600 mm.

(7) Where the closing appliances of access openings in superstructures and deckhouses are not in accordance with regulation 12(1), interior deck openings shall be considered exposed (i.e. situated in the open deck).

*Regulation 19*

*Ventilators*

(1) Ventilators in position 1 or 2 to spaces below freeboard deck or decks of enclosed superstructures shall have coamings of steel or other equivalent material, substantially constructed and efficiently connected to the deck. Ventilators in position 1 shall have coamings of a height of at least 900 mm above the deck; in position 2 the coamings shall be of a height at least 760 mm above the deck. Where the coaming of any ventilator exceeds 900 mm in height it shall be specially supported.

(2) Ventilators passing through superstructures other than enclosed superstructures shall have substantially constructed coamings of steel or other equivalent material at the freeboard deck.

(3) Ventilators in position 1 the coamings of which extend to more than 4.5 m above the deck, and in position 2 the coamings of which extend to more than 2.3 m above the deck, need not be fitted with closing arrangements unless specifically required by the Director or any Recognised Organisation.

(4) Except as provided in paragraph (3), ventilator openings shall be provided with weathertight closing appliances of steel or other equivalent material. In ships of not more than 100 m in length the closing appliances shall be permanently attached; where not so provided in other ships, they shall be conveniently stowed near the ventilators to which they are to be fitted.

(5) In exposed locations, the height of coamings may be increased to the satisfaction of the Director.

*Regulation 20*

*Air pipes*

(1) Where air pipes to ballast and other tanks extend above the freeboard or superstructure decks, the exposed parts of the pipes shall be of substantial construction; the height from the deck to the point where water may have access below shall be at least 760 mm on the freeboard deck and 450 mm on the superstructure deck.

(2) Where these heights may interfere with the working of the ship, a lower height may be approved, provided that the Director or any Recognised Organisation is satisfied that the closing arrangements and other circumstances justify a lower height.

- (3) Air pipes shall be provided with automatic closing devices.
- (4) Pressure-vacuum valves (PV valves) may be accepted on tankers.

*Regulation 21*

*Cargo ports and other similar openings*

(1) Cargo ports and other similar openings in the sides of ships below the freeboard deck shall be fitted with doors so designed as to ensure the same watertightness and structural integrity as the surrounding shell plating. Unless otherwise granted by the Director or any Recognised Organisation, these opening shall open outwards. The number of such openings shall be the minimum compatible with the design and proper working of the ship.

(2) Unless otherwise permitted by the Director or any Recognised Organisation, the lower edge of openings referred to in paragraph (1) shall not be below a line drawn parallel to the freeboard deck at side, which is at its lowest point at least 230 mm above the upper edge of the uppermost load line.

(3) Where it is permitted to arrange cargo ports and other similar openings with their lower edge below the line specified in paragraph (2), additional features shall be fitted to maintain the watertight integrity.

(4) The fitting of a second door of equivalent strength and watertightness is one acceptable arrangement. A leakage detection device shall be provided in the compartment between the two doors. Drainage of this compartment to the bilges, controlled by a readily accessible screw down valve, shall be arranged. The outer door shall open outwards.

(5) Arrangements for bow doors and their inner doors, side doors and stern doors and their securings shall be in compliance with the requirements of a Recognised Organisation.

*Regulation 22*

*Scuppers, inlets and discharges*

- (1)—(a) Discharges led through the shell either from spaces below the freeboard deck or from within superstructures and deckhouses on the freeboard deck fitted with doors complying with the requirements of regulation 12 shall, except as provided in paragraph (2), be fitted with efficient and accessible means for preventing water from passing inboard. Normally each separate discharge shall have one automatic non-return valve with a positive means of closing it from a position above the freeboard deck. Where, the inboard end of the discharge pipe is located at least 0.01L above the Summer Load Line, the discharge may have two automatic non-return valves without positive means of

closing. Where that vertical distance exceeds  $0.02L$ , a single automatic non-return valve without positive means of closing may be accepted. The means for operating the positive action valve shall be readily accessible and provided with an indicator showing whether the valve is open or closed.

- (b) One automatic non-return valve and one sluice valve controlled from above the freeboard deck instead of one automatic non-return valve with a positive means of closing from a position above the freeboard deck, is acceptable.
- (c) Where two automatic non-return valves are required, the inboard valve shall always be accessible for examination under service conditions (i.e., the inboard valve shall be above the level of the Tropical Load Line). If this is not practicable, the inboard valve need not be located above the Tropical Load Line, provided that a locally controlled sluice valve is fitted between the two automatic non-return valves.
- (d) Where sanitary discharges and scuppers lead overboard through the shell in way of machinery spaces, a locally operated positive closing valve at the shell, together with a non-return valve inboard, is acceptable. The controls of the valves shall be in an easily accessible position.
- (e) The position of the inboard end of discharges shall be related to the Summer Timber Load Line when a timber freeboard is assigned.
- (f) The requirements for non-return valves are applicable only to those discharges which remain open during the normal operation of a ship. For discharges which are to be kept closed at sea, a single screw down valve operated from the deck is acceptable.
- (g) Table 22.1 provides the acceptable arrangements of scuppers and discharges.

Discharges coming from enclosed spaces below the freeboard deck or on the freeboard deck			Discharges coming from other spaces		
General requirement Reg. 22(1) where inboard end < 0.01L above SWL	Discharges through machinery space	Alternatives (Reg. 22(1) ) where inboard end		outboard end > 450mm below FB deck or < 600mm above SWL Reg. 22(4)	otherwise Reg. 22(5)
		> 0.01L above SWL	> 0.02L above SWL		
<p>Symbols:</p> <ul style="list-style-type: none"> <li> inboard end of pipes</li> <li> outboard end of pipes</li> <li> pipes terminating on the open deck</li> <li> non return valve without positive means of closing</li> <li> non return valve with positive means of closing controlled locally</li> <li> valve controlled locally</li> <li> remote control</li> <li> normal thickness</li> <li> substantial thickness</li> </ul>					

[S 893/2023 wef 01/01/2024]

Table 22.1

(2) Scuppers led through the shell from enclosed superstructures used for the carriage of cargo shall be permitted only where the edge of the freeboard deck is not immersed when the ship heels 5° either way. In other cases the drainage shall be led inboard in accordance with the requirements of the International Convention for the Safety of Life at Sea in force.

(3) In manned machinery spaces, main and auxiliary sea inlets and discharges in connection with the operation of machinery may be controlled locally. The controls shall be readily accessible and shall be provided with indicators showing whether the valves are open or closed.

(4) Scuppers and discharge pipes originating at any level and penetrating the shell either more than 450 mm below the freeboard deck or less than 600 mm above the Summer Load Line shall be provided with a non-return valve at the shell. This valve, unless required by paragraph (1), may be omitted if the piping is of substantial thickness (see paragraph (7) below).

[S 403/2008 wef 15/08/2008]

(5) Scuppers leading from superstructures or deckhouses not fitted with doors complying with the requirements of regulation 12 shall be led overboard.

(6) All shell fittings and the valves required by this regulation shall be of steel, bronze or other approved ductile material. Valves of ordinary cast iron or similar



material are not acceptable. All pipes to which this regulation refers shall be of steel or other equivalent material to the satisfaction of the Director or any Recognised Organisation.

(7) Scupper and discharge pipes:

(a) For scupper and discharge pipes, where substantial thickness is not required:

- (i) for pipes having an external diameter equal to or less than 155 mm, the thickness shall not be less than 4.5 mm;
- (ii) for pipes having an external diameter equal to or more than 230 mm, the thickness shall not be less than 6 mm.

Intermediate sizes shall be determined by linear interpolation.

(b) For scupper and discharge pipes, where substantial thickness is required:

- (i) for pipes having an external diameter equal to or less than 80 mm, the thickness shall not be less than 7 mm;
- (ii) for pipes having an external diameter of 180 mm, the thickness shall not be less than 10 mm;
- (iii) for pipes having an external diameter equal to or more than 220 mm, the thickness shall not be less than 12.5 mm.

Intermediate sizes shall be determined by linear interpolation.

*Regulation 22-1*

*Garbage chutes*

(1) Two gate valves controlled from the working deck of the chute instead of the non-return valve with a positive means of closing from a position above the freeboard deck which comply with the following requirements are acceptable:

- (a) the lower gate valve shall be controlled from a position above the freeboard deck. An interlock system between the two valves shall be arranged;
- (b) the inboard end shall be located above the waterline formed by an 8.5° heel to port or starboard at a draft corresponding to the assigned summer freeboard, but not less than 1,000 mm above the summer waterline. Where the inboard end exceeds 0.01L above the summer waterline, valve control from the freeboard deck is not required, provided the inboard gate valve is always accessible under service conditions; and

- (c) alternatively, the upper and lower gate valves may be replaced by a hinged weathertight cover at the inboard end of the chute together with a discharge flap. The cover and flap shall be arranged with an interlock so that the discharge flap cannot be operated until the hopper cover is closed.
- (2) The entire chute, including the cover, shall be constructed of material of substantial thickness.
- (3) The controls for the gate valves and/or hinged covers shall be clearly marked: “Keep closed when not in use”.
- (4) Where the inboard end of the chute is below the freeboard deck of a passenger ship or the equilibrium waterlines of a cargo ship to which damage stability requirements apply, then:
  - (a) the inboard end hinged cover/valve shall be watertight;
  - (b) the valve shall be a screw-down non-return valve fitted in an easily accessible position above the deepest load line; and
  - (c) the screw-down non-return valve shall be controlled from a position above the bulkhead deck and provided with open/closed indicators. The valve control shall be clearly marked: “Keep closed when not in use”.

*Regulation 22-2*

*Spurling pipes and cable lockers*

- (1) Spurling pipes and cable lockers shall be watertight up to the deck exposed to weather.
- (2) Where means of access are provided, they shall be closed by a substantial cover and secured by closely spaced bolts.
- (3) Spurling pipes through which anchor cables are led shall be provided with permanently attached closing appliances to minimize water ingress.

*Regulation 23*

*Side Scuttles, and windows and skylights*

- (1) Side scuttles and windows, together with their glasses, deadlights and storm covers<sup>2</sup>, if fitted, shall be of an approved design and substantial construction. Non-metallic frames are not acceptable.

---

<sup>2</sup>Deadlights are fitted to the inside of windows and side scuttles, while storm covers are fitted to the outside of windows, where accessible, and may be hinged or portable.

(2) Side scuttles are defined as being round or oval openings with an area not exceeding  $0.16 \text{ m}^2$ . Round or oval openings having areas exceeding  $0.16 \text{ m}^2$  shall be treated as windows.

(3) Windows are defined as being rectangular openings generally, having a radius at each corner relative to the window size and round or oval openings with an area exceeding  $0.16 \text{ m}^2$ .

(4) Side scuttles to the following spaces shall be fitted with hinged inside deadlights:

- (a) spaces below freeboard deck;
- (b) spaces within the first tier of enclosed superstructures; and
- (c) first tier deckhouses on the freeboard deck protecting openings leading below or considered buoyant in stability calculations.

Deadlights shall be capable of being closed and secured watertight if fitted below the freeboard deck and weathertight if fitted above.

(5) Side scuttles shall not be fitted in such a position that their sills are below a line drawn parallel to the freeboard deck at side and having its lowest point 2.5% of the breadth (B), or 500 mm, whichever is the greatest distance, above the Summer Load Line (or Timber Summer Load Line if assigned).

(6) If the required damage stability calculations indicate that the side scuttles would become immersed at any intermediate stage of flooding or the final equilibrium waterline, they shall be of the non-opening type.

(7) Windows shall not be fitted in the following locations:

- (a) below the freeboard deck;
- (b) in the first tier end bulkheads or sides of enclosed superstructures; or
- (c) in first tier deckhouses that are considered buoyant in the stability calculations.

(8) Side scuttles and windows at the side shell in the second tier shall be provided with hinged inside deadlights capable of being closed and secured weathertight if the superstructure protects direct access to an opening leading below or is considered buoyant in the stability calculations.

(9) Side scuttles and windows in side bulkheads set inboard from the side shell in the second tier which protect direct access below to spaces listed in paragraph (4) shall be provided with either hinged inside deadlights or, where they are accessible, permanently attached external storm covers which are capable of being closed and secured weathertight.

(10) Cabin bulkheads and doors in the second tier and above separating side scuttles and windows from a direct access leading below or the second tier

considered buoyant in the stability calculations may be accepted in place of deadlights or storm covers fitted to the side scuttles and windows.

(11) Deckhouses situated on a raised quarter deck or on the deck of a superstructure of less than standard height may be regarded as being in the second tier as far as the requirements for deadlights are concerned, provided that the height of the raised quarter deck or superstructure is equal to or greater than the standard quarter deck height.

(12) Fixed or opening skylights shall have a glass thickness appropriate to their size and position as required for side scuttles and windows. Skylight glasses in any position shall be protected from mechanical damage and, where fitted in position 1 or 2, shall be provided with permanently attached deadlights or storm covers.

*Regulation 24*

*Freeing ports*

- (1)—(a) Where bulwarks on the weather portions of freeboard or superstructure decks form wells, ample provision shall be made for rapidly freeing the decks of water and for draining them.
- (b) Except as provided in paragraphs (1)(c) and (2), the minimum freeing port area ( $A$ ) on each side of the ship for each well on the freeboard deck shall be that given by the following formulae in cases where the sheer in way of the well is standard or greater than standard.

The minimum area for each well on superstructure decks shall be one-half of the area given by the following formulae:

Where the length of bulwark ( $l$ ) in the well is 20 m or less:

$$A = 0.7 + 0.035 l \text{ m}^2;$$

where  $l$  exceeds 20 m:

$$A = 0.07 l \text{ m}^2.$$

$l$  need in no case be taken as greater than 0.7L.

If the bulwark is more than 1.2 m in average height, the required area shall be increased by 0.004 m<sup>2</sup> per metre of length of well for each 0.1 m difference in height. If the bulwark is less than 0.9 m in average height, the required area may be decreased by 0.004 m<sup>2</sup> per m of length of well for each 0.1 m difference in height.

- (c) In ships with no sheer, the area calculated according to paragraph (b) shall be increased by 50%. Where the sheer is less than the standard, the percentage shall be obtained by linear interpolation.

- (d) On a flush deck ship with a deckhouse amidships having a breadth at least 80% of the beam of the ship and the passageways along the side of the ship not exceeding 1.5 m in width, two wells are formed. Each shall be given the required freeing port area based upon the length of each well.
- (e) Where a screen bulkhead is fitted completely across the ship at the forward end of a midship deckhouse, the exposed deck is divided into two wells and there is no limitation on the breadth of the deckhouse.
- (f) Wells on raised quarterdecks shall be treated as being on freeboard decks.
- (g) Gutter bars greater than 300 mm in height fitted around the weather decks of tankers in way of cargo manifolds and cargo piping shall be treated as bulwarks. Freeing ports shall be arranged in accordance with this regulation. Closures attached to the freeing ports for use during loading and discharge operations are to be arranged in such a way that jamming cannot occur while at sea.

(2) Where a ship fitted with a trunk does not comply with the requirements of regulation 36(1)(e) or where continuous or substantially continuous hatchway side coamings are fitted between detached superstructures, the minimum area of the freeing port openings shall be calculated from the following table:

Breadth of hatchway or trunk in relation to the breadth of ship	Area of freeing ports in relation to the total area of the bulwarks
40% or less	20%
75% or more	10%

The area of freeing ports at intermediate breadths shall be obtained by linear interpolation.

(3) The effectiveness of the freeing area in bulwarks required by paragraph (1) depends on the free flow area across the deck of a ship.

The free flow area on deck is the net area of gaps between hatchways, and between hatchways and superstructures and deckhouses up to the actual height of the bulwark.

The freeing port area in bulwarks shall be assessed in relation to the net free flow area as follows:

- (a) If the free flow area is not less than the freeing area calculated from paragraph (2) as if the hatchway coamings were continuous, then the minimum freeing port area calculated from paragraph (1) shall be deemed sufficient.

- (b) If the free flow area is equal to, or less than the area calculated from paragraph (1), the minimum freeing area in the bulwarks shall be determined from paragraph (2).
- (c) If the free flow area is smaller than calculated from paragraph (2), but greater than calculated from paragraph (1), the minimum freeing area in the bulwark shall be determined from the following formula:

$$F = F_1 + F_2 - f_p \text{ m}^2$$

where:

$F_1$  is the minimum freeing area calculated from paragraph (1);

$F_2$  is the minimum freeing area calculated from paragraph (2); and

$f_p$  is the total net area of passages and gaps between hatch ends and superstructures or deckhouses up to the actual height of bulwark.

(4) In ships having superstructures on the freeboard deck or superstructure decks, which are open at either or both ends to wells formed by bulwarks on the open decks, adequate provision for freeing the open spaces within the superstructures shall be provided.

The minimum freeing port area on each side of the ship for the open superstructure ( $A_s$ ) and for the open well ( $A_w$ ), shall be calculated in accordance with the following procedure:

- (a) Determine the total well length ( $l_t$ ) equal to the sum of the length of the open deck enclosed by bulwarks ( $l_w$ ) and the length of the common space within the open superstructure ( $l_s$ ).
- (b) To determine  $A_s$ :
- (i) calculate the freeing port area ( $A$ ) required for an open well of length  $l_t$  in accordance with paragraph (1) with standard height bulwark assumed;
  - (ii) multiply by a factor of 1.5 to correct for the absence of sheer, if applicable, in accordance with paragraph (1)(c);
  - (iii) multiply by the factor ( $b_o/l_t$ ) to adjust the freeing port area for the breadth ( $b_o$ ) of the openings in the end bulkhead of the enclosed superstructure;
  - (iv) to adjust the freeing port area for that part of the entire length of the well which is enclosed by the open superstructure, multiply by the factor:

$$1 - (l_w / l_t)^2$$

where  $l_w$  and  $l_t$  are defined in paragraph (4)(a);

- (v) to adjust the freeing port area for the distance of the well deck above the freeboard deck, for decks located more than  $0.5 h_s$  above the freeboard deck, multiply by the factor:

$$0.5(h_s / h_w)$$

where  $h_w$  is the distance of the well deck above the freeboard deck and  $h_s$  is one standard superstructure height.

- (c) To determine  $A_w$ :

- (i) the freeing port area for the open well ( $A_w$ ) shall be calculated in accordance with paragraph (b)(i), using  $l_w$  to calculate a nominal freeing port area ( $A'$ ), and then adjusted for the actual height of the bulwark ( $h_b$ ) by the application of one of the following area corrections, whichever is applicable:

for bulwarks greater than 1.2 m in height:

$$A_c = l_w ((h_b - 1.2)/0.10) (0.004) \text{ m}^2$$

for bulwarks less than 0.9 m in height:

$$A_c = l_w ((h_b - 0.9)/0.10) (0.004) \text{ m}^2$$

for bulwarks between 1.2 m and 0.9 m in height there is no correction (i.e.  $A_c = 0$ );

the corrected freeing port area ( $A_w = A' + A_c$ ) shall then be adjusted for absence of sheer, if applicable, and height above freeboard deck as in paragraphs (b)(ii) and (b)(v), using  $h_s$  and  $h_w$ .

- (d) The resulting freeing port areas for the open superstructure ( $A_s$ ) and for the open well ( $A_w$ ) shall be provided along each side of the open space covered by the open superstructure and each side of the open well, respectively.

- (e) The above relationships are summarised by the following equations, assuming  $l_t$ , the sum of  $l_w$  and  $l_s$ , is greater than 20 m:

freeing port area  $A_w$  for the open well:

$$A_w = (0.07l_w + A_c) (\text{sheer correction}) (0.5h_s / h_w);$$

freeing port area  $A_s$  for the open superstructure:

$$A_s = (0.07l_t) (\text{sheer correction}) (b_o/l_t (1 - (l_w/l_t)^2) (0.5h_s / h_w));$$

where  $l_t$  is 20 m or less, the basic freeing port area is  $A = 0.7 + 0.035l_t$  in accordance with paragraph (1).

(5) The lower edges of freeing ports shall be as near the deck as practicable. Two-thirds of the freeing port area required shall be provided in the half of the well nearest the lowest point of the sheer curve. One third of the freeing port area required shall be evenly spread along the remaining length of the well. With zero or little sheer on the exposed freeboard deck or an exposed superstructure deck the freeing port area shall be evenly spread along the length of the well.

(6) All freeing port openings in the bulwarks shall be protected by rails or bars spaced approximately 230 mm apart. If shutters are fitted to freeing ports, ample clearance shall be provided to prevent jamming. Hinges shall have pins or bearings of non-corrodible material. Shutters shall not be fitted with securing appliances.

*Regulation 25*

*Protection of the crew*

(1) The deckhouses used for the accommodation of the crew shall be constructed to an acceptable level of strength.

(2) Guard rails or bulwarks shall be fitted around all exposed decks. The height of the bulwarks or guard rails shall be at least 1 m from the deck, provided that where this height would interfere with the normal operation of the ship, a lesser height may be approved, if the Director or any Recognised Organisation is satisfied that adequate protection is provided.

(3) Guard rails fitted on superstructure and freeboard decks shall have at least three courses. The opening below the lowest course of the guard rails shall not exceed 230 mm. The other courses shall be not more than 380 mm apart. In the case of ships with rounded gunwales the guard rail supports shall be placed on the flat of the deck. In other locations, guardrails with at least two courses shall be fitted. Guard rails shall comply with the following provisions:

- (a) fixed, removable or hinged stanchions shall be fitted about 1.5 m apart. Removable or hinged stanchions shall be capable of being locked in the upright position;
- (b) at least every third stanchion shall be supported by a bracket or stay;
- (c) where necessary for the normal operation of the ship, steel wire ropes may be accepted in lieu of guard rails. Wires shall be made taut by means of turnbuckles; and



(d) where necessary for the normal operation of the ship, chains fitted between two fixed stanchions and/or bulwarks are acceptable in lieu of guard rails.

(4) Satisfactory means for safe passage required by regulation 25-1 (in the form of guard rails, lifelines, gangways or underdeck passages, etc.) shall be provided for the protection of the crew in getting to and from their quarters, the machinery space and any other spaces used in the essential operation of the ship.

(5) Deck cargo carried on any ship shall be so stowed that any opening which is in way of the cargo and which gives access to and from the crew's quarters, the machinery space and all other parts used in the essential operation of the ship can be closed and secured against water ingress. Protection for the crew in the form of guardrails or lifelines shall be provided above the deck cargo if there is no convenient passage on or below the deck of the ship.

*Regulation 25-1*

*Means for safe passage of crew*

(1) The safe passage of crew shall be provided by at least one of the means prescribed in table 25-1.1 below:

Type of ship	Locations of access in ship	Assigned summer freeboard	Acceptable arrangements according to type of freeboard assigned***:			
			Type 'A'	Type 'B-100'	Type 'B-60'	Type 'B' and 'B+'
All ships other than oil tankers*, chemical tankers* and gas carriers*	1.1 Access to midship quarters	≤3,000 mm	(a)	(a)	(a)	(a)
			(b)	(b)	(b)	(b)
	1.1.1 Between poop and bridge, or		(e)	(e)	(c) (i)	(c) (i)
					(e)	(c) (ii)
	1.1.2 Between poop and deckhouse containing living accommodation or navigating equipment, or both.	> 3,000 mm	(a)	(a)	(a)	(d) (i)
			(b)	(b)	(b)	(d) (ii)
			(e)	(e)	(c) (i)	(d) (iii)
					(c) (ii)	(e)
					(e)	(f) (i)
					(f) (i)	(f) (ii)
					(f) (ii)	(f) (iv)
	1.2 Access to ends	≤ 3,000 mm	(a)	(a)	(a)	
	1.2.1 Between poop and bow (if there is no bridge)		(b)	(b)	(b)	
	(c) (i)		(c) (i)	(c) (i)		
1.2.2 Between bridge and bow, or	(e)		(c) (ii)	(c) (ii)		
	(f) (i)		(e)	(e)		
1.2.3 Between a deckhouse containing living accommodation or navigating equipment, or both, and bow, or	> 3,000 mm		(f) (i)	(f) (i)		
			(f) (ii)	(f) (ii)		
1.2.4 In the case of a flush deck ship, between crew accommodation and the forward and after ends of ship.		(a)	(a)	(a)		
		(b)	(b)	(b)		
		(c) (i)	(c) (i)	(c) (i)		
		(d) (i)	(c) (ii)	(c) (ii)		
		(e)	(d) (i)	(c) (iv)		
	(f) (i)	(d) (ii)	(d) (i)			
		(e)	(d) (ii)			
			(f) (i)	(d) (iii)		
			(f) (ii)	(e)		
				(f) (i)		
				(f) (ii)		
				(f) (iv)		

Type of ship	Locations of access in ship	Assigned summer freeboard	Acceptable arrangements according to type of freeboard assigned***:			
			Type 'A'	Type 'B-100'	Type 'B-60'	Type 'B' and 'B+'
Oil tankers*, chemical tankers* and gas carriers*	2.1 Access to bow	$\leq (A_f + H_s)**$	(a) (e) (f) (i) (f) (v)			
	2.1.1 Between poop and bow or					
	2.1.2 Between a deckhouse containing living accommodation or navigating equipment, or both, and bow, or					
	2.1.3 In the case of a flush deck ship, between crew accommodation and the forward ends of ship.	$> (A_f + H_s)**$	(a) (e) (f) (i) (f) (ii)			
2.2 Access to after end  In the case of a flush deck ship, between crew accommodation and the after end of ship.	As required in 1.2.4 for other types of ships					

Table 25 – 1.1

\* Oil tankers, chemical tankers and gas carriers as defined in regulations II-1/2.12, VII/8.2 and VII/11.2, respectively, of the International Convention for the Safety of Life at Sea, 1974, as amended.

\*\*  $A_f$ : the minimum summer freeboard calculated as type 'A' ship regardless of the type freeboard actually assigned.

$H_s$ : the standard height of superstructure as defined in regulation 33.

\*\*\* Arrangements (a) – (f) are described in paragraph (2) below. Locations (i) – (v) are described in paragraph (3) below.

(2) Acceptable arrangements referred to in table 25-1.1 are defined as follows:

- (a) A well lighted and ventilated under-deck passageway (with a clear opening of at least 0.8 m wide and 2 m high), as close as practicable to the freeboard deck, connecting and providing access to the locations in question.
- (b) A permanent and efficiently constructed gangway, fitted at or above the level of the superstructure deck, on or as near as practicable to the centre line of the ship, providing a continuous platform at least 0.6 m in

width and a non-slip surface and with guard rails extending on each side throughout its length. Guard rails shall be at least 1 m high with three courses and constructed as required in regulation 25(3). A foot-stop shall be provided.

- (c) A permanent walkway at least 0.6 m in width, fitted at freeboard deck level and consisting of two rows of guard rails with stanchions spaced not more than 3 m. The number of courses of rails and their spacing shall be in accordance with regulation 25(3). On type 'B' ships, hatchway coamings not less than 0.6 m in height may be accepted as forming one side of the walkway, provided that two rows of guard rails are fitted between the hatchways.
- (d) A wire rope lifeline not less than 10 mm in diameter, supported by stanchions not more than 10 m apart, or a single hand rail or wire rope attached to hatch coamings, continued and supported between hatchways.
- (e) A permanent gangway that is:
  - (i) located at or above the level of the superstructure deck;
  - (ii) located on or as near as practicable to the centre line of the ship;
  - (iii) located so as not to hinder easy access across the working areas of the deck;
  - (iv) providing a continuous platform at least 1 m in width;
  - (v) constructed of fire resistant and non-slip material;
  - (vi) fitted with guard rails extending on each side throughout its length; guard rails shall be at least 1 m high with courses as required by regulation 25(3) and supported by stanchions spaced not more than 1.5 m apart;
  - (vii) provided with a foot-stop on each side;
  - (viii) having openings, with ladders where appropriate, to and from the deck. Openings shall not be more than 40 m apart; and
  - (ix) having shelters set in way of the gangway at intervals not exceeding 45 m if the length of the exposed deck to be traversed exceeds 70 m. Every such shelter shall be capable of accommodating at least one person and be so constructed as to afford weather protection on the forward, port and starboard sides.
- (f) A permanent walkway located at the freeboard deck level, on or as near as practicable to the centre line of the ship, having the same specifications as those for a permanent gangway listed in (e), except

for foot-stops. On type 'B' ships (certified for the carriage of liquids in bulk) with a combined height of hatch coaming and fitted hatch cover of not less than 1 m in height, the hatchway coamings may be accepted as forming one side of the walkway, provided that two rows of guard rails are fitted between the hatchways.

(3) Permitted transverse locations for arrangements in paragraphs (2)(c), (d) and (f) above, where appropriate:

- (i) at or near the centre line of the ship; or fitted on hatchways at or near the centre line of the ship;
- (ii) fitted on each side of the ship;
- (iii) fitted on one side of the ship, provision being made for fitting on either side;
- (iv) fitted on one side of the ship only;
- (v) fitted on each side of the hatchways, as near to the centre line as practicable.

(4)—(a) Where wire ropes are fitted, turnbuckles shall be provided to ensure their tautness.

- (b) Where necessary for the normal operation of the ship, steel wire ropes may be accepted in lieu of guard rails.
- (c) Where necessary for the normal operation of the ship, chains fitted between two fixed stanchions are acceptable in lieu of guard rails.
- (d) Where stanchions are fitted, every third stanchion shall be supported by a bracket or stay.
- (e) Removable or hinged stanchions shall be capable of being locked in the upright position.
- (f) A means of passage over obstructions such as pipes or other fittings of a permanent nature, shall be provided.
- (g) Generally, the width of the gangway or deck-level walkway should not exceed 1.5 m.

(5) For tankers less than 100 m in length, the minimum width of the gangway platform or deck-level walkway fitted in accordance with paragraphs (2)(e) or (f) above, respectively, may be reduced to 0.6 m.

*Regulation 26*

*Special conditions of assignment for type 'A' ships*

*Machinery casings*

(1) Machinery casings on type 'A' ships, as defined in regulation 27, shall be protected by one of the following arrangements:

- (a) an enclosed poop or bridge of at least standard height; or
- (b) a deckhouse of equal height and equivalent strength.

(2) Machinery casings may, however, be exposed if there are no openings giving direct access from the freeboard deck to the machinery space. A door complying with the requirements of regulation 12 is acceptable in the machinery casing, provided that it leads to a space or passageway which is as strongly constructed as the casing and is separated from the stairway to the engine-room by a second weathertight door of steel or other equivalent material.

*Gangway and access*

(3) A fore and aft permanent gangway, constructed in accordance with the provisions of regulation 25-1(2)(e), shall be fitted on type 'A' ships at the level of the superstructure deck between the poop and the midship bridge or deckhouse where fitted. The arrangement contained in regulation 25-1(2)(a) is considered an equivalent means of access to carry out the purpose of the gangway.

(4) Safe access from the gangway level shall be available between separate crew accommodations and also between crew accommodations and the machinery space.

*Hatchways*

(5) Exposed hatchways on the freeboard and forecastle decks or on the tops of expansion trunks on type 'A' ships shall be provided with efficient watertight covers of steel or other equivalent material.

*Freeing arrangements*

(6) Type 'A' ships with bulwarks shall have open rails fitted for at least half the length of the weather deck or other equivalent freeing arrangements. A freeing port area, in the lower part of the bulwarks, of 33% of the total area of the bulwarks, is an acceptable equivalent freeing arrangement. The upper edge of the sheer strake shall be kept as low as practicable.

(7) Where superstructures are connected by trunks, open rails shall be fitted for the whole length of the exposed parts of the freeboard deck.

CHAPTER III

FREEBOARDS

*Regulation 27*

*Types of ships*

(1) For the purposes of freeboard computation, ships shall be divided into type 'A' and type 'B'.

*Type 'A' ships*

(2) A type 'A' ship is one which:

- (a) is designed to carry only liquid cargoes in bulk;
- (b) has a high integrity of the exposed deck with only small access openings to cargo compartments, closed by watertight gasketed covers of steel or equivalent material; and
- (c) has low permeability of loaded cargo compartments.

(3) A type 'A' ship, if over 150 m in length, to which a freeboard less than type 'B' has been assigned, when loaded in accordance with the requirements of paragraph (11), shall be able to withstand the flooding of any compartment or compartments, with an assumed permeability of 0.95, consequent upon the damage assumptions specified in paragraph (12), and shall remain afloat in a satisfactory condition of equilibrium, as specified in paragraph (13). In such a ship, the machinery space shall be treated as a floodable compartment, but with a permeability of 0.85.

(4) A type 'A' ship shall be assigned a freeboard not less than that based on table 28.1.

*Type 'B' ships*

(5) All ships which do not come within the provisions regarding type 'A' ships in paragraphs (2) and (3) shall be considered as type 'B' ships.

(6) Type 'B' ships, which in position 1 have hatch covers which are permitted by the Director or any Recognised Organisation to comply with the requirements of regulation 15, other than paragraph (6) or which are fitted with securing arrangements accepted under the provisions of regulation 16(6), shall be assigned freeboards based upon the values given in table 28.2, increased by the values given in table 27.1:

Freeboard increase over tabular freeboard for type 'B' ships, for ships with hatch covers complying with the provisions of regulation 15 (other than paragraph (6))

Length of ship (m)	Freeboard (mm)	Length of ship (m)	Freeboard (mm)	Length of ship (m)	Freeboard (mm)
108 and below	50	136	159	164	275
		137	164	165	278
109	52	138	170	166	280
110	55	139	175	167	283
111	57	140	181	168	285
112	59	141	186	169	287
113	62	142	191	170	290
114	64	143	196	171	292
115	68	144	201	172	294
116	70	145	206	173	297
117	73	146	210	174	299
118	76	147	215	175	301
119	80	148	219	176	304
120	84	149	224	177	306
121	87	150	228	178	308
122	91	151	232	179	311
123	95	152	236	180	313
124	99	153	240	181	315
125	103	154	244	182	318
126	108	155	247	183	320
127	112	156	251	184	322
128	116	157	254	185	325
129	121	158	258	186	327
130	126	159	261	187	329
131	131	160	264	188	332
132	136	161	267	189	334
133	142	162	270	190	336
134	147	163	273	191	339
135	153				



Length of ship (m)	Freeboard (mm)	Length of ship (m)	Freeboard (mm)	Length of ship (m)	Freeboard (mm)
192	341	196	350	200	358
193	343	197	353		
194	346	198	355		
195	348	199	357		

Freeboards at intermediate lengths of ship shall be obtained by linear interpolation.

Ships above 200 m in length shall be dealt with by the Director or any Recognised Organisation.

*Table 27.1*

(7) Type 'B' ships, which in position 1 have hatchways fitted with hatch covers complying with the requirements of regulation 16(2) through (5), shall, except as provided in paragraphs (8) to (13) inclusive, be assigned freeboards based on table 28.2.

(8) Any type 'B' ship of over 100 m in length may be assigned freeboards less than those required under paragraph (7), provided that, in relation to the amount of reduction granted, the Director or any Recognised Organisation is satisfied that:

- (a) the measures provided for the protection of the crew are adequate;
- (b) the freeing arrangements are adequate;
- (c) the covers in position 1 and 2 comply with the provisions of regulation 16(1) through (5) and (7); and
- (d) the ship, when loaded in accordance with the requirements of paragraph (11), shall be able to withstand the flooding of any compartment or compartments, with an assumed permeability of 0.95, consequent upon the damage assumptions specified in paragraph (12), and shall remain afloat in a satisfactory condition of equilibrium, as specified in paragraph (13). In such a ship, if over 150 m in length, the machinery space shall be treated as a floodable compartment, but with a permeability of 0.85.

(9) In calculating the freeboards for type 'B' ships which comply with the requirements of paragraphs (8), (11), (12) and (13), the values from table 28.2 shall not be reduced by more than 60% of the difference between the tabular values in tables 28.1 and 28.2 for the appropriate ship lengths.

(10)—(a) The reduction in tabular freeboard allowed under paragraph (9) may be increased up to the total difference between the values in table 28.1 and those in table 28.2 on condition that the ship complies with the requirements of:

- (i) regulation 26, other than paragraph (5), as if it were a type ‘A’ ship;
  - (ii) paragraphs (8), (11) and (13); and
  - (iii) paragraph (12), provided that throughout the length of the ship any one transverse bulkhead will be assumed to be damaged, such that two adjacent fore and aft compartments shall be flooded simultaneously, except that such damage will not apply to the boundary bulkheads of a machinery space.
- (b) In such a ship, if over 150 m in length, the machinery space shall be treated as a floodable compartment, but with a permeability of 0.85.

*Initial condition of loading*

(11) The initial condition of loading before flooding shall be determined as follows:

- (a) The ship is loaded to its summer load waterline on an imaginary even keel.
- (b) When calculating the vertical centre of gravity, the following principles apply:
  - (i) homogeneous cargo is carried;
  - (ii) all cargo compartments, except those referred to under sub-paragraph (iii), but including compartments intended to be partially filled, shall be considered fully loaded except that in the case of fluid cargoes each compartment shall be treated as 98% full;
  - (iii) if the ship is intended to operate at its summer load waterline with empty compartments, such compartments shall be considered empty, provided the height of the centre of gravity so calculated is not less than as calculated under sub-paragraph (ii);
  - (iv) 50% of the ship’s total capacity of tanks and spaces fitted to contain each type of consumables and stores is allowed for. It shall be assumed that for each type of liquid at least one transverse pair or a single centreline tank has maximum free surface, and the tank or combination of tanks to be taken into account shall be those where the effect of free surfaces is the greatest; in each tank the centre of gravity of the contents shall be taken at the centre of volume of the tank. The remaining tanks shall be assumed either completely empty or completely filled, and the distribution of consumable liquids between these

tanks shall be effected so as to obtain the greatest possible height above the keel for the centre of gravity;

*[S 430/2014 wef 01/07/2014]*

- (v) ballast water tanks shall normally be considered to be empty and no free surface correction shall be made for them;

*[S 430/2014 wef 01/07/2014]*

- (vi) alternative treatment for free surface may be considered when developing the final condition for application of damage specified in paragraph (12):

- (A) Method 1 (appropriate to virtual corrections). The virtual centre of gravity for the initial condition is determined as follows:

- (AA) the loading condition shall be developed in accordance with sub-paragraphs (i) to (iv);

- (AB) the correction for the free surfaces is added to the vertical centre of gravity;

- (AC) one virtual initial condition with all compartments empty is generated on summer load line draught with level trim, using the vertical centre of gravity from the above loading condition; and

- (AD) the damage cases will be checked for compliance with the damage stability criteria using the above initial condition;

- (B) Method 2 (appropriate to the use of actual free surface moments according to the assumed tank fillings for damage case). The virtual centre of gravity for the initial condition is determined as follows:

- (BA) the loading condition shall be developed in accordance with sub-paragraphs (i) to (iv);

- (BB) one virtual initial condition for each damage case with liquid-filled compartments may be generated on summer load line draught with level trim, using the initial virtual condition with filled compartments generated on summer load line draught with level trim. Using the vertical centre of gravity and free surface correction from the above loading condition, separate calculations for each damage case are performed. Only the

liquid-filled compartments to be damaged are left empty before damage; and

- (BC) the damage cases will be checked for compliance with the damage stability criteria using the above initial conditions (one initial condition for each damage case);

*[S 430/2014 wef 01/07/2014]*

- (vii) weights shall be calculated on the basis of the following values for specific gravities:

salt water	1.025
fresh water	1.000
oil fuel	0.950
diesel oil	0.900
lubricating oil	0.900.

*[S 430/2014 wef 01/07/2014]*

#### *Damage assumptions*

(12) The following principles regarding the character of the assumed damage apply:

- (a) The vertical extent of damage in all cases is assumed to be from the base line upwards without limit.
- (b) The transverse extent of damage is equal to B/5 or 11.5 m, whichever is the lesser, measured inboard from the side of the ship perpendicularly to the centreline at the level of the summer load waterline.
- (c) If damage of a lesser extent than specified in sub-paragraphs (a) and (b) results in a more severe condition, such lesser extent shall be assumed.
- (d) Except where otherwise required by paragraph (10)(a), the flooding shall be confined to a single compartment between adjacent transverse bulkheads, provided that the inner longitudinal boundary of the compartment is not in a position within the transverse extent of assumed damage. Transverse boundary bulkheads of wing tanks, which do not extend over the full breadth of the ship shall be assumed not to be damaged, provided that they extend beyond the transverse extent of assumed damage prescribed in sub-paragraph (b).

If in a transverse bulkhead there are steps or recesses of not more than 3 m in length, located within the transverse extent of assumed damage as defined in

sub-paragraph (b), such transverse bulkhead may be considered intact and the adjacent compartment may be floodable singly. If, however, within the transverse extent of assumed damage there is a step or recess of more than 3 m in length in a transverse bulkhead, the two compartments adjacent to this bulkhead shall be considered as flooded. The step formed by the afterpeak bulkhead and the afterpeak tank top shall not be regarded as a step for the purpose of this regulation.

- (e) Where a main transverse bulkhead is located within the transverse extent of assumed damage and is stepped in way of a double bottom or side tank by more than 3 m, the double bottom or side tanks adjacent to the stepped portion of the main transverse bulkhead shall be considered as flooded simultaneously. If this side tank has openings, into one or several holds, such as grain feeding holes, such hold or holds shall be considered as flooded simultaneously. Similarly, in a ship designed for the carriage of fluid cargoes, if a side tank has openings into adjacent compartments, such adjacent compartments shall be considered as empty and as being flooded simultaneously. This provision is applicable even where such openings are fitted with closing appliances, except in the case of sluice valves fitted in bulkheads between tanks and where the valves are controlled from the deck. Manhole covers with closely spaced bolts are considered equivalent to the unpierced bulkhead, except in the case of openings in topside tanks making the topside tanks common to the holds.
- (f) Where the flooding of any two adjacent fore and aft compartments is envisaged, main transverse watertight bulkheads shall be spaced at least  $\frac{1}{3} L^{2/3}$  or 14.5 m, whichever is the lesser, in order to be considered effective. Where transverse bulkheads are spaced at a lesser distance, one or more of these bulkheads shall be assumed as non-existent in order to achieve the minimum spacing between bulkheads.

#### *Condition of equilibrium*

(13) The condition of equilibrium after flooding shall be regarded as satisfactory provided:

- (a) The final waterline after flooding, taking into account sinkage, heel and trim, is below the lower edge of any opening through which progressive downflooding may take place. Such openings shall include air pipes, ventilators (even if they comply with regulation 19(4)) and openings which are closed by means of weathertight doors (even if they comply with regulation 12) or hatch covers (even if they comply with regulation 16(1) through (5)), and may exclude those openings closed by means of manhole covers and flush scuttles (which comply

with regulation 18), cargo hatch covers of the type described in regulation 27(2), remotely operated sliding watertight doors, hinged watertight access doors with open/closed indication locally and at the navigation bridge, of the quick-acting or single-action type that are normally closed at sea, hinged watertight doors that are permanently closed at sea, and sidescuttles of the non-opening type (which comply with regulation 23). In the case of doors separating a main machinery space from a steering gear compartment, watertight doors may be of a hinged, quick-acting type kept closed at sea whilst not in use, provided also that the lower sill of such doors is above the summer load waterline.

[S 893/2023 wef 01/01/2024]

- (b) If pipes, ducts or tunnels are situated within the assumed extent of damage penetration as defined in paragraph (12)(b), arrangements shall be made so that progressive flooding cannot thereby extend to compartments other than those assumed to be floodable in the calculation for each case of damage.
- (c) The angle of heel due to unsymmetrical flooding does not exceed 15°. If no part of the deck is immersed, an angle of heel of up to 17° may be accepted.
- (d) The metacentric height in the flooded condition is positive.
- (e) When any part of the deck outside the compartment assumed flooded in a particular case of damage is immersed, or in any case where the margin of stability in the flooded condition may be considered doubtful, the residual stability is to be investigated. It may be regarded as sufficient if the righting lever curve has a minimum range of 20° beyond the position of equilibrium with a maximum righting lever of at least 0.1 m within this range. The area under the righting lever curve within this range shall be not less than 0.0175 m.rad. The Director or any Recognised Organisation shall give consideration to the potential hazard presented by protected or unprotected openings which may become temporarily immersed within the range of residual stability.
- (f) The Director or any Recognised Organisation is satisfied that the stability is sufficient during intermediate stages of flooding.
- (g) Compliance with the residual stability criteria specified in sub-paragraphs (a), (c), (d) and (e) above is not required to be demonstrated in service loading conditions using a stability instrument, stability software or other approved method.

[S 430/2014 wef 01/07/2014]

*Ships without means of propulsion*

(14) A lighter, barge or other ship without independent means of propulsion shall be assigned a freeboard in accordance with the provisions of these regulations. Barges which meet the requirements of paragraphs (2) and (3) may be assigned type 'A' freeboards:

- (a) The Director or any Recognised Organisation should especially consider the stability of barges with cargo on the weather deck. Deck cargo can only be carried on barges to which the ordinary type 'B' freeboard is assigned.
- (b) However, in the case of barges which are unmanned, the requirements of regulations 25, 26(3), 26(4) and 39 shall not apply.
- (c) Such unmanned barges which have on the freeboard deck only small access openings closed by watertight gasketed covers of steel or equivalent material may be assigned a freeboard 25% less than those calculated in accordance with these regulations.

*Regulation 28*

*Freeboard tables*

*Type 'A' ships*

- (1) The tabular freeboard for type 'A' ships shall be determined from table 28.1:

*Table 28.1*

*Freeboard table for type 'A' ships*

Length of ship (m)	Freeboard (mm)	Length of ship (m)	Freeboard (mm)	Length of ship (m)	Freeboard (mm)
24	200	45	385	66	653
25	208	46	396	67	666
26	217	47	408	68	680
27	225	48	420	69	693
28	233	49	432	70	706
29	242	50	443	71	720
30	250	51	455	72	733
31	258	52	467	73	746
32	267	53	478	74	760
33	275	54	490	75	773
34	283	55	503	76	786
35	292	56	516	77	800
36	300	57	530	78	814
37	308	58	544	79	828
38	316	59	559	80	841
39	325	60	573	81	855
40	334	61	587	82	869
41	344	62	600	83	883
42	354	63	613	84	897
43	364	64	626	85	911
44	374	65	639	86	926



Length of ship (m)	Freeboard (mm)	Length of ship (m)	Freeboard (mm)	Length of ship (m)	Freeboard (mm)
87	940	124	1528	161	2141
88	955	125	1546	162	2155
89	969	126	1563	163	2169
90	984	127	1580	164	2184
91	999	128	1598	165	2198
92	1014	129	1615	166	2212
93	1029	130	1632	167	2226
94	1044	131	1650	168	2240
95	1059	132	1667	169	2254
96	1074	133	1684	170	2268
97	1089	134	1702	171	2281
98	1105	135	1719	172	2294
99	1120	136	1736	173	2307
100	1135	137	1753	174	2320
101	1151	138	1770	175	2332
102	1166	139	1787	176	2345
103	1181	140	1803	177	2357
104	1196	141	1820	178	2369
105	1212	142	1837	179	2381
106	1228	143	1853	180	2393
107	1244	144	1870	181	2405
108	1260	145	1886	182	2416
109	1276	146	1903	183	2428
110	1293	147	1919	184	2440
111	1309	148	1935	185	2451
112	1326	149	1952	186	2463
113	1342	150	1968	187	2474
114	1359	151	1984	188	2486
115	1376	152	2000	189	2497
116	1392	153	2016	190	2508
117	1409	154	2032	191	2519
118	1426	155	2048	192	2530
119	1442	156	2064	193	2541
120	1459	157	2080	194	2552
121	1476	158	2096	195	2562
122	1494	159	2111	196	2572
123	1511	160	2126	197	2582

Length of ship (m)	Freeboard (mm)	Length of ship (m)	Freeboard (mm)	Length of ship (m)	Freeboard (mm)
198	2592	235	2910	272	3138
199	2602	236	2918	273	3143
200	2612	237	2925	274	3148
201	2622	238	2932	275	3153
202	2632	239	2939	276	3158
203	2641	240	2946	277	3163
204	2650	241	2953	278	3167
205	2659	242	2959	279	3172
206	2669	243	2966	280	3176
207	2678	244	2973	281	3181
208	2687	245	2979	282	3185
209	2696	246	2986	283	3189
210	2705	247	2993	284	3194
211	2714	248	3000	285	3198
212	2723	249	3006	286	3202
213	2732	250	3012	287	3207
214	2741	251	3018	288	3211
215	2749	252	3024	289	3215
216	2758	253	3030	290	3220
217	2767	254	3036	291	3224
218	2775	255	3042	292	3228
219	2784	256	3048	293	3233
220	2792	257	3054	294	3237
221	2801	258	3060	295	3241
222	2809	259	3066	296	3246
223	2817	260	3072	297	3250
224	2825	261	3078	298	3254
225	2833	262	3084	299	3258
226	2841	263	3089	300	3262
227	2849	264	3095	301	3266
228	2857	265	3101	302	3270
229	2865	266	3106	303	3274
230	2872	267	3112	304	3278
231	2880	268	3117	305	3281
232	2888	269	3123	306	3285
233	2895	270	3128	307	3288
234	2903	271	3133	308	3292

Length of ship (m)	Freeboard (mm)	Length of ship (m)	Freeboard (mm)	Length of ship (m)	Freeboard (mm)
309	3295	328	3353	347	3399
310	3298	329	3355	348	3401
311	3302	330	3358	349	3403
312	3305	331	3361	350	3406
313	3308	332	3363	351	3408
314	3312	333	3366	352	3410
315	3315	334	3368	353	3412
316	3318	335	3371	354	3414
317	3322	336	3373	355	3416
318	3325	337	3375	356	3418
319	3328	338	3378	357	3420
320	3331	339	3380	358	3422
321	3334	340	3382	359	3423
322	3337	341	3385	360	3425
323	3339	342	3387	361	3427
324	3342	343	3389	362	3428
325	3345	344	3392	363	3430
326	3347	345	3394	364	3432
327	3350	346	3396	365	3433

Freeboards at intermediate lengths of ship shall be obtained by linear interpolation.

Ships above 365 metres in length shall be dealt with by the Director or any Recognised Organisation.

*Type 'B' ships*

(2) The tabular freeboard for type 'B' ships shall be determined from table 28.2:

*Table 28.2*

*Freeboard table for type 'B' ships*

Length of ship (m)	Freeboard (mm)	Length of ship (m)	Freeboard (mm)	Length of ship (m)	Freeboard (mm)
24	200	55	503	86	996
25	208	56	516	87	1015
26	217	57	530	88	1034
27	225	58	544	89	1054
28	233	59	559	90	1075
29	242	60	573	91	1096
30	250	61	587	92	1116
31	258	62	601	93	1135
32	267	63	615	94	1154
33	275	64	629	95	1172
34	283	65	644	96	1190
35	292	66	659	97	1209
36	300	67	674	98	1229
37	308	68	689	99	1250
38	316	69	705	100	1271
39	325	70	721	101	1293
40	334	71	738	102	1315
41	344	72	754	103	1337
42	354	73	769	104	1359
43	364	74	784	105	1380
44	374	75	800	106	1401
45	385	76	816	107	1421
46	396	77	833	108	1440
47	408	78	850	109	1459
48	420	79	868	110	1479
49	432	80	887	111	1500
50	443	81	905	112	1521
51	455	82	923	113	1543
52	467	83	942	114	1565
53	478	84	960	115	1587
54	490	85	978	116	1609

Length of ship (m)	Freeboard (mm)	Length of ship (m)	Freeboard (mm)	Length of ship (m)	Freeboard (mm)
117	1630	154	2396	191	3116
118	1651	155	2418	192	3134
119	1671	156	2440	193	3151
120	1690	157	2460	194	3167
121	1709	158	2480	195	3185
122	1729	159	2500	196	3202
123	1750	160	2520	197	3219
124	1771	161	2540	198	3235
125	1793	162	2560	199	3249
126	1815	163	2580	200	3264
127	1837	164	2600	201	3280
128	1859	165	2620	202	3296
129	1880	166	2640	203	3313
130	1901	167	2660	204	3330
131	1921	168	2680	205	3347
132	1940	169	2698	206	3363
133	1959	170	2716	207	3380
134	1979	171	2735	208	3397
135	2000	172	2754	209	3413
136	2021	173	2774	210	3430
137	2043	174	2795	211	3445
138	2065	175	2815	212	3460
139	2087	176	2835	213	3475
140	2109	177	2855	214	3490
141	2130	178	2875	215	3505
142	2151	179	2895	216	3520
143	2171	180	2915	217	3537
144	2190	181	2933	218	3554
145	2209	182	2952	219	3570
146	2229	183	2970	220	3586
147	2250	184	2988	221	3601
148	2271	185	3007	222	3615
149	2293	186	3025	223	3630
150	2315	187	3044	224	3645
151	2334	188	3062	225	3660
152	2354	189	3080	226	3675
153	2375	190	3098	227	3690

Length of ship (m)	Freeboard (mm)	Length of ship (m)	Freeboard (mm)	Length of ship (m)	Freeboard (mm)
228	3705	265	4214	302	4654
229	3720	266	4227	303	4665
230	3735	267	4240	304	4676
231	3750	268	4252	305	4686
232	3765	269	4264	306	4695
233	3780	270	4276	307	4704
234	3795	271	4289	308	4714
235	3808	272	4302	309	4725
236	3821	273	4315	310	4736
237	3835	274	4327	311	4748
238	3849	275	4339	312	4757
239	3864	276	4350	313	4768
240	3880	277	4362	314	4779
241	3893	278	4373	315	4790
242	3906	279	4385	316	4801
243	3920	280	4397	317	4812
244	3934	281	4408	318	4823
245	3949	282	4420	319	4834
246	3965	283	4432	320	4844
247	3978	284	4443	321	4855
248	3992	285	4455	322	4866
249	4005	286	4467	323	4878
250	4018	287	4478	324	4890
251	4032	288	4490	325	4899
252	4045	289	4502	326	4909
253	4058	290	4513	327	4920
254	4072	291	4525	328	4931
255	4085	292	4537	329	4943
256	4098	293	4548	330	4955
257	4112	294	4560	331	4965
258	4125	295	4572	332	4975
259	4139	296	4583	333	4985
260	4152	297	4595	334	4995
261	4165	298	4607	335	5005
262	4177	299	4618	336	5015
263	4189	300	4630	337	5025
264	4201	301	4642	338	5035

Length of ship (m)	Freeboard (mm)	Length of ship (m)	Freeboard (mm)	Length of ship (m)	Freeboard (mm)
339	5045	348	5140	357	5230
340	5055	349	5150	358	5240
341	5065	350	5160	359	5250
342	5075	351	5170	360	5260
343	5086	352	5180	361	5268
344	5097	353	5190	362	5276
345	5108	354	5200	363	5285
346	5119	355	5210	364	5294
347	5130	356	5220	365	5303

Freeboards at intermediate lengths of ship shall be obtained by linear interpolation.

Ships above 365 metres in length shall be dealt with by the Director or any Recognised Organisation.

*Regulation 29*

*Correction to the freeboard for ships under 100 m in length*

The tabular freeboard for a type ‘B’ ship of between 24 m and 100 m in length having enclosed superstructures with an effective length of up to 35% of the length of the ship shall be increased by:

$$7.5(100 - L) \left( 0.35 - \frac{E_1}{L} \right) \text{mm}$$

Where L is the length of the ship in m; and

$E_1$  is the effective length E of superstructure in m as defined in regulation 35, but excluding the length of trunks.

*Regulation 30*

*Correction for block coefficient*

Where the block coefficient ( $C_b$ ) exceeds 0.68, the tabular freeboard specified in regulation 28 as modified, if applicable, by regulations 27(8), 27(10) and 29 shall be multiplied by the factor:

$$\frac{C_b + 0.68}{1.36}$$

The block coefficient is not to be taken greater than 1.0.

*Regulation 31*

*Correction for Depth*

(1) Where  $D$  exceeds  $\frac{L}{15}$ , the freeboard shall be increased by  $(D - \frac{L}{15})R$  mm,  $R$  is  $\frac{L}{0.48}$  at lengths less than 120 m and 250 at 120 m length and above.

(2) Where  $D$  is less than  $\frac{L}{15}$ , no reduction shall be made, except in a ship with an enclosed superstructure covering at least 0.6L amidships, with a complete trunk, or combination of detached enclosed superstructures and trunks which extend all fore and aft, where the freeboard shall be reduced at the rate prescribed in paragraph (1).

(3) Where the height of the superstructure or trunk is less than the corresponding standard height, the calculated reduction shall be corrected in the ratio of the height of the actual superstructure or trunk to the applicable standard height, as defined in regulation 33.

*Regulation 32*

*Correction for position of deck line*

Where the actual depth to the upper edge of the deck line is greater or less than  $D$ , the difference between the depths shall be added to or deducted from the freeboard.

*Regulation 32-1*

*Correction for recess in freeboard deck*

(1) Where a recess is arranged in the freeboard deck, and it does not extend to the sides of the ship, the freeboard calculated without regard to the recess shall be corrected for the consequent loss of buoyancy. The correction shall be equal to the value obtained by dividing the volume of the recess by the waterplane area of the ship at 85% of the least moulded depth (see figure 32-1.1).

(2) The correction shall be an addition to the freeboard obtained after all other corrections have been applied, except bow height correction.

(3) Where the freeboard, corrected for lost buoyancy as above, is greater than the minimum geometric freeboard determined on the basis of a moulded depth measured to the bottom of the recess, the latter value may be used.



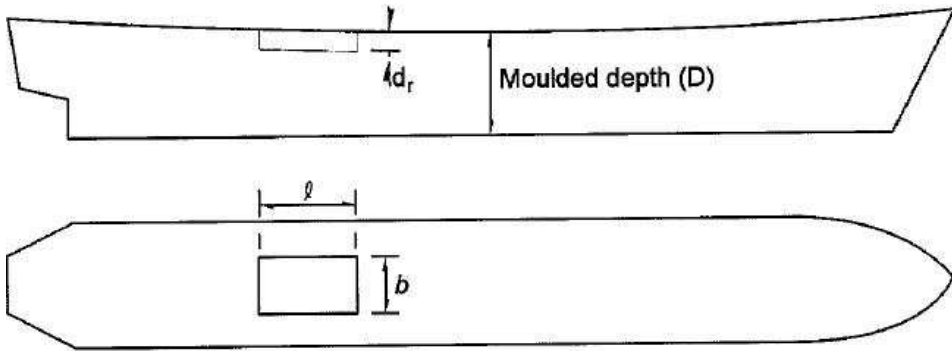

Figure 32-1.1

Correction is the addition to freeboard equal to:

$$\frac{l \times b \times d_r}{\text{WP Area at } 0.85D}$$

Regulation 33

Standard height of superstructure

The standard height of a superstructure shall be as given in the following table:

Standard height (in m)		
L (m)	Raised quarterdeck	All other superstructures
30 or less	0.90	1.80
75	1.20	1.80
125 or more	1.80	2.30

Table 33.1

The standard heights at intermediate lengths of the ship shall be obtained by linear interpolation.

Regulation 34

Length of superstructure

(1) Except as provided in paragraph (2), the length of a superstructure (S) shall be the mean length of the parts of the superstructure which lie within the length (L).

Where a superstructure bulkhead is recessed, the effective length of the superstructure shall be reduced by an amount equal to the area of the recess in plan view divided by the breadth of the superstructure at the mid-length of the recess. Where the recess is unsymmetrical about the centreline, the largest portion of the recess shall be considered as applying to both sides of the ship. A recess need not be decked over.

(2) Where the end bulkhead of an enclosed superstructure extends in a fair convex curve beyond its intersection with the superstructure sides, the length of the superstructure may be increased on the basis of an equivalent plane bulkhead. This increase shall be two-thirds of the fore and aft extent of the curvature. The maximum curvature which may be taken into account in determining this increase is one-half the breadth of the superstructure at the point of intersection of the curved end of the superstructure with its side.

Where there is an extension to a superstructure, which extension has a breadth on each side of the centre line at least 30% of the breadth of the ship, the effective length of the superstructure may be increased by considering an equivalent superstructure bulkhead in the form of a parabola. This parabola shall extend from the extension at the centreline and pass through the junction of the actual superstructure bulkhead with the sides of the extension and extend to the sides of the ship. This parabola shall be completely contained within the boundary of the superstructure and its extensions.

If the superstructure is set-in from the side, up to the limit allowed under regulation 3(10), the equivalent bulkhead should be calculated on the basis of the actual breadth of the superstructure (and not the breadth of the ship).

(3) Superstructures which have sloped end bulkheads shall be dealt with in the following manner:

- (a) When the height of superstructure, clear of the slope, is equal to or smaller than the standard height, length S is to be obtained as shown in figure 34.1.
- (b) When the height is greater than the standard, length S is to be obtained as shown in figure 34.2.
- (c) The foregoing will apply only when the slope, related to the base line, is  $15^\circ$  or greater. Where the slope is less than  $15^\circ$ , the configuration shall be treated as sheer.

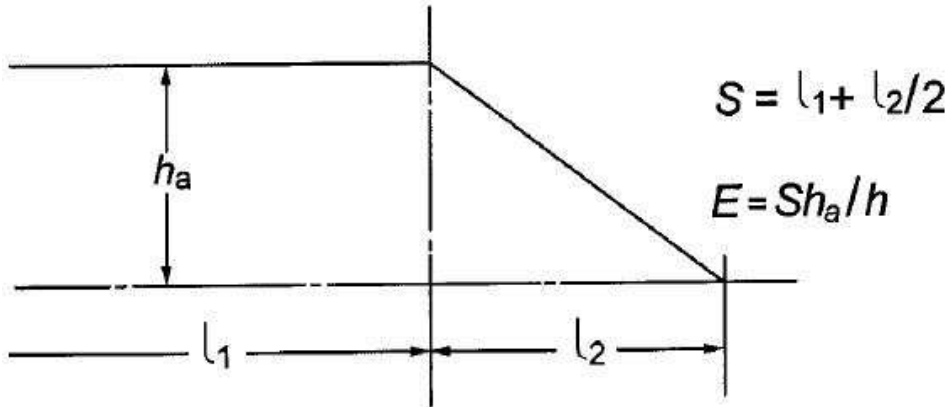

Figure 34.1

Height of superstructure equal to or smaller than the standard height  $h$

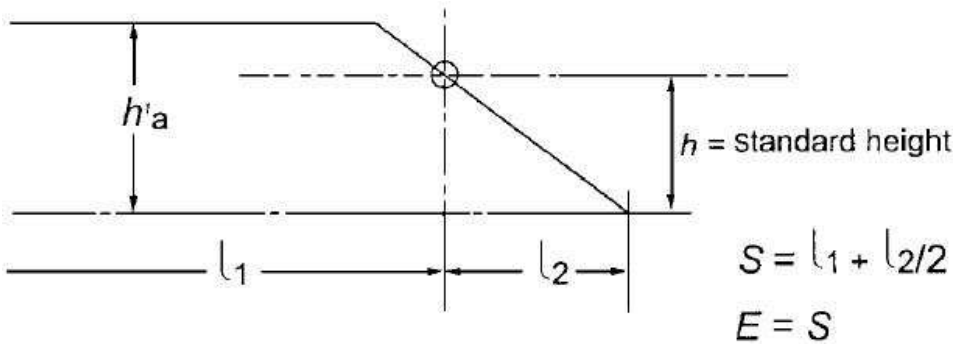

Figure 34.2

Height of superstructure greater than the standard height

Regulation 35

Effective length of superstructure

(1) Except as provided for in paragraph (2), the effective length (E) of an enclosed superstructure of standard height shall be its length.

(2) In all cases where an enclosed superstructure of standard height is set-in from the sides of the ship as permitted in regulation 3(10), the effective length shall be the length modified by the ratio of  $b/B_s$ , where:

$b$  is the breadth of the superstructure at the middle of its length; and

$B_s$  is the breadth of the ship at the middle of the length of the superstructure.

Where a superstructure is set-in for a part of its length, this modification shall be applied only to the set-in part.

(3) Where the height of an enclosed superstructure is less than the standard height, the effective length shall be its length reduced in the ratio of the actual height to the standard height. Where the height exceeds the standard, no increase shall be made to the effective length of the superstructure (see figures 34.1 and 34.2).

Where the height, clear of the slope, of a superstructure which has sloped end bulkheads is less than the standard height, its effective length  $E$  shall be its length  $S$  as obtained from figure 34.1, reduced in the ratio of the actual height to the standard height.

Where a poop or forecastle of less than standard height is fitted on a ship with excessive sheer but without any superstructure within  $0.2L$  amidships, credit may be given to the height of the poop or forecastle by increasing the actual height by the difference between the actual and the standard sheer profiles. The deduction for excess sheer in accordance with regulation 38(16) is not to be granted.

(4) The effective length of a raised quarter deck, if fitted with an intact front bulkhead, shall be its length up to a maximum of  $0.6L$ . Where the bulkhead is not intact, the raised quarter deck shall be treated as a poop of less than standard height.

The maximum effective length of  $0.6L$  of a raised quarterdeck is to be measured from the after perpendicular, even where a poop is fitted in conjunction with the raised quarterdeck.

(5) Superstructures which are not enclosed shall have no effective length.

### *Regulation 36*

#### *Trunks*

(1) A trunk or similar structure which does not extend to the sides of the ship shall be regarded as efficient on the following conditions:

- (a) the trunk is at least as strong as a superstructure;
- (b) the hatchways are in the trunk deck, the hatchway coamings and covers comply with the requirements of regulations 13 to 16 inclusive and the width of the trunk deck stringer provides a satisfactory gangway and sufficient lateral stiffness. However, small access openings with watertight covers may be permitted in the freeboard deck;
- (c) a permanent working platform fore and aft fitted with guard rails is provided by the trunk deck, or by detached trunks connected to superstructures by efficient permanent gangways;

- (d) ventilators are protected by the trunk, by watertight covers or by other equivalent means;
  - (e) open rails are fitted on the weather parts of the freeboard deck in way of the trunk for at least half their length or, alternatively, freeing port area in the lower part of the bulwarks, subject to regulation 24(2), of 33% of the total area of the bulwarks is provided;
  - (f) the machinery casings are protected by the trunk, by a superstructure of at least standard height, or by a deckhouse of the same height and of equivalent strength;
  - (g) the breadth of the trunk is at least 60% of the breadth of the ship; and
  - (h) where there is no superstructure, the length of the trunk is at least 0.6L.
- (2) The full length of an efficient trunk reduced in the ratio of its mean breadth to B shall be its effective length.
- (3) The standard height of a trunk is the standard height of a superstructure other than a raised quarter deck.
- (4) Where the height of a trunk is less than the standard height, its effective length shall be reduced in the ratio of the actual to the standard height. Where the height of hatchway coamings on the trunk deck is less than that required under regulation 14-1, a reduction from the actual height of trunk shall be made which corresponds to the difference between the actual and the required height of coaming.
- (5) Where the trunk height is less than standard and the trunk hatch coamings are also of less than standard height, or omitted entirely, the reduction from the actual height of trunk on account of insufficient hatch coaming height shall be taken as the difference between 600 mm and the actual height of coaming, or 600 mm if no hatch coamings are fitted. Reduction in the actual height of trunk shall not be required in cases where only small hatches with less than standard height are fitted in the trunk deck for which dispensation from the requirement of standard coaming height may be given.
- (6) Continuous hatchways may be treated as a trunk in the freeboard computation, provided the provisions of this paragraph are complied with in all respects. The trunk deck stringer referred to in paragraph (1)(b) may be fitted outboard of the trunk side bulkhead in association with the following:
- (a) the stringer so formed is to provide a clear walkway of at least 450 mm in width on each side of the ship;
  - (b) the stringer is to be of solid plate, efficiently supported and stiffened;
  - (c) the stringer is to be as high above the freeboard deck as practicable. In the freeboard calculation, the trunk height is to be reduced by at least

600 mm or by the actual difference between the top of the trunk and the stringer, whichever is greater;

(d) hatch cover securing appliances are to be accessible from the stringer or walkway; and

(e) the breadth of the trunk is to be measured between the trunk side bulkheads.

(7) Where the trunk adjoining the superstructures such as poop, bridge or forecastle is included in the calculation of freeboard, openings shall not be arranged in that part of the bulkhead which is common for the trunk and superstructure. A relaxation may be made for small openings such as for piping, cable or manholes with covers attached by means of bolts.

(8) The sides of a trunk included in the calculation of freeboard shall be intact. Side scuttles of the non-opening type and bolted manhole covers may be allowed.

Regulation 37

Deduction for superstructure and trunks

(1) Where the effective length of superstructures and trunks is 1.0 L, the deduction from the freeboard shall be 350 mm at 24 m length of ship, 860 mm at 85 m length and 1,070 mm at 122 m length and above. Deductions at intermediate lengths shall be obtained by linear interpolation.

(2) Where the total effective length of superstructures and trunks is less than 1.0 L, the deduction shall be a percentage obtained from the following table:

PERCENTAGE OF DEDUCTION FOR TYPE 'A' AND 'B' SHIPS

	Total effective length of superstructures and trunks										
	0	0.1 L	0.2 L	0.3 L	0.4 L	0.5 L	0.6 L	0.7 L	0.8 L	0.9 L	1.0 L
Percentage of deduction for all types of superstructure	0	7	14	21	31	41	52	63	75.3	87.7	100

Percentages at intermediate lengths of superstructures and trunks shall be obtained by linear interpolation.

Table 37.1

(3) For ships of type 'B' where the effective length of a forecastle is less than 0.07L no deduction is allowed.

Regulation 38

Sheer

General

(1) The sheer shall be measured from the deck at side to a line of reference drawn parallel to the keel through the sheer line amidships.

(2) In ships designed with a rake of keel, the sheer shall be measured in relation to a reference line drawn parallel to the design load waterline.

(3) In flush deck ships and in ships with detached superstructures the sheer shall be measured at the freeboard deck.

(4) In ships with topsides of unusual form in which there is a step or break in the topsides, the sheer shall be considered in relation to the equivalent depth amidships.

(5) In ships with a superstructure of standard height which extends over the whole length of the freeboard deck, the sheer shall be measured at the superstructure deck. Where the height exceeds the standard, the least difference ( $Z$ ) between the actual and standard heights shall be added to each end ordinate. Similarly, the intermediate ordinates at distances of  $1/6L$  and  $1/3L$  from each perpendicular shall be increased by  $0.444Z$  and  $0.111Z$ , respectively. Where there is an enclosed poop or forecastle superimposed on the superstructure, sheer credit shall be allowed for such a poop or forecastle, according to the method of paragraph (12) as shown in figure 38.1.

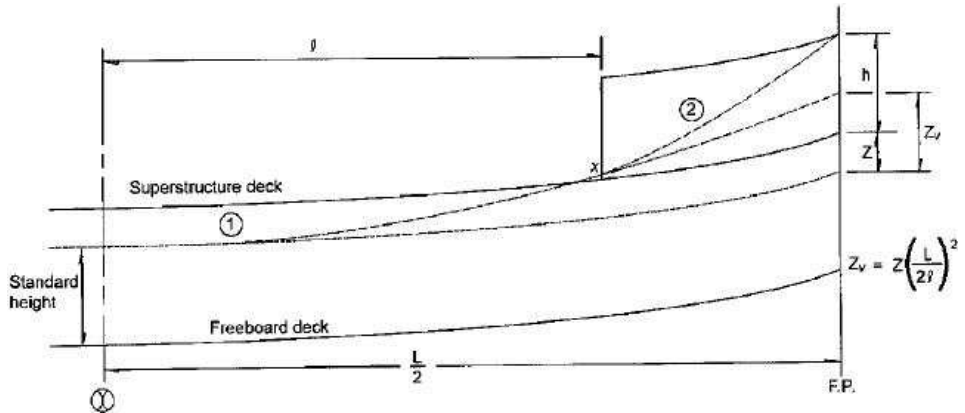

Figure 38.1

(6) Where the deck of an enclosed superstructure has at least the same sheer as the exposed freeboard deck, the sheer of the enclosed portion of the freeboard deck shall not be taken into account.

(7) Where an enclosed poop or forecastle is of standard height with greater sheer than that of the freeboard deck, or is of more than standard height, an addition to the sheer of the freeboard deck shall be made as provided in paragraph (12).

Where a poop or forecastle consists of two layers, the method shown in figure 38.2 shall be used.

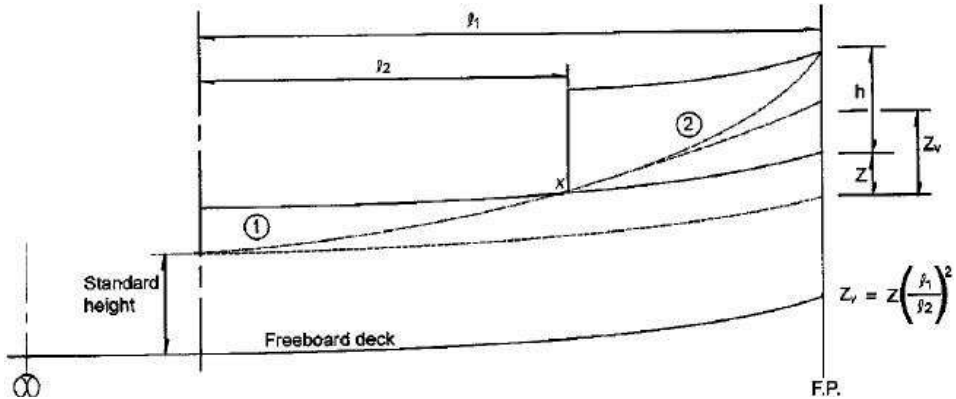

Figure 38.2

In figures 38.1 and 38.2, the following definitions apply:

$Z$  is as defined in paragraph (5); and

$Z_v$  is the end ordinate of a virtual standard parabolic curve taken through the point "X". If  $Z_v$  is greater than  $(Z + h)$ , the end ordinate shall be  $(Z + h)$ , in which case point "X" shall be disregarded and curve (2) not taken into account.

When the length of the first tier superstructure is greater than  $0.5l$ , the virtual standard parabolic curve shall commence at amidships as indicated in figure 38.1.

*Standard sheer profile*

(8) The ordinates of the standard sheer profile are given in the following table:

*Standard sheer profile*

(where  $L$  is in  $m$ )



	Station	Ordinate (in mm)	Factor
After half	After perpendicular	$25 \left( \frac{L}{3} + 10 \right)$	1
	$\frac{1}{6}$ L from A.P.	$11.1 \left( \frac{L}{3} + 10 \right)$	3
	$\frac{1}{3}$ L from A.P.	$2.8 \left( \frac{L}{3} + 10 \right)$	3
	Amidships	0	1
Forward half	Amidships	0	1
	$\frac{1}{3}$ L from F.P.	$5.6 \left( \frac{L}{3} + 10 \right)$	3
	$\frac{1}{6}$ L from F.P.	$22.2 \left( \frac{L}{3} + 10 \right)$	3
	Forward perpendicular	$50 \left( \frac{L}{3} + 10 \right)$	1

Table 38.1

*Measurement of variation from standard sheer profile*

(9) Where the sheer profile differs from the standard, the four ordinates of each profile in the forward or after half shall be multiplied by the appropriate factors given in the above table of ordinates. The difference between the sums of the respective products and those of the standard divided by 8 measures the deficiency or excess of sheer in the forward or after half. The arithmetical mean of the excess or deficiency in the forward and after halves measures the excess or deficiency of sheer.

(10) Where the after half of the sheer profile is greater than the standard and the forward half is less than the standard, no credit shall be allowed for the part in excess and deficiency only shall be measured.

(11) Where the forward half of the sheer profile exceeds the standard, and the after portion of the sheer profile is not less than 75% of the standard, credit shall be allowed for the part in excess. Where the after part is less than 50% of the standard no credit shall be given for the excess sheer forward. Where the after sheer is between 50% and 75% of the standard, intermediate allowances may be granted for excess sheer forward.

(12) Where sheer credit is given for a poop or forecastle the following formula shall be used:

$$s = \frac{yL'}{3L}$$

where:

$s$  is the sheer credit, to be deducted from the deficiency, or added to the excess of sheer;

$y$  is the difference between actual and standard height of superstructure at the after or forward perpendicular;

$L'$  is the mean enclosed length of poop or forecastle up to a maximum length of  $0.5 L$ ; and

$L$  is the length of the ship as defined in regulation 3(1).

The above formula provides a curve in the form of a parabola tangent to the actual sheer curve at the freeboard deck and intersecting the end ordinate at a point below the superstructure deck a distance equal to the standard height of a superstructure. The superstructure deck shall not be less than standard height above this curve at any point. This curve shall be used in determining the sheer profile for forward and after halves of the ship.

(13)—(a) Any excess in the height of a superstructure which does not extend to the after perpendicular cannot be regarded as contributing to the sheer allowance.

(b) Where the height of a superstructure is less than standard, the superstructure deck shall not be less than the minimum height of the superstructure above the virtual sheer curve at any point. For this purpose  $y$  shall be taken as the difference between the actual and minimum height of the superstructure at the after/forward perpendicular.

(c) For a raised quarterdeck credit may be given only when the height of this quarterdeck is greater than the standard height of 'other superstructures' as defined in regulation 33, and only for the amount by which the actual height of the raised quarterdeck exceeds that standard height.

(d) When a poop or a forecastle has sloping end bulkheads, the sheer credit may be allowed on account of excess height. The formula given in paragraph (12) shall be used, the values for  $y$  and  $L'$  being as shown in figure 38.3.

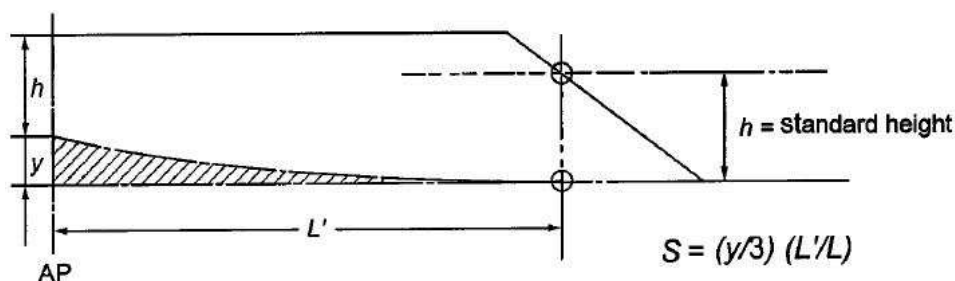

Figure 38.3 Shear credit  $S$  for excess height

*Correction for variations from standard shear profile*

(14) The correction for shear shall be the deficiency or excess of shear (see paragraphs (9) to (11) inclusive), multiplied by

$$0.75 - \frac{S_1}{2L}$$

where  $S_1$  is the total length  $S$  of enclosed superstructures as defined in regulation 34 without trunks.

*Addition for deficiency in shear*

(15) Where the shear is less than the standard, the correction for deficiency in shear (see paragraph (14)) shall be added to the freeboard.

*Deduction for excess shear*

(16) In ships where an enclosed superstructure covers 0.1L before and 0.1L abaft amidships, the correction for excess of shear as calculated under the provisions of paragraph (14) shall be deducted from the freeboard; in ships where no enclosed superstructure covers amidships, no deduction shall be made from the freeboard; where an enclosed superstructure covers less than 0.1L before and 0.1L abaft amidships, the deduction shall be obtained by linear interpolation. The maximum deduction for excess shear shall be at the rate of 125 mm per 100 m of length.

In applying this paragraph, the height of the superstructure shall be related to its standard height. Where the height of the superstructure or raised quarterdeck is less than standard, the reduction shall be in the ratio of the actual to the standard height thereof.

## Regulation 39

*Minimum bow height and reserve buoyancy*

(1) The bow height ( $F_b$ ), defined as the vertical distance at the forward perpendicular between the waterline corresponding to the assigned summer freeboard and the designed trim and the top of the exposed deck at side, shall be not less than:

$$F_b = \left( 6075(L/100) - 1875(L/100)^2 + 200(L/100)^3 \right) \left( 2.08 + 0.609C_b - 1.603C_{wf} - 0.0129(L/d_1) \right)$$

where:

$F_b$  is the calculated minimum bow height, in mm;

$L$  is the length, as defined in regulation 3, in m;

$B$  is the moulded breadth, as defined in regulation 3, in m;

$d_1$  is the draught at 85% of the least moulded depth, in m;

$C_b$  is the block coefficient, as defined in regulation 3;

$C_{wf}$  is the waterplane area coefficient forward of  $L/2$ :

$$C_{wf} = A_{wf} / \{(L/2) \times B\};$$

$A_{wf}$  is the waterplane area forward of  $L/2$  at draught  $d_1$ , in  $m^2$ .

For ships to which timber freeboards are assigned, the summer freeboard (and not the timber summer freeboard) is to be assumed when applying paragraph (1).

[S 403/2008 wef 15/08/2008]

(2) Where the bow height required in paragraph (1) is obtained by sheer, the sheer shall extend for at least 15% of the length of the ship measured from the forward perpendicular. Where it is obtained by fitting a superstructure, such superstructure shall extend from the stem to a point at least 0.07L abaft the forward perpendicular, and shall be enclosed as defined in regulation 3(10).

(3) Ships which, to suit exceptional operational requirements, cannot meet the requirements of paragraphs (1) and (2) of this regulation may be given special consideration by the Director or any Recognised Organisation.

(4)—(a) The sheer of the forecastle deck may be taken into account, even if the length of the forecastle is less than 0.15L, but greater than 0.07L, provided that the forecastle height is not less than one half of standard

height of superstructure as defined in regulation 33 between  $0.07L$  and the forward perpendicular.

- (b) Where the forecastle height is less than one half of the standard height of superstructure, as defined in regulation 33, the credited bow height may be determined as follows:
- (i) Where the freeboard deck has sheer extending from abaft  $0.15L$ , by a parabolic curve having its origin at  $0.15L$  abaft the forward perpendicular at a height equal to the midship depth of the ship, extended through the point of intersection of forecastle bulkhead and deck, and up to a point at the forward perpendicular not higher than the level of the forecastle deck (as illustrated in figure 39.1). However, if the value of the height denoted  $h_t$  in figure 39.1 is smaller than the value of the height denoted  $h_b$  then  $h_t$  may be replaced by  $h_b$  in the available bow height.
  - (ii) Where the freeboard deck has sheer extending for less than  $0.15L$  or has no sheer, by a line from the forecastle deck at side at  $0.07L$  extended parallel to the base line to the forward perpendicular (as illustrated in figure 39.2).

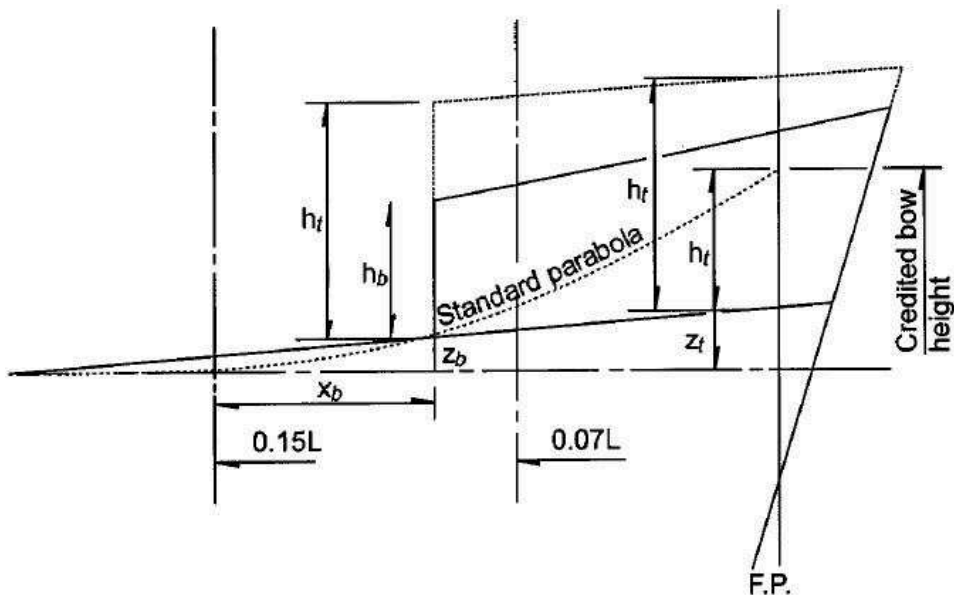

Figure 39.1

$$h_t = Z_b \left( \frac{0.15L}{X_b} \right)^2 - Z_t$$

Figure 39.2

$h_f$  = Half standard height of superstructure as defined in regulation 33.

(5) All ships assigned a type 'B' freeboard, other than oil tankers<sup>3</sup>, chemical tankers<sup>3</sup> and gas carriers<sup>3</sup>, shall have additional reserve buoyancy in the fore end. Within the range of 0.15L abaft of the forward perpendicular, the sum of the projected area between the summer load waterline and the deck at side (A1 and A2 in figure 39.3) and the projected area of an enclosed superstructure, if fitted, (A3) shall not be less than:

$$\left( 0.15F_{\min} + 4(L/3 + 10) \right) L/1000 \text{ m}^2,$$

where:

$F_{\min}$  is calculated by:  $F_{\min} = (F_0 \times f_1) + f_2$ ;

$F_0$  is the tabular freeboard, in mm, taken from table 28.2, corrected for regulation 27(9) or 27(10), as applicable;

$f_1$  is the correction for block coefficient given in regulation 30; and

$f_2$  is the correction for depth, in mm, given in regulation 31.

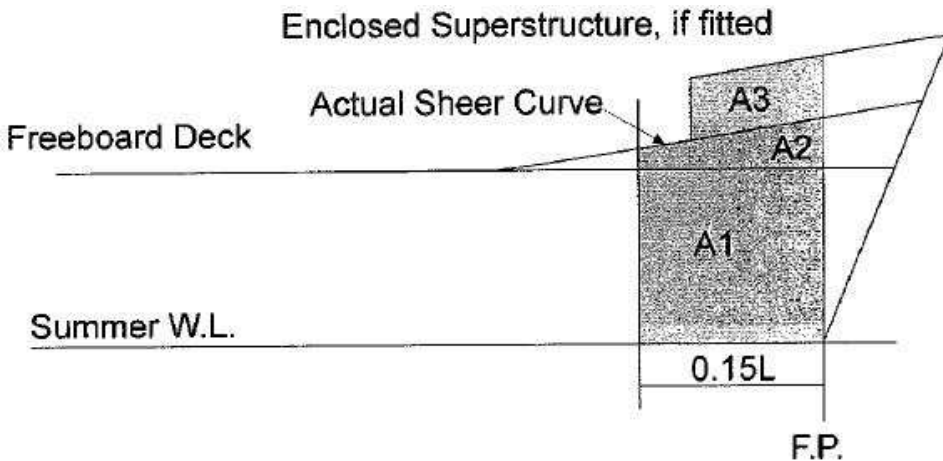

Figure 39.3

<sup>3</sup>Oil tankers, chemical tankers and gas carriers are defined in the International Convention for the Safety of Life at Sea (SOLAS), 1974, regulations II-1/2.12, VII/8.2 and VII/11.2, respectively.

*Regulation 40*

*Minimum freeboards*

*Summer freeboard*

(1) The minimum freeboard in summer shall be the freeboard derived from the tables in regulation 28, as modified by the corrections in regulations 27, as applicable, 29, 30, 31, 32, 37, 38 and, if applicable, 39.

(2) The freeboard in salt water, as calculated in accordance with paragraph (1), but without the correction for deck line, as provided by regulation 32, shall not be less than 50 mm. For ships having in position 1 hatchways with covers which do not comply with the requirements of regulation 16(1) through (5) or regulation 26, the freeboard shall be not less than 150 mm.

*Tropical freeboard*

(3) The minimum freeboard in the Tropical Zone shall be the freeboard obtained by a deduction from the summer freeboard of one forty-eighth of the summer draught measured from the top of the keel to the centre of the ring of the load line mark.

(4) The freeboard in salt water, as calculated in accordance with paragraph (3), but without the correction for deck line, as provided by regulation 32, shall not be less than 50 mm. For ships having in position 1 hatchways with covers which do not comply with the requirements of regulation 16(1) through (5) or regulation 26, the freeboard shall be not less than 150 mm.

*Winter freeboard*

(5) The minimum freeboard in winter shall be the freeboard obtained by an addition to the summer freeboard of one forty-eighth of summer draught, measured from the top of the keel to the centre of the ring of the load line mark.

*Winter North Atlantic freeboard*

(6) The minimum freeboard for ships of not more than 100 m in length which enter any part of the North Atlantic defined in regulation 52 (Annex II) during the winter seasonal period shall be the winter freeboard plus 50 mm. For other ships, the winter North Atlantic freeboard shall be the winter freeboard.

*Fresh water freeboard*

(7) The minimum freeboard in fresh water of unit density shall be obtained by deducting from the minimum freeboard in salt water:

$$\frac{\Delta}{40T} \text{ centimetres}$$

where  $\Delta$  = displacement in salt water in tonnes at the summer load waterline;  
and

T = tonnes per centimetre immersion in salt water at the summer load  
water line.

(8) Where the displacement at the summer load waterline cannot be certified, the deduction shall be one forty-eighth of summer draught, measured from the top of the keel to the centre of the ring of the load line mark.

#### CHAPTER IV

#### SPECIAL REQUIREMENTS FOR SHIPS ASSIGNED TIMBER FREEBOARD

##### *Regulation 41*

##### *Application of this Chapter*

Regulations 42 to 45, inclusive, apply only to ships to which timber load lines are assigned.

##### *Regulation 42*

##### *Definitions*

(1) *Timber deck cargo.* The term “timber deck cargo” means a cargo of timber carried on an uncovered part of a freeboard deck. The term does not include wood pulp or similar cargo<sup>4</sup>.

(2) *Timber load line.* A timber deck cargo may be regarded as giving a ship a certain additional buoyancy and a greater degree of protection against the sea. For that reason, ships carrying a timber deck cargo may be granted a reduction of freeboard calculated according to the provisions of regulation 45 and marked on the ship’s side in accordance with the provisions of regulations 6(3) and (4). However, in order that such special freeboard may be granted and used, the timber deck cargo shall comply with certain conditions which are laid down in regulation 44, and the ship itself shall also comply with certain conditions relating to its construction which are set out in regulation 43.

---

<sup>4</sup>Reference is made to the *Code of Safe Practice for Ships Carrying Timber Deck Cargoes*, adopted by the Organisation by resolution A.715(17), as amended.



*Regulation 43*

*Construction of the ship*

*Superstructure*

(1) Ships shall have a forecastle of at least standard height and a length of at least 0.07L. In addition, if the ship is less than 100 m in length, a poop of at least standard height, or a raised quarterdeck with a deckhouse of at least the same total height shall be fitted aft.

*Double bottom tanks*

(2) Double bottom tanks, where fitted within the midship half length of the ship, shall have adequate watertight longitudinal subdivision.

*Bulwarks*

(3) The ship shall be fitted either with permanent bulwarks at least 1 m in height, specially stiffened on the upper edge and supported by strong bulwark stays attached to the deck and provided with necessary freeing ports, or with efficient rails of the same height and of specially strong construction.

*Regulation 44*

*Stowage*

*General*

(1) Openings in the deck exposed to weather over which cargo is stowed shall be securely closed and battened down.

The ventilators and air pipes shall be efficiently protected.

(2) Timber deck cargoes shall extend over at least the entire available length which is the total length of the well or wells between superstructures.

Where there is no limiting superstructure at the after end, the timber shall extend at least to the after end of the aftermost hatchway.

The timber deck cargo shall extend athwartships as close as possible to the ship's side, due allowance being made for obstructions such as guard rails, bulwark stays, uprights, pilot access, etc., provided that any gap thus created at the side of the ship shall not exceed a mean of 4% of the breadth. The timber shall be stowed as solidly as possible to at least the standard height of the superstructure other than any raised quarterdeck.

(3) On a ship within a seasonal winter zone in winter, the height of the deck cargo above the deck exposed to weather shall not exceed one third of the extreme breadth of the ship.

(4) The timber deck cargo shall be compactly stowed, lashed and secured. It shall not interfere in any way with the navigation and necessary work of the ship.

*Uprights*

(5) Uprights, when required by the nature of the timber, shall be of adequate strength considering the breadth of the ship; the strength of the uprights shall not exceed the strength of the bulwark and the spacing shall be suitable for the length and character of timber carried, but shall not exceed 3 m. Strong angles or metal sockets or equally efficient means shall be provided for securing the uprights.

*Lashings*

(6) Timber deck cargo shall be effectively secured throughout its length by a lashing system acceptable to the Director or any Recognised Organisation for the character of the timber carried<sup>5</sup>.

*Stability*

(7) Provision shall be made for a safe margin of stability at all stages of the voyage, regard being given to additions of weight, such as those arising from absorption of water or icing, if applicable, and to losses of weight such as those arising from consumption of fuel and stores.

*Protection of crew, access to machinery spaces, etc.*

(8) In addition to the requirements of regulation 25(5), guard-rails or lifelines not more than 350 mm apart vertically shall be provided on each side of the cargo deck to a height of at least 1 m above the cargo.

In addition a lifeline, preferably wire rope set up taut with a stretching screw, shall be provided as near as practicable to the centreline of the ship. The stanchion supports to all guard-rails and lifelines shall be so spaced as to prevent undue sagging. Where the cargo is uneven, a safe walking surface of not less than 600 mm in width shall be fitted over the cargo and effectively secured beneath or adjacent to the lifeline.

(9) Where the requirements prescribed in paragraph (8) are impracticable, alternative arrangements satisfactory to the Director or any Recognised Organisation shall be used.

*Steering arrangements*

(10) Steering arrangements shall be effectively protected from damage by cargo and, as far as practicable, shall be accessible. Efficient provision shall be made for steering in the event of a breakdown in the main steering arrangements.

---

<sup>5</sup>Reference is made to the *Code of Safe Practice for Ships Carrying Timber Deck Cargoes*, adopted by the Organisation by resolution A.715(17), as amended.

*Regulation 45*

*Computation for freeboard*

(1) The minimum summer freeboards shall be computed in accordance with regulations 27(5), 27(6), 27(14), 28, 29, 30, 31, 32, 37 and 38, except that regulation 37 is modified by substituting the following percentages for those given in regulation 37:

	Total effective length of superstructure										
	0	0.1 L	0.2 L	0.3 L	0.4 L	0.5 L	0.6 L	0.7 L	0.8 L	0.9 L	1.0 L
Percentage of deduction for all types of superstructure	20	31	42	53	64	70	76	82	88	94	100

Percentages at intermediate lengths of superstructures shall be obtained by linear interpolation.

*Table 45.1*

(2) The Winter Timber Freeboard shall be obtained by adding to the Summer Timber Freeboard one thirty-sixth of the moulded summer timber draught.

(3) The Winter North Atlantic Timber Freeboard shall be the same as the Winter North Atlantic Freeboard prescribed in regulation 40(6).

(4) The Tropical Timber Freeboard shall be obtained by deducting from the Summer Timber Freeboard one forty-eighth of the moulded summer timber draught.

(5) The Fresh Water Timber Freeboard shall be computed in accordance with regulation 40(7), based on the summer timber load waterline or with regulation 40(8), based on the summer timber draught measured from the top of the keel to the summer timber load line.

(6) Timber freeboards may be assigned to ships with reduced type 'B' freeboards, provided the timber freeboards are calculated on the basis of the ordinary type 'B' freeboard.

(7) The Timber Winter mark and/or the Timber Winter North Atlantic mark shall be placed at the same level as the reduced type 'B' Winter mark when the computed Timber Winter mark and/or the computed Timber Winter North Atlantic mark fall below the reduced type 'B' Winter mark.

*[S 12/2005 wef 06/01/2005]*

## ANNEX II

## ZONES, AREAS AND SEASONAL PERIODS

The zones and areas in this Annex are, in general, based on the following criteria:

- Summer — not more than 10 per cent winds of force 8 Beaufort (34 knots) or more.
- Tropical — not more than 1 per cent winds of force 8 Beaufort (34 knots) or more. Not more than one tropical storm in 10 years in an area of 5° square in any one separate calendar month.

In certain special areas, for practical reasons, some degree of relaxation has been found acceptable.

A chart is attached to this Annex to illustrate the zones and areas defined below.

*Regulation 46**Northern Winter Seasonal Zones and Area*(1) *North Atlantic Winter Seasonal Zones I and II*

- (a) The North Atlantic Winter Seasonal Zone I lies within the meridian of longitude 50°W from the coast of Greenland to latitude 45°N, thence the parallel of latitude 45°N to longitude 15°W, thence the meridian of longitude 15°W to latitude 60°N, thence the parallel of latitude 60°N to the Greenwich Meridian, thence this meridian northwards.

Seasonal periods:

WINTER: 16 October to 15 April

SUMMER: 16 April to 15 October

- (b) The North Atlantic Winter Seasonal Zone II lies within the meridian of longitude 68°30'W from the coast of the United States to latitude 40°N, thence the rhumb line to the point latitude 36°N, longitude 73°W, thence the parallel of latitude 36°N to longitude 25°W and thence the rhumb line to Cape Toriñana.

Excluded from this zone are the North Atlantic Winter Seasonal Zone I, the North Atlantic Winter Seasonal Area and the Baltic Sea bounded by the parallel of latitude of the Skaw in the Skagerrak. The Shetland Islands are to be considered as being on the boundary of the North Atlantic Winter Seasonal Zones I and II.

Seasonal periods:

WINTER: 1 November to 31 March

SUMMER: 1 April to 31 October.

(2) *North Atlantic Winter Seasonal Area*

The boundary of the North Atlantic Winter Seasonal Area is —

the meridian of longitude 68°30'W from the coast of the United States to latitude 40°N, thence the rhumb line to the southernmost intersection of the meridian of longitude 61°W with the coast of Canada and thence the east coasts of Canada and the United States.

Seasonal periods:

For ships over 100 metres (328 feet) in length:

WINTER: 16 December to 15 February

SUMMER: 16 February to 15 December

For ships of 100 metres (328 feet) and under in length:

WINTER: 1 November to 31 March

SUMMER: 1 April to 31 October

(3) *North Pacific Winter Seasonal Zone*

The southern boundary of the North Pacific Winter Seasonal Zone is —

the parallel of latitude 50°N from the east coast of the USSR to the west coast of Sakhalin, thence the west coast of Sakhalin to the southern extremity of Cape Kril'on, thence the rhumb line to Wakkanai, Hokkaido, Japan, thence the east and south coasts of Hokkaido to longitude 145°E, thence the meridian of longitude 145°E to latitude 35°N, thence the parallel of latitude 35°N to longitude 150°W and thence the rhumb line to the southern extremity of Dall Island, Alaska.

Seasonal periods:

WINTER: 16 October to 15 April

SUMMER: 16 April to 15 October

*Regulation 47*

*Southern Winter Seasonal Zone*

The northern boundary of the Southern Winter Seasonal Zone is —

the rhumb line from the east coast of the American continent at Cape Tres Puntas to the point latitude 34°S, longitude 50°W, thence the parallel of latitude 34°S to longitude 16°E, thence the rhumb line to the point latitude 36°S, longitude 20°E, thence the rhumb line to the point latitude 34°S, longitude 30° E, thence along the rhumb line to the point latitude 35°30'S, longitude 118°E, and thence the rhumb line to Cape Grim on the north-west coast of Tasmania; thence along the north and east coasts of Tasmania to the southernmost point of Bruny Island, thence the rhumb line to Black Rock Point on Stewart Island, thence the rhumb line to the point latitude 47°S, longitude 170°E, thence along the rhumb line to the point latitude 33°S, longitude 170°W, and thence the parallel of latitude 33°S to the point latitude 33°S, longitude 79°W, thence the rhumb line to the point latitude 41°S, longitude 75°W, thence the rhumb line to Punta Corona lighthouse on Chiloe Island, latitude 41°47'S, longitude 73°53'W, thence along the north, east and south coasts of Chiloe Island to the point latitude 43°20'S, longitude 74°20'W, and thence the meridian of longitude 74°20'W to the parallel of latitude 45°45'S, including the inner zone of Chiloe channels from the meridian 74°20'W to the east.

Seasonal periods:

WINTER: 16 April to 15 October

SUMMER: 16 October to 15 April

[S 834/2013 wef 01/01/2014]

#### *Regulation 48*

##### *Tropical Zone*

##### *(1) Northern Boundary of the Tropical Zone*

The northern boundary of the Tropical Zone is —

the parallel of latitude 13°N from the east coast of the American continent to longitude 60°W, thence the rhumb line to the point latitude 10°N, longitude 58°W, thence the parallel of latitude 10°N to longitude 20°W, thence the meridian of longitude 20°W to latitude 30°N and thence the parallel of latitude 30°N to the west coast of Africa; from the east coast of Africa the parallel of latitude 8°N to longitude 70°E, thence the meridian of longitude 70°E to latitude 13°N, thence the parallel

of latitude 13°N to the west coast of India; thence the south coast of India to latitude 10°30'N on the east coast of India, thence the rhumb line to the point latitude 9°N, longitude 82°E, thence the meridian of longitude 82°E to latitude 8°N, thence the parallel of latitude 8°N to the west coast of Malaysia, thence the coast of South-East Asia to the east coast of Viet-Nam at latitude 10°N, thence the parallel of latitude 10°N to longitude 145°E, thence the meridian of longitude 145°E to latitude 13°N and thence the parallel of latitude 13°N to the west coast of the American continent.

Saigon is to be considered as being on the boundary line of the Tropical Zone and the Seasonal Tropical Area.

(2) *Southern Boundary of the Tropical Zone*

The southern boundary of the Tropical Zone is —

the rhumb line from the Port of Santos, Brazil, to the point where the meridian of longitude 40°W intersects the Tropic of Capricorn; thence the Tropic of Capricorn to the west coast of Africa; from the east coast of Africa the parallel of latitude 20° S to the west coast of Madagascar, thence the west and north coasts of Madagascar to longitude 50°E, thence the meridian of longitude 50°E to latitude 10°S, thence the parallel of latitude 10°S to longitude 98°E, thence the rhumb line to Port Darwin, Australia, thence the coasts of Australia and Wessel Island eastwards to Cape Wessel, thence the parallel of latitude 11°S to the west side of Cape York; from the east side of Cape York the parallel of latitude 11°S to longitude 150°W, thence the rhumb line to the point latitude 26°S, longitude 75°W, thence the rhumb line to the point latitude 32°47'S, longitude 72°W, and thence to the parallel of latitude 32°47'S to the west coast of South America.

Valparaiso and Santos are to be considered as being on the boundary line of the Tropical and Summer Zones.

(3) *Areas to be included in the Tropical Zone*

The following areas are to be treated as included in the Tropical Zone —

- (a) The Suez Canal, the Red Sea and the Gulf of Aden, from Port Said to the meridian of longitude 45°E.

Aden and Berbera are to be considered as being on the boundary line of the Tropical Zone and the Seasonal Tropical Area.

- (b) The Persian Gulf to the meridian of longitude 59°E.
- (c) The area bounded by the parallel of latitude 22°S from the east coast of Australia to the Great Barrier Reef, thence the Great Barrier Reef to latitude 11°S. The northern boundary of the area is the southern boundary of the Tropical Zone.

*Regulation 49*

*Seasonal Tropical Areas*

The following are Seasonal Tropical Areas:

(1) *In the North Atlantic*

An Area bounded —

on the north by the rhumb line from Cape Catoche, Yucatan, to Cape San Antonio, Cuba, the north coast of Cuba to latitude 20°N and thence the parallel of latitude 20°N to longitude 20° W; on the west by the coast of the American continent; on the south and east by the northern boundary of the Tropical Zone.

Seasonal periods:

TROPICAL: 1 November to 15 July

SUMMER: 16 July to 31 October

(2) *In the Arabian Sea*

An area bounded —

on the west by the coast of Africa, the meridian of longitude 45°E in the Gulf of Aden, the coast of South Arabia and the meridian of longitude 59°E in the Gulf of Oman; on the north and east by the coasts of Pakistan and India; on the south by the northern boundary of the Tropical Zone.

Seasonal periods:

TROPICAL: 1 September to 31 May

SUMMER: 1 June to 31 August

(3) *In the Bay of Bengal*

The Bay of Bengal north of the northern boundary of the Tropical Zone.

Seasonal periods:

TROPICAL: 1 December to 30 April



SUMMER: 1 May to 30 November

(4) *In the South Indian Ocean*

(a) An area bounded —

on the north and west by the southern boundary of the Tropical Zone and the east coast of Madagascar;

on the south by the parallel of latitude 20°S;

on the east by the rhumb line from the point latitude 20°S, longitude 50°E, to the point latitude 15°S, longitude 51°30'E, and thence by the meridian of longitude 51°30'E to latitude 10°S.

Seasonal periods:

TROPICAL: 1 April to 30 November

SUMMER: 1 December to 31 March

(b) An area bounded —

on the north by the southern boundary of the Tropical Zone;

on the east by the coast of Australia;

on the south by the parallel of latitude 15°S from longitude 51°30'E, to longitude 114°E and thence the meridian of longitude 114°E to the coast of Australia;

on the west by the meridian of longitude 51°30'E.

Seasonal periods:

TROPICAL: 1 May to 30 November

SUMMER: 1 December to 30 April

(5) *In the China Sea*

An area bounded —

on the west and north by the coasts of Viet-Nam and China from latitude 10°N to Hong Kong;

on the east by the rhumb line from Hong Kong to the Port of Sual (Luzon Island) and the west coasts of the Islands of Luzon, Samar and Leyte to latitude 10°N;

on the south by the parallel of latitude 10°N;

Hong Kong and Sual are to be considered as being on the boundary of the Seasonal Tropical Area and Summer Zone.

Seasonal periods:

TROPICAL: 21 January to 30 April

SUMMER: 1 May to 20 January

(6) *In the North Pacific*

(a) An area bounded —

on the north by the parallel of latitude 25°N;

on the west by the meridian of longitude 160°E;

on the south by the parallel of latitude 13°N;

on the east by the meridian of longitude 130°W.

Seasonal periods:

TROPICAL: 1 April to 31 October

SUMMER: 1 November to 31 March

(b) An area bounded —

on the north and east by the west coast of the American continent;

on the west by the meridian of longitude 123°W from the coast of the American continent to latitude 33°N and by the rhumb line from the point latitude 33°N, longitude 123°W, to the point latitude 13°N, longitude 105°W;

on the south by the parallel of latitude 10°N.

Seasonal periods:

TROPICAL: 1 March to 30 June and

1 November to 30 November

SUMMER: 1 July to 31 October and

1 December to 28/29 February

(7) *In the South Pacific*

(a) The Gulf of Carpentaria south of latitude 11°S.

Seasonal periods:

TROPICAL: 1 April to 30 November

SUMMER: 1 December to 31 March

(b) An area bounded —

on the north and east by the southern boundary of the Tropical Zone;

on the south by the parallel of latitude of 24°S from the east coast of Australia to longitude 154°E, thence by the meridian of longitude 154°E to the Tropic of Capricorn and thence by the Tropic of Capricorn to longitude 150°W, thence by the meridian of longitude 150°W to latitude 20°S and thence by the parallel of latitude 20°S to the point where it intersects the southern boundary of the Tropical Zone; and

on the west by the boundaries of the area within the Great Barrier Reef included in the Tropical Zone and by the east coast of Australia.

Seasonal periods:

TROPICAL: 1 April to 30 November

SUMMER: 1 December to 31 March

[S 12/2005 wef 06/01/2005]

*Regulation 50*

*Summer Zones*

The remaining areas constitute the Summer Zones.

However, for ships of 100 metres (328 feet) and under in length, the area bounded —

on the north and west by the east coast of the United States;

on the east by the meridian of longitude 68°30'W from the coast of the United States to latitude 40°N and thence by the rhumb line to the point latitude 36°N, longitude 73°W; on the south by the parallel of latitude 36°N; is a Winter Seasonal Area.

Seasonal periods:

WINTER: 1 November to 31 March

SUMMER: 1 April to 31 October

*Regulation 51*

*Enclosed Seas*

(1) *Baltic Sea*

This sea bounded by the parallel of latitude of The Skaw in the Skagerrak is included in the Summer Zones.

However, for ships of 100 metres (328 feet) and under in length, it is a Winter Seasonal Area.

Seasonal periods:

WINTER: 1 November to 31 March

SUMMER: 1 April to 31 October

(2) *Black Sea*

This sea is included in the Summer Zones.

However, for ships of 100 metres (328 feet) and under in length, the area north of latitude 44°N is a Winter Seasonal Area.

Seasonal periods:

WINTER: 1 December to 28/29 February

SUMMER: 1 March to 30 November

(3) *Mediterranean*

This sea is included in the Summer Zones.

However, for ships of 100 metres (328 feet) and under in length, the area bounded —

on the north and west by the coasts of France and Spain and the meridian of longitude 3°E from the coast of Spain to latitude 40°N;

on the south by the parallel of latitude 40°N from longitude 3°E to the west coast of Sardinia;

on the east by the west and north coasts of Sardinia from latitude 40°N to longitude 9°E, thence by the meridian of longitude 9°E to the south coast of Corsica, thence by the west and north coasts of Corsica to longitude 9°E and thence by the rhumb line to Cape Sicié; is a Winter Seasonal Area.

Seasonal periods:

WINTER: 16 December to 15 March

SUMMER: 16 March to 15 December

(4) *Sea of Japan*

This sea south of latitude 50°N is included in the Summer Zones.

However, for ships of 100 metres (328 feet) and under in length, the area between the parallel of latitude 50°N and the rhumb line from the east coast of Korea at latitude 38°N to the west coast of Hokkaido, Japan, at latitude 43° 12'N is a Winter Seasonal Area.

Seasonal periods:

WINTER: 1 December to 28/29 February

SUMMER: 1 March to 30 November

*Regulation 52*

*The Winter North Atlantic Load Line*

The part of the North Atlantic referred to in regulation 40(6) (Annex I) comprises:

- (a) that part of the North Atlantic Winter Seasonal Zone II which lies between the meridians of 15°W and 50°W;
- (b) the whole of the North Atlantic Winter Seasonal Zone I, the Shetland Islands to be considered as being on the boundary.

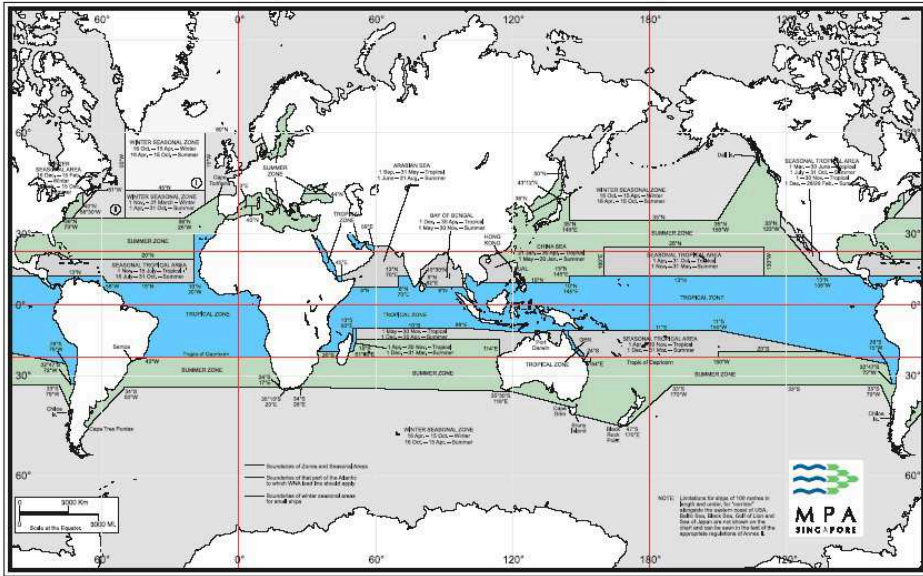

Chart of Zones and Seasonal Areas

[S 12/2005 wef 06/01/2005]

ANNEX III

Regulation 18

CERTIFICATES

FORM A

MERCHANT SHIPPING ACT  
(CHAPTER 179)

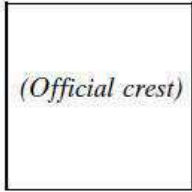

**INTERNATIONAL LOAD LINE CERTIFICATE**  
REPUBLIC OF SINGAPORE  
Issued under the provisions of the  
INTERNATIONAL CONVENTION ON LOAD LINES, 1966,  
as modified by the Protocol of 1988 relating thereto  
under the authority of the Government of the Republic of Singapore  
by

(person or organization authorised)

Particulars of ship

Name of Ship	Official Number	Port of Registry	Length (L) as defined in article 2 (8) (in metres)

IMO Number: \_\_\_\_\_

Freeboard assigned as:<sup>1</sup>  
A new ship  
An existing ship

Type of ship<sup>1</sup>  
Type 'A'  
Type 'B'  
Type 'B' with reduced freeboard  
Type 'B' with increased freeboard

**Freeboard from Deck Line<sup>2</sup>**

Tropical \_\_\_\_\_ mm (T)  
Summer \_\_\_\_\_ mm (S)  
Winter \_\_\_\_\_ mm (W)  
Winter North Atlantic \_\_\_\_\_ mm (WNA)  
Timber tropical \_\_\_\_\_ mm (LT)  
Timber summer \_\_\_\_\_ mm (LS)  
Timber winter \_\_\_\_\_ mm (LW)  
Timber winter North Atlantic \_\_\_\_\_ mm (LWNA)

**Load Line<sup>2</sup>**

\_\_\_\_\_ mm above (S)  
Upper edge of line through centre of ring  
\_\_\_\_\_ mm below (S)  
\_\_\_\_\_ mm below (S)  
\_\_\_\_\_ mm above (LS)  
\_\_\_\_\_ mm above (S)  
\_\_\_\_\_ mm below (LS)  
\_\_\_\_\_ mm below (LS)

Allowance for fresh water for all freeboards other than timber \_\_\_\_\_ mm. For timber freeboards \_\_\_\_\_ mm.  
The upper edge of the deck line from which these freeboards are measured is \_\_\_\_\_ mm \_\_\_\_\_ deck at side.

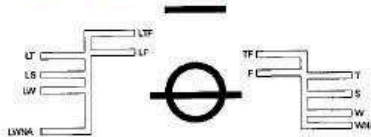

THIS IS TO CERTIFY:

- That the ship has been surveyed in accordance with the requirements of article 14 of the Convention.
- That the survey showed that the freeboards have been assigned and load lines shown above have been marked in accordance with the Convention.

This certificate is valid until \_\_\_\_\_<sup>3</sup> subject to annual surveys in accordance with article 14 (1) (c) of the Convention.

Completion date of the survey on which this certificate is based: \_\_\_\_\_ (dd/mm/yyyy).

Issued at \_\_\_\_\_ on \_\_\_\_\_  
(Place of issue) (Date of issue)

\_\_\_\_\_  
(Signature of authorised official issuing the certificate)

(Seal or stamp of the authority, as appropriate)

- Notes 1. When a ship departs from a port situated on a river or inland waters, deeper loading shall be permitted corresponding to the weight of fuel and all other materials required for consumption between the point of departure and the sea.
2. When a ship is in fresh water of unit density the appropriate load line may be submerged by the amount of the fresh water allowance shown above. Where the density is other than unity, an allowance shall be made proportional to the difference between 1.025 and the actual density.

<sup>1</sup> Delete as appropriate.

<sup>2</sup> Freeboard and load lines which are not applicable need not be entered on the certificate. Subdivision load lines may be entered on the certificate on a voluntary basis.

<sup>3</sup> Insert the date of expiry as specified by the Director or Recognized Organization in accordance with article 19 (1) of the Convention. The day and month of this date correspond to the anniversary date as defined in article 2 (9) of the Convention unless amended in accordance with article 19 (8) of the Convention.

[S 690/2006 wef 01/01/2007]

Endorsement for Annual Surveys

THIS IS TO CERTIFY that, at an annual survey required by article 14 (1) (c) of the Convention, the ship was found to comply with the relevant requirements of the Convention.

Annual range date of survey: .....

Annual survey: Signed: .....  
(Signature of authorised official)

Place: .....

Date: .....

(Seal or stamp of the authority, as appropriate)

Annual survey: Signed: .....  
(Signature of authorised official)

Place: .....

Date: .....

(Seal or stamp of the authority, as appropriate)

Annual survey: Signed: .....  
(Signature of authorised official)

Place: .....

Date: .....

(Seal or stamp of the authority, as appropriate)

Annual survey: Signed: .....  
(Signature of authorised official)

Place: .....

Date: .....

(Seal or stamp of the authority, as appropriate)



**Annual survey in accordance with article 19 (8) (c)**

THIS IS TO CERTIFY that, at a survey in accordance with article 19 (8) (c) of the Convention, the ship was found to comply with the relevant requirements of the Convention.

Signed: .....  
(Signature of authorised official)

Place: .....

Date: .....

*(Seal or stamp of the authority, as appropriate)*

**Endorsement to extend the certificate if valid for less than 5 years where article 19 (3) applies**

The ship complies with the relevant requirements of the Convention, and this certificate shall, in accordance with article 19 (3) of the Convention, be accepted as valid until .....

Signed: .....  
(Signature of authorised official)

Place: .....

Date: .....

*(Seal or stamp of the authority, as appropriate)*

**Endorsement where the renewal survey has been completed and article 19 (4) applies**

The ship complies with the relevant requirements of the Convention, and this certificate shall, in accordance with article 19 (4) of the Convention, be accepted as valid until .....

Signed: .....  
(Signature of authorised official)

Place: .....

Date: .....

*(Seal or stamp of the authority, as appropriate)*

**Endorsement to extend the validity of the certificate until reaching the port of survey or for a period of grace where article 19 (5) or 19 (6) applies**

This certificate shall, in accordance with article 19 (5)/19 (6)<sup>4</sup> of the Convention, be accepted as valid until .....

Signed: .....  
(Signature of authorised official)

Place: .....

Date: .....

*(Seal or stamp of the authority, as appropriate)*

**Endorsement for advancement of anniversary date where article 19 (8) applies**

In accordance with article 19 (8) of the Convention, the new anniversary date is .....

Signed: .....  
(Signature of authorised official)

Place: .....

Date: .....

*(Seal or stamp of the authority, as appropriate)*

In accordance with article 19 (8) of the Convention, the new anniversary date is .....

Signed: .....  
(Signature of authorised official)

Place: .....

Date: .....

*(Seal or stamp of the authority, as appropriate)*

<sup>4</sup>Delete as appropriate.

[S 12/2005 wef 06/01/2005]

MERCHANT SHIPPING ACT  
(CHAPTER 179)

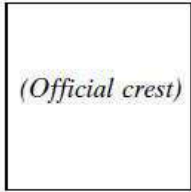

SINGAPORE LOAD LINE CERTIFICATE

REPUBLIC OF SINGAPORE

Issued under the provisions of the  
MERCHANT SHIPPING (LOAD LINE) REGULATIONS,  
under the authority of the Government of the Republic of Singapore  
by

(person or organization authorised)

Particulars of ship

Name of Ship	Official Number	Port of Registry	Length (L) as defined in regulation 2 (in metres)

IMO Number: \_\_\_\_\_

Freeboard assigned as:<sup>1</sup>

- A new ship
- An existing ship

Type of ship<sup>1</sup>

- Type 'A'
- Type 'B'
- Type 'B' with reduced freeboard
- Type 'B' with increased freeboard

Freeboard from Deck Line<sup>2</sup>

- Tropical \_\_\_\_\_ mm (T)
- Summer \_\_\_\_\_ mm (S)
- Winter \_\_\_\_\_ mm (W)
- Winter North Atlantic \_\_\_\_\_ mm (WNA)
- Timber tropical \_\_\_\_\_ mm (LT)
- Timber summer \_\_\_\_\_ mm (LS)
- Timber winter \_\_\_\_\_ mm (LW)
- Timber winter North Atlantic \_\_\_\_\_ mm (LWNA)

Load Line<sup>2</sup>

- \_\_\_\_\_ mm above (S)
- Upper edge of line through centre of ring
- \_\_\_\_\_ mm below (S)
- \_\_\_\_\_ mm below (S)
- \_\_\_\_\_ mm above (LS)
- \_\_\_\_\_ mm above (S)
- \_\_\_\_\_ mm below (LS)
- \_\_\_\_\_ mm below (LS)

Allowance for fresh water for all freeboards other than timber \_\_\_\_\_ mm. For timber freeboards \_\_\_\_\_ mm.  
The upper edge of the deck line from which these freeboards are measured is \_\_\_\_\_ mm \_\_\_\_\_ deck at side.

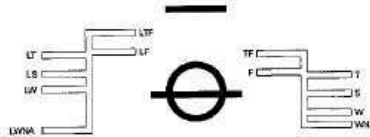

THIS IS TO CERTIFY:

- (1) That the ship has been surveyed in accordance with the requirements of regulation 14 of the Regulations.
- (2) That the survey showed that the freeboards have been assigned and load lines shown above have been marked in accordance with the Regulations.

This certificate is valid until \_\_\_\_\_<sup>3</sup> subject to annual surveys in accordance with regulation 14 (1) (c) of the Regulations.  
Completion date of the survey on which this certificate is based: \_\_\_\_\_ (dd/mm/yyyy).

Issued at \_\_\_\_\_ on \_\_\_\_\_  
(Place of issue) (Date of issue)

\_\_\_\_\_  
(Signature of authorised official issuing the certificate)

(Seal or stamp of the authority, as appropriate)

- Notes
1. When a ship departs from a port situated on a river or inland waters, deeper loading shall be permitted corresponding to the weight of fuel and all other materials required for consumption between the point of departure and the sea.
  2. When a ship is in fresh water of unit density the appropriate load line may be submerged by the amount of the fresh water allowance shown above. Where the density is other than unity, an allowance shall be made proportional to the difference between 1.025 and the actual density.

<sup>1</sup> Delete as appropriate.

<sup>2</sup> Freeboard and load lines which are not applicable need not be entered on the certificate. Subdivision load lines may be entered on the certificate on a voluntary basis.

<sup>3</sup> Insert the date of expiry as specified by the Director or Recognized Organization in accordance with article 19 (1) of the Regulations. The day and month of this date correspond to the anniversary date as defined in regulation 2 of the Regulations unless amended in accordance with article 19 (16) of the Regulations.

[S 690/2006 wef 01/01/2007]

**Endorsement for Annual Surveys**

THIS IS TO CERTIFY that, at an annual survey required by regulation 14 (1) (c) of the Regulations, the ship was found to comply with the relevant requirements of the Regulations.

Annual range date of survey: .....

Annual survey: Signed: .....  
(Signature of authorised official)

Place: .....

Date: .....

(Seal or stamp of the authority, as appropriate)

Annual survey: Signed: .....  
(Signature of authorised official)

Place: .....

Date: .....

(Seal or stamp of the authority, as appropriate)

Annual survey: Signed: .....  
(Signature of authorised official)

Place: .....

Date: .....

(Seal or stamp of the authority, as appropriate)

Annual survey: Signed: .....  
(Signature of authorised official)

Place: .....

Date: .....

(Seal or stamp of the authority, as appropriate)

**Annual survey in accordance with regulation 19 (16) (c)**

THIS IS TO CERTIFY that, at a survey in accordance with regulation 19 (16) (c) of the Regulations, the ship was found to comply with the relevant requirements of the Regulations.

Signed: .....  
*(Signature of authorised official)*

Place: .....

Date: .....

*(Seal or stamp of the authority, as appropriate)*

**Endorsement to extend the certificate if valid for less than 5 years where regulation 19 (5) applies**

The ship complies with the relevant requirements of the Regulations, and this certificate shall, in accordance with regulation 19 (5) of the Regulations, be accepted as valid until .....

Signed: .....  
*(Signature of authorised official)*

Place: .....

Date: .....

*(Seal or stamp of the authority, as appropriate)*

**Endorsement where the renewal survey has been completed and regulation 19 (6) and (7) applies**

The ship complies with the relevant requirements of the Regulations, and this certificate shall, in accordance with regulation 19 (6) and (7) of the Regulations, be accepted as valid until .....

Signed: .....  
*(Signature of authorised official)*

Place: .....

Date: .....

*(Seal or stamp of the authority, as appropriate)*

**Endorsement to extend the validity of the certificate until reaching the port of survey or for a period of grace where regulation 19 (8), (9), (10), (11), (12) or (13) applies**

This certificate shall, in accordance with regulation 19 (8)/19 (9)/19 (10)/19 (11)/19 (12)/19 (13)<sup>4</sup> of the Regulations, be accepted as valid until .....

Signed: .....  
(Signature of authorised official)

Place: .....

Date: .....

*(Seal or stamp of the authority, as appropriate)*

**Endorsement for advancement of anniversary date where regulation 19 (16) applies**

In accordance with regulation 19 (16) of the Regulations, the new anniversary date is .....

Signed: .....  
(Signature of authorised official)

Place: .....

Date: .....

*(Seal or stamp of the authority, as appropriate)*

In accordance with regulation 19 (16) of the Regulations, the new anniversary date is .....

Signed: .....  
(Signature of authorised official)

Place: .....

Date: .....

*(Seal or stamp of the authority, as appropriate)*

<sup>4</sup>Delete as appropriate.

[S 12/2005 wef 06/01/2005]

MERCHANT SHIPPING ACT  
(CHAPTER 179)

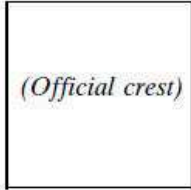

INTERNATIONAL LOAD LINE EXEMPTION CERTIFICATE

REPUBLIC OF SINGAPORE

Issued under the provisions of the  
INTERNATIONAL CONVENTION ON LOAD LINES, 1966,  
as modified by the Protocol of 1988 relating thereto  
under the authority of the Government of the Republic of Singapore  
by

(person or organization authorised)

Particulars of ship

Name of Ship	Official Number	Port of Registry	Length (L) as defined in article 2 (8) (in metres)

IMO Number: \_\_\_\_\_

THIS IS TO CERTIFY:

That the ship is exempted from the provisions of the Convention, under the authority conferred by article 6 (2)/6 (4)<sup>1</sup> of the Convention referred to above.

The provisions of the Convention from the ship is exempted under article 6 (2) are:

.....  
.....  
.....

The voyage for which exemption is granted under article 6 (4) is:

From: .....

To: .....

Conditions, if any, on which the exemption is granted under either article 6 (2) or article 6 (4):

.....  
.....  
.....

This certificate is valid until .....<sup>2</sup> subject to annual surveys in accordance with article 14 (1) (c) of the Convention.

Completion date of the survey on which this certificate is based: \_\_\_\_\_ (dd/mm/yyyy).

Issued at \_\_\_\_\_ on \_\_\_\_\_  
(Place of issue) (Date of issue) (Signature of authorised official issuing the certificate)

(Seal or stamp of the authority, as appropriate)

<sup>1</sup> Delete as appropriate.

<sup>2</sup> Insert the date of expiry as specified by the Director or Recognized Organization in accordance with article 19 (10) of the Convention. The day and the month of this date correspond to the anniversary date as defined in article 2 (9) of the Convention unless amended in accordance with article 19 (8) of the Convention.

[S 690/2006 wef 01/01/2007]

**Endorsement for Annual Surveys**

THIS IS TO CERTIFY that, at an annual survey required by article 14 (1) (c) of the Convention, the ship was found to comply with the conditions under which this exemption was granted.

Annual range date of survey: .....

Annual survey: Signed: .....  
(Signature of authorised official)

Place: .....

Date: .....

(Seal or stamp of the authority, as appropriate)

Annual survey: Signed: .....  
(Signature of authorised official)

Place: .....

Date: .....

(Seal or stamp of the authority, as appropriate)

Annual survey: Signed: .....  
(Signature of authorised official)

Place: .....

Date: .....

(Seal or stamp of the authority, as appropriate)

Annual survey: Signed: .....  
(Signature of authorised official)

Place: .....

Date: .....

(Seal or stamp of the authority, as appropriate)



**Annual survey in accordance with article 19 (8) (c)**

THIS IS TO CERTIFY that, at a survey in accordance with article 19 (8) (c) of the Convention, this ship was found to comply with the relevant requirements of the Convention.

Signed: .....  
(Signature of authorised official)

Place: .....

Date: .....

*(Seal or stamp of the authority, as appropriate)*

**Endorsement to extend the certificate if valid for less than 5 years where article 19 (3) applies**

The ship complies with the relevant requirements of the Convention, and this certificate shall, in accordance with article 19 (3) of the Convention, be accepted as valid until .....

Signed: .....  
(Signature of authorised official)

Place: .....

Date: .....

*(Seal or stamp of the authority, as appropriate)*

**Endorsement where the renewal survey has been completed and article 19 (4) applies**

The ship complies with the relevant requirements of the Convention, and this certificate shall, in accordance with article 19 (4) of the Convention, be accepted as valid until .....

Signed: .....  
(Signature of authorised official)

Place: .....

Date: .....

*(Seal or stamp of the authority, as appropriate)*

**Endorsement to extend the validity of the certificate until reaching the port of survey or for a period of grace where article 19 (5) or 19 (6) applies**

This certificate shall, in accordance with article 19 (5)/19 (6)<sup>3</sup> of the Convention, be accepted as valid until .....

Signed: .....  
(Signature of authorised official)

Place: .....

Date: .....

*(Seal or stamp of the authority, as appropriate)*

**Endorsement for advancement of anniversary date where article 19 (8) applies**

In accordance with article 19 (8) of the Convention, the new anniversary date is .....

Signed: .....  
(Signature of authorised official)

Place: .....

Date: .....

*(Seal or stamp of the authority, as appropriate)*

In accordance with article 19 (8) of the Convention, the new anniversary date is .....

Signed: .....  
(Signature of authorised official)

Place: .....

Date: .....

*(Seal or stamp of the authority, as appropriate)*

<sup>3</sup>Delete as appropriate.

[S 12/2005 wef 06/01/2005]

MERCHANT SHIPPING ACT  
(CHAPTER 179)

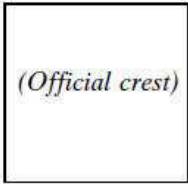

SINGAPORE LOAD LINE EXEMPTION CERTIFICATE

REPUBLIC OF SINGAPORE

Issued under the provisions of the  
MERCHANT SHIPPING (LOAD LINE) REGULATIONS,  
by

(person or organization authorised)

Particulars of ship

Table with 4 columns: Name of Ship, Official Number, Port of Registry, Length (L) as defined in regulation 2 (in metres)

IMO Number: \_\_\_\_\_

THIS IS TO CERTIFY:

That the ship is exempted from the provisions of the Regulations, under the authority conferred by regulation 6 (2)/6 (4)<sup>1</sup> of the Regulations referred to above.

The provisions of the Regulations from the ship is exempted under regulation 6 (2) are:

.....  
.....  
.....

The voyage for which exemption is granted under regulation 6 (4) is:

From: .....

To: .....

Conditions, if any, on which the exemption is granted under either regulation 6 (2) or 6 (4):

.....  
.....  
.....

This certificate is valid until .....<sup>2</sup> subject to annual surveys in accordance with regulation 14 (1) (c) of the Regulations.

Completion date of the survey on which this certificate is based: \_\_\_\_\_ (dd/mm/yyyy).

Issued at \_\_\_\_\_ on \_\_\_\_\_  
(Place of issue) (Date of issue) (Signature of authorised official issuing the certificate)

(Seal or stamp of the authority, as appropriate)

<sup>1</sup> Delete as appropriate.

<sup>2</sup> Insert the date of expiry as specified by the Director or Recognized Organization in accordance with regulation 19 (18) of the Regulations. The day and the month of this date correspond to the anniversary date as defined in regulation 2 of the Regulations unless amended in accordance with article 19 (16) of the Regulations.

[S 690/2006 wef 01/01/2007]

Endorsement for Annual Surveys

THIS IS TO CERTIFY that, at an annual survey required by regulation 14 (1) (c) of the Regulations, the ship was found to comply with the conditions under which this exemption was granted.

Annual range date of survey: .....

Annual survey: Signed: .....  
(Signature of authorised official)

Place: .....

Date: .....

(Seal or stamp of the authority, as appropriate)

Annual survey: Signed: .....  
(Signature of authorised official)

Place: .....

Date: .....

(Seal or stamp of the authority, as appropriate)

Annual survey: Signed: .....  
(Signature of authorised official)

Place: .....

Date: .....

(Seal or stamp of the authority, as appropriate)

Annual survey: Signed: .....  
(Signature of authorised official)

Place: .....

Date: .....

(Seal or stamp of the authority, as appropriate)

**Annual survey in accordance with regulation 19 (16) (c)**

THIS IS TO CERTIFY that, at a survey in accordance with regulation 19 (16) (c) of the Regulations, this ship was found to comply with the relevant requirements of the Regulations.

Signed: .....  
(Signature of authorised official)

Place: .....

Date: .....

*(Seal or stamp of the authority, as appropriate)*

**Endorsement to extend the certificate if valid for less than 5 years where regulation 19 (5) applies**

The ship complies with the relevant requirements of the Regulations, and this certificate shall, in accordance with regulation 19 (5) of the Regulations, be accepted as valid until .....

Signed: .....  
(Signature of authorised official)

Place: .....

Date: .....

*(Seal or stamp of the authority, as appropriate)*

**Endorsement where the renewal survey has been completed and regulation 19 (6) and (7) applies**

The ship complies with the relevant requirements of the Regulations, and this certificate shall, in accordance with regulation 19 (6) and (7) of the Regulations, be accepted as valid until .....

Signed: .....  
(Signature of authorised official)

Place: .....

Date: .....

*(Seal or stamp of the authority, as appropriate)*

**Endorsement to extend the validity of the certificate until reaching the port of survey or for a period of grace where regulation 19 (8), (9), (10), (11), (12) or (13) applies**

This certificate shall, in accordance with regulation 19 (8)/19 (9)/19 (10)/19 (11)/19 (12)/19 (13)<sup>3</sup> of the Regulations, be accepted as valid until .....

Signed: .....  
(Signature of authorised official)

Place: .....

Date: .....

*(Seal or stamp of the authority, as appropriate)*

**Endorsement for advancement of anniversary date where regulation 19 (16) applies**

In accordance with regulation 19 (8) of the Regulations, the new anniversary date is .....

Signed: .....  
(Signature of authorised official)

Place: .....

Date: .....

*(Seal or stamp of the authority, as appropriate)*

In accordance with regulation 19 (16) of the Regulations, the new anniversary date is .....

Signed: .....  
(Signature of authorised official)

Place: .....

Date: .....

*(Seal or stamp of the authority, as appropriate)*

<sup>3</sup>Delete as appropriate.

[S 12/2005 wef 06/01/2005]

[G.N. No. S 39/2000]

LEGISLATIVE HISTORY  
MERCHANT SHIPPING (LOAD LINE) REGULATIONS  
(CHAPTER 179, RG 5)

This Legislative History is provided for the convenience of users of the Merchant Shipping (Load Line) Regulations. It is not part of these Regulations.

**1. G. N. No. S 39/2000 — Merchant Shipping (Load Line) Regulations 2000**

Date of commencement : 3 February 2000

**2. 2001 Revised Edition — Merchant Shipping (Load Line) Regulations**

Date of operation : 31 January 2001

**3. G. N. No. S 12/2005 — Merchant Shipping (Load Line) (Amendment) Regulations 2005**

Date of commencement : 6 January 2005

**4. G. N. No. S 690/2006 — Merchant Shipping (Load Line) (Amendment) Regulations 2006**

Date of commencement : 1 January 2007

**5. G. N. No. S 403/2008 — Merchant Shipping (Load Line) (Amendment) Regulations 2008**

Date of commencement : 15 August 2008

**6. G. N. No. S 330/2010 — Merchant Shipping (Load Line) (Amendment) Regulations 2010**

Date of commencement : 1 July 2010

**7. G.N. No. S 834/2013 — Merchant Shipping (Load Line) (Amendment) Regulations 2013**

Date of commencement : 1 January 2014

**8. G.N. No. S 430/2014 — Merchant Shipping (Load Line) (Amendment) Regulations 2014**

Date of commencement : 1 July 2014

**9. G.N. No. S 865/2014 — Merchant Shipping (Load Line) (Amendment No. 2) Regulations 2014**

Date of commencement : 1 January 2015

**10. G.N. No. S 796/2015 — Merchant Shipping (Load Line) (Amendment) Regulations 2015**

Date of commencement : 1 January 2016

**11. G.N. No. S 893/2023 — Merchant Shipping (Load Line) (Amendment)  
Regulations 2023**

Date of commencement : 1 January 2024