

ROAD TRAFFIC ACT
(CHAPTER 276, SECTIONS 119 AND 140)

ROAD TRAFFIC (TRAFFIC SIGNS) RULES

ARRANGEMENT OF RULES

Rule

1. Citation
 2. Prescribed traffic signs
 3. Types of traffic signs
 4. Inscriptions on signs
 5. Change of directions
 6. Parking places
 7. Lines, markings or traffic devices on roads
 8. Bus lanes
 - 8A. Bicycle Lane
 9. Road divider
 10. Light signals for vehicles
 11. The 3-colour system
 12. The 2-colour system
 13. Light signals for lanes
 14. Miniature light signals
 15. Light signals for pedestrians
 16. Light signals for bicycles
 17. Temporary beacons
 18. Temporary signs for road works
- The Schedule
-

[1st November 1991]

Citation

1. These Rules may be cited as the Road Traffic (Traffic Signs) Rules.

Prescribed traffic signs

2.—(1) Subject to any directions which the Minister may give under section 119 of the Act, the traffic signs authorised to be drawn or placed on or near any road shall —

(a) be at least of the size, and conform to the colour and type as prescribed in the diagrams set out in the Schedule; and

(b) conform to the descriptions set out in these Rules.

(2) The dimension of the traffic signs as given in the diagrams set out in the Schedule denotes the dimension in millimetres unless otherwise stated.

(3) A traffic sign drawn or placed on or near a road shall be deemed to be a prescribed traffic sign and to have been so lawfully drawn or placed unless the contrary is proved.

(4) The fact that a traffic sign differs slightly in size, colour or type from that prescribed in these Rules shall not prevent the traffic sign from being a regular or lawful sign so long as the sign is not thereby misleading or its general appearance materially altered or its effectiveness impaired.

Types of traffic signs

3. The traffic signs set out in the Schedule are divided as follows:

(a) regulatory signs as set out in Part I of the Schedule which are intended to inform road users of special obligations, restrictions and prohibitions with which they must comply and are subdivided into —

(i) mandatory signs;

(ii) priority signs; and

(iii) prohibitory or restrictive signs;

(b) warning signs as set out in Part II of the Schedule which are intended to warn road users of the danger on the road and to inform them of the nature and source of the danger; and

(c) informative signs as set out in Part III of the Schedule which are intended to provide road users with information which may be useful while they are travelling.

Inscriptions on signs

4. The inscription on the traffic signs shall be in the English language except that there may also be inscription in another language or languages on the signs.

Change of directions

5. The direction of any arrow or other indication on the signs shown in the diagrams in the Schedule may be reversed or otherwise varied as circumstances may require.

Parking places

6. The signs shown in diagrams 36(a) to 36(f) in Part I of the Schedule shall be used only in connection with parking places owned by or under the control of the Government or statutory bodies.

Lines, markings or traffic devices on roads

7.—(1) Lines, markings and other traffic devices may be drawn or placed on a road to indicate —

- (a) the position where vehicles shall stop or reduce speed when required to do so by a traffic sign, or a police officer engaged in the control of traffic;
- (b) the course and direction to be followed by traffic;
- (c) a street refuge;
- (d) places reserved for bus terminals, bus stops, taxi stands, taxi stops, trishaw stands, motor cycle parks, bicycle parks, car parks, coach parks, lorry parks, trailer parks, loading and unloading bays and vehicles of handicapped persons;
- (e) a pedestrian crossing;
- (f) a bicycle crossing;
- (g) the edge of the road;
- (h) a central reservation which divides the road for the safety or guidance of traffic;
- (i) a yellow box;

(j) a road shoulder along an expressway;

(ja) a bicycle lane;

[S 172/2017 wef 22/04/2017]

(k) a part-day bus lane;

[S 639/2005 wef 03/10/2005]

(ka) a full-day bus lane;

[S 639/2005 wef 03/10/2005]

(l) the section of the road where parking of vehicles is restricted or prohibited;

(m) the boundary on the road which no vehicle, whether overtaking other vehicles or not, shall cross;

[S 651/2008 wef 20/12/2008]

(n) a parking place or a public service vehicle stand;

[S 651/2008 wef 20/12/2008]

(o) a Bus Give-Way Controlled Area;

[S 651/2008 wef 20/12/2008]

(p) a Bus Give-Way Line; and

[S 651/2008 wef 20/12/2008]

(q) a Bus Give-Way Box.

[S 651/2008 wef 20/12/2008]

(2) The lines, markings and other traffic devices drawn or placed on a road shall be painted or indicated by other suitable material in white, yellow or red.

(3) The width of longitudinal lines on a road shall not be less than 100 mm and the width of transverse lines on a road shall not be less than 200 mm.

(4) A zebra pedestrian crossing is indicated by markings across a road as shown in diagram 142(a), 142(b), 143(a), 143(b), 144(a) or 144(b) in Part III of the Schedule and such crossing may, in addition, also be identified on either side of the road by a pair of —

(a) traffic signs facing approaching vehicles as set out in diagram 125(a) in Part III of the Schedule; or

(b) amber beacons of not less than 300 mm in diameter which may be intermittently or otherwise internally illuminated.

(5) A signalised pedestrian crossing is indicated by 2 parallel, continuous or broken white lines each of not less than 200 mm in width and spaced not less than 3,000 mm apart from centre to centre from one edge of the road to the other as shown in diagrams 140(a) and 145 in Part III of the Schedule.

[S 572/2005 wef 01/09/2005]

(6) A pedestrian crossing (other than a signalised pedestrian crossing) at a signal-controlled junction is indicated by 2 parallel yellow lines each of not less than 300 mm in width and spaced not less than 3,000 mm apart from the centre to centre from one edge of the road to the other as shown in diagram 140(e) in Part III of the Schedule.

(7) A signalised bicycle crossing is indicated by 2 parallel white lines each of not less than 300 mm in width and spaced not less than 3,000 mm apart from the centre of one line to the other and with the 2 lines running from one edge of the road, subway or bridge, as the case may be, to the other as shown in diagram 145(a) in Part III of the Schedule.

(8) A yellow box is indicated by yellow lines connecting the 4 corners of an area of road at a road junction or on any part of the road as shown in diagrams 140(a) to 140(d) in Part III of the Schedule.

(9) A road shoulder is the strip constructed with a surface suitable for motor vehicles to move along or stop, along the left (nearside) or right (offside) of a road and is demarcated from the road by a continuous white marginal line of not less than 300 mm in width as shown in diagram 151(e) in Part III of the Schedule.

(10) The edge of a road is indicated by a continuous or broken white marginal line of not less than 300 mm in width as shown in diagrams 139(b) and 139(c) in Part III of the Schedule.

(11) A part-day bus lane is the section of a road marked by a longitudinal continuous yellow line of not less than 300 mm in width and transverse yellow lines of not less than 200 mm in width and

1,200 mm in length as shown in diagrams 115(a) to 115(d) in Part III of the Schedule.

[S 639/2005 wef 03/10/2005]

(11A) A full-day bus lane is the section of a road marked by —

- (a) a longitudinal continuous yellow line of not less than 300 mm in width parallel to a longitudinal continuous red line of not less than 150 mm in width; and
- (b) transverse yellow lines of not less than 200 mm in width and 1,200 mm in length,

as shown in diagrams 115(e) to 115(h) in Part III of the Schedule.

[S 639/2005 wef 03/10/2005]

(11B) A bicycle lane is the section of a road, marked by —

- (a) a longitudinal, continuous chevron marking; and
- (b) a bicycle symbol that appears at regular intervals on that section of the road.

[S 172/2017 wef 22/04/2017]

(11C) The markings mentioned in paragraph (11B) are shown in diagram 166 in Part III of the Schedule.

[S 172/2017 wef 22/04/2017]

(12) The boundary which no vehicle shall cross under paragraph (1)(m) is indicated by continuous double white lines as shown in diagram 150(a) in Part III of the Schedule.

(13) A parking place or a public service vehicle stand is indicated by broken or continuous lines as shown in diagram 156 in Part III of the Schedule.

(14) A Bus Give-Way Controlled Area is the section of a road marked by white triangle markings and the word “Bus” in white as shown in diagram 116(d) in Part III of the Schedule.

[S 651/2008 wef 20/12/2008]

(15) A Bus Give-Way Box is the section of a road painted in yellow and marked by an arrow, which —

- (a) appears after a Bus Give-Way Controlled Area; and

(b) is separated from the Bus Give-Way Controlled Area by a Bus Give-Way Line,

as shown in diagram 116(d) in Part III of the Schedule.

[S 651/2008 wef 20/12/2008]

Bus lanes

8.—(1) Except on any Saturday, Sunday or public holiday, no person shall drive a vehicle other than an omnibus, or cause or permit any such vehicle to remain, on a part-day bus lane during the hours of 7.30 a.m. to 9.30 a.m. and 5 p.m. to 8 p.m.

[S 134/2007 wef 01/04/2007]

(1A) Except on any Sunday or public holiday, no person shall drive a vehicle other than an omnibus, or cause or permit any such vehicle to remain, on a full-day bus lane during the hours of 7.30 a.m. to 11 p.m.

[S 134/2007 wef 01/04/2007]

[S 114/2016 wef 21/03/2016]

(2) Paragraphs (1) and (1A) shall not apply to —

- (a) the driver of an ambulance, fire engine or any vehicle for police or rescue purposes on urgent duty call if the approach of such vehicle is made known by means of some distinctive siren, bell or multi-toned horn, as the case may be;
- (b) a cyclist who is not cycling alongside of another bicycle on his left;
- (c) the driver of a motor vehicle who drives along the bus lane in order to avoid causing danger to any person or a collision with any other vehicle if that driver does not cause or permit the vehicle to remain on the bus lane longer than is necessary to avoid causing such danger or collision;

[S 549/2001 wef 01/11/2001]

- (d) the driver of a school bus, a private hire bus or an excursion bus when it is used to carry passengers for reward under a Supplementary Public Transport Scheme in accordance with —

- (i) a public service vehicle licence that is issued for that bus under section 102 of the Act; and
- (ii) a bus service licence that is granted or is deemed granted under section 13 of the Bus Services Industry Act 2015 (Act 30 of 2015); and

[S 676/2016 wef 01/01/2017]

- (e) the driver of any other bus except that he shall not stop the bus in a bus lane or at a bus stand or bus bay within a bus lane for any purpose other than for the purpose of negotiating traffic.

[S 549/2001 wef 01/11/2001]

[S 114/2016 wef 21/03/2016]

- (3) In this rule, “bus lane” means any full-day or part-day bus lane.

[S 639/2005 wef 03/10/2005]

Bicycle Lane

- 8A.** A person must not park a vehicle on a bicycle lane at any time.

[S 172/2017 wef 22/04/2017]

Road divider

- 9.** No vehicle shall pass over a road divider.

Light signals for vehicles

- 10.** Vehicular traffic may be regulated by the following light signals:

- (a) a 3-colour system;
- (b) a 2-colour system;
- (c) lane use light signals; and
- (d) restricted zone light signals.

The 3-colour system

- 11.** In a 3-colour system —

- (a) the signals shall consist of 3 lights, which shall be red, amber and green respectively, except that there may be —

- (i) any red, amber or green arrow light;
 - (ii) any combination of red, amber or green arrow lights;
or
 - (iii) such other additional green light or lights as may be provided for in this rule for special purposes;
- (b) the signals shall consist of 3 arrows (either in left, right or straight ahead direction), which shall be red, amber and green respectively, except that there may be —
- (i) any red, amber or green arrow light;
 - (ii) any combination of red, amber or green arrow lights;
or
 - (iii) such other additional green light or lights as may be provided for in this rule for special purposes;
- (c) the red, amber and green lights shall be arranged vertically or horizontally facing the direction of approaching traffic and —
- (i) where they are arranged vertically, the red light shall be placed above the amber light and the green light shall be placed below the amber light;
 - (ii) where they are arranged horizontally, the red light shall be placed on the right of the amber light and the green light shall be placed on the left of the amber light;
 - (iii) where they are arranged vertically with any combination of red, amber or green arrow lights, each arrow light shall be placed at the same level with a light of the same colour; and
 - (iv) where they are arranged horizontally with any combination of red, amber or green arrow lights, each arrow light shall be placed below the light of the same colour;
- (d) any additional arrow light referred to in paragraph (a)(i) shall be placed —

- (i) at the same level of the light of the same colour where the lights are arranged vertically;
 - (ii) above the red light where the lights are arranged vertically; or
 - (iii) below the light of the same colour where the lights are arranged horizontally;
- (e) any additional green light referred to in paragraph (a)(iii) shall be placed at the same level on the left side of or above the red light facing the direction of the approaching traffic where the lights are arranged vertically;
- (f) the red, amber and green arrow lights of the same direction shall be arranged vertically or horizontally facing the direction of approaching traffic and —
- (i) where they are arranged vertically, the red arrow light shall be placed above the amber arrow light and the green arrow light shall be placed below the amber arrow light;
 - (ii) where they are arranged horizontally, the red arrow light shall be placed on the right of the amber arrow light and the green arrow light shall be placed on the left of the amber arrow light;
 - (iii) where they are arranged vertically with any combination of red, amber and green arrow lights of different directions, they shall be placed at the same level of the arrow lights of the same colour; and
 - (iv) where they are arranged horizontally with any combination of red, amber and green arrow lights of different directions, they shall be placed below the arrow light of the same colour;
- (g) any additional arrow light referred to in paragraph (b) (i) shall be placed —
- (i) at the same level of the arrow light of the same colour where the arrow lights are arranged vertically;

- (ii) above the red arrow light where the arrow lights are arranged vertically; and
- (iii) below the arrow light of the same colour where the arrow lights are arranged horizontally;
- (h) any additional green light referred to in paragraph (b) (iii) shall be placed at the same level on the left side of or above the red arrow light facing the direction of the approaching traffic where the lights are arranged vertically;
- (i) where the lights and arrow lights are arranged vertically —
 - (i) the effective diameter of the lens of each light and arrow light shall be at least 200 mm;
 - (ii) the height of the centre of the lens of the light or arrow light nearest to the ground surface shall be 2,290 mm except that it may be increased to 3,000 mm where owing to road gradient it is desirable to do so; and
 - (iii) the centres of the lenses of the 2 lights, 2 arrow lights or any combination thereof placed next to each other shall not be more than 500 mm apart;
- (j) where the lights and arrow lights are arranged horizontally —
 - (i) the effective diameter of the lens of each light and arrow light shall be at least 300 mm;
 - (ii) the height of the centre of the lens of the light or arrow light nearest to the ground surface shall not be less than 5,200 mm; and
 - (iii) the centres of the lenses of the 2 lights, 2 arrow lights or any combination thereof placed next to each other shall not be more than 500 mm apart; and
- (k) subject to the directions of any police officer who may be engaged in the control of traffic —
 - (i) the illuminated red light shall be taken as prohibiting vehicles from proceeding beyond the stop line or

broken lines on the road provided in conjunction with the signals, subject to sub-paragraphs (v), (ix), (x) and (xi);

- (ii) the illuminated amber light shall be taken to denote an impending change from green light to red light and as prohibiting vehicles from proceeding beyond the stop line or broken lines on the road provided in conjunction with the signals except in the case of any vehicle which is so close to such line when the amber light first appears that it cannot safely be stopped before the line;
- (iii) the illuminated green light shall be taken to indicate that vehicles may pass the signal and proceed straight on, or with due regard to the safety of other users of the road and precedence to pedestrians and on-coming traffic, turn left or right subject to any sign prohibiting left or right turn or in conjunction with the arrow light signals, subject to sub-paragraphs (x) and (xi);
- (iv) where the green light shows one or more illuminated arrow or arrows, it shall be taken to indicate that vehicles may only proceed in the direction or directions indicated by the arrow or arrows (where the arrow points upwards, vehicles may only proceed straight ahead);
- (v) where the signals consist of one or more additional green arrow light or lights —
 - (A) the illuminated green arrow light or lights shall be taken to indicate that vehicles, notwithstanding that they would otherwise be required by the illuminated red or amber light to stop, may proceed in the direction or directions indicated by the green arrow or arrows with precedence to pedestrians; and
 - (B) the illuminated intermittent green arrow flashing light shall be taken as prohibiting

vehicles from proceeding beyond the stop line on the road provided in conjunction with the signals except in the case of any vehicle which is so close to such line when the green arrow light first flashes that it cannot safely be stopped before the line;

- (vi) where the signals consist of an additional green light showing the letter “B”, it shall be taken to indicate that any bus in the innermost left lane of the road before the stop line or broken lines on the road provided in conjunction with the signals may —
 - (A) notwithstanding that it would otherwise be required by the illuminated red light to stop; and
 - (B) if its path is not obstructed by another vehicle, pass the signal and proceed straight on;

[S 549/2001 wef 01/11/2001]

- (vii) the illuminated intermittent red light and the illuminated intermittent red arrow light flashing at the rate of between 60 to 80 flashes per minute shall be taken to indicate that vehicles shall stop at the stop line provided in conjunction with the signals and may thereafter, with caution and due regard to the safety of other users of the road and precedence to pedestrians and to traffic in other directions, proceed beyond the stop line;
- (viii) the illuminated intermittent amber light and the illuminated intermittent amber arrow light flashing at the rate of between 60 to 80 flashes per minute shall be taken to indicate that vehicles shall slow down on approaching the signals and may thereafter, with caution and due regard to the safety of other users of the road and precedence to pedestrians, proceed beyond the stop line provided in conjunction with the signals;

- (ix) where allowed by the appropriate sign as shown in diagram 161 (a) or 161 (b) in Part III of the Schedule, a vehicle which —
 - (A) is on a lane from which a left turn or a right turn may, by virtue of any sign or marking as shown in the Schedule, be made; and
 - (B) in compliance with the illuminated red light, has stopped at the stop line or broken lines on the road provided in conjunction with the signals,

may, with caution and due regard to the safety of other users of the road and precedence to pedestrians and to traffic in other directions, proceed beyond the stop line or broken lines and make a left turn or a right turn, as the case may be;
- (x) the illuminated red arrow light shall be taken as prohibiting vehicles from proceeding beyond the stop line or broken lines on the road in that direction, notwithstanding sub-paragraphs (vi) and (ix);
- (xi) the illuminated amber arrow light shall be taken to denote an impending change from green arrow light to red arrow light and as prohibiting vehicles from proceeding beyond the stop line or broken lines on the road provided in conjunction with the signals except in the case of any vehicle which is so close to such line when the amber arrow light first appears that it cannot safely be stopped before the line, notwithstanding that they would otherwise be required by the illuminated green or amber light or lights to proceed on; and
- (xii) the illuminated green arrow light shall be taken to indicate that vehicles, notwithstanding that they would otherwise be required by the illuminated red or amber lights to stop, may proceed in the direction

or directions indicated by the green arrow or arrows with precedence to pedestrians.

[S 13/2000 wef 14/01/2000]

The 2-colour system

12.—(1) In a 2-colour system —

- (a) the signals shall consist of a red and green light; and
- (b) the red light and the green light shall not be illuminated simultaneously.

(2) The 2-colour system shall only be used in temporary installations.

Light signals for lanes

13. In the case of light signals regulating the use of traffic lanes —

- (a) the signals shall consist of 3 lights, which shall be a green downward arrow light, an amber inclined crossed bars light and a red inclined crossed bars light respectively and arranged horizontally facing the direction of approaching traffic;
- (b) the effective diameter of the lens of each light shall be at least 300 mm;
- (c) the height of the centre of the lens of each light above the road shall not be less than 5,200 mm;
- (d) the centres of the lenses of 2 lights placed next to each other shall not be more than 400 mm apart;
- (e) the illuminated green light shall be taken to indicate that vehicles may proceed along the lane over which the light is placed;
- (f) the illuminated intermittent amber flashing light shall be taken to indicate that vehicles may proceed with caution along the lane over which the light is placed; and
- (g) the illuminated red light shall be taken to indicate that vehicles shall not proceed beyond the signal light along the lane over which the light is placed.

Miniature light signals

14. The 3-colour system light signals may be supplemented with miniature light signals which shall be the same as the 3-colour system light signals where the red, amber and green lights are arranged vertically except that —

- (a) the effective diameter of the lens of each light shall be at least 100 mm;
- (b) the height of the centre of the lens of the green light above the road shall be at least 1,200 mm; and
- (c) the centres of the lenses of 2 lights placed next to each other shall not be more than 150 mm apart.

Light signals for pedestrians

15.—(1) Light signals may be used to indicate to pedestrians the period during which they should or should not cross the road.

(2) The light signals for pedestrians shall consist of one red light with the figure of a red man standing upright and one green light with the figure of a green man walking.

(3) The effective diameter of the lens of each light shall not be less than 300 mm.

(4) The height of the centre of the lens of the green light above the road shall be 2,290 mm except that it may be increased where owing to road gradient it is desirable to do so.

(5) The centre of the lenses of the lights shall not be more than 350 mm apart.

(6) The post on which the lights are supported may be painted black and yellow in alternate horizontal bands.

(7) The illuminated red man light shall be taken to indicate that the pedestrian shall not cross the road.

(8) The illuminated green man light shall be taken to indicate that the pedestrian may cross the road.

(9) The flashing green man light shall be taken to indicate that the red man light is about to be illuminated.

Light signals for bicycles

16.—(1) Light signals may be used to indicate to cyclists the period during which they should or should not cross the road, subway or bridge, as the case may be.

(2) The light signals for cyclists shall consist of one red light with the picture of a red bicycle and one green light with the picture of a green bicycle.

(3) The effective diameter of the lens of each light shall not be less than 300 mm.

(4) The height of the centre of the lens of the green light above the surface of the road, including that in a subway or on a bridge, as the case may be, shall be 2,290 mm except that it may be increased where owing to the gradient of the surface it is desirable to do so.

(5) The centre of the lens of the lights shall not be more than 350 mm apart.

(6) The post on which the lights are supported may be painted black and yellow in alternate horizontal bands.

(7) The illuminated red bicycle light shall be taken to indicate that the cyclist shall not cross the road.

(8) The illuminated green bicycle light shall be taken to indicate that the cyclist may cross the road.

(9) The flashing green bicycle light shall be taken to indicate that the red bicycle light is about to be illuminated.

Temporary beacons

17.—(1) Temporary beacons showing an intermittent amber flashing light may be used on special occasions or in connection with road works to assist the safe movement of traffic.

(2) The temporary beacons shall conform to the following provisions:

- (a) the effective diameter of the lenses shall not be less than 125 mm nor more than 200 mm;

- (b) the height of the centre of the lens above the road shall not be less than 1,000 mm nor more than 1,200 mm;
- (c) the rate of flashing shall be between 60 to 80 flashes per minute; and
- (d) the beacons shall be mounted on a beam or a traffic cone or posted on to a barricade.

Temporary signs for road works

18.—(1) Where road works are in progress or where for some other reason the width of the road is temporarily reduced, the traffic signs in diagrams 7 and 8 in Part I of the Schedule may be used to control traffic.

(2) Nothing in this rule shall prevent the use for the purpose stated in paragraph (1) of devices which on 15th November 1991 are already in the possession of the Government, any statutory body which has the lawful authority to break up a road, or the contractors engaged in the business of marking and repairing roads.

THE SCHEDULE

PART I

MANDATORY SIGNS

DIAGRAM 1

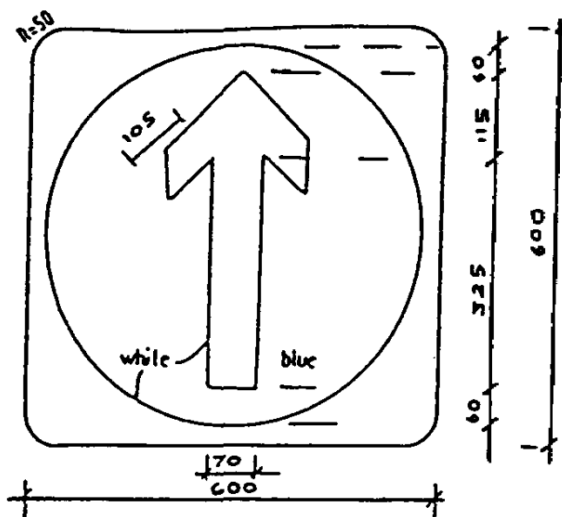

THE SCHEDULE — *continued*

AHEAD ONLY

This sign indicates that vehicles shall only proceed in the direction of the arrow. It may be further qualified when used with supplementary plates.

DIAGRAM 2

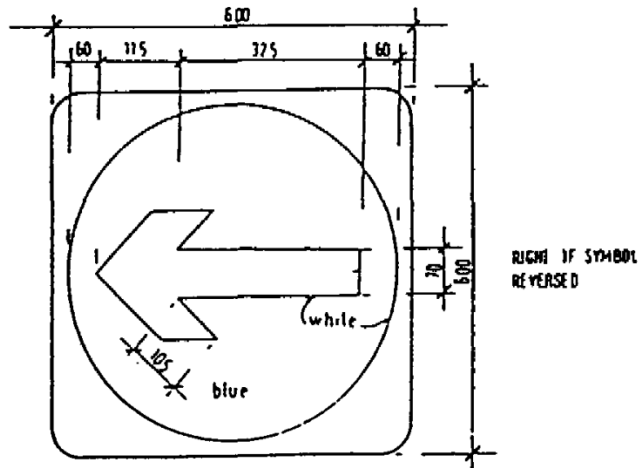

TURN LEFT

The direction of the arrow may be reversed to indicate —

TURN RIGHT

This sign indicates that vehicles shall only proceed in the direction of the arrow. It may be further qualified when used with supplementary plates. It may also be used as a temporary sign to indicate diversion of traffic.

THE SCHEDULE — continued

DIAGRAM 3

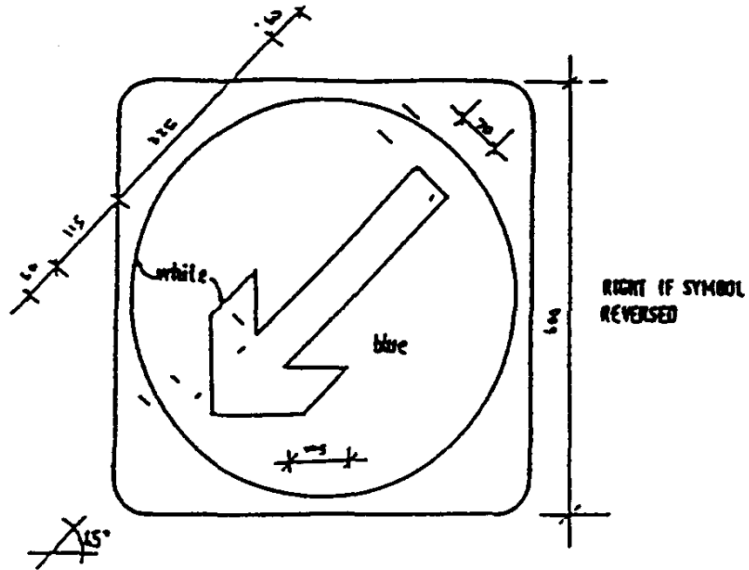

KEEP LEFT

The direction of the arrow may be reversed to indicate —

KEEP RIGHT

This sign indicates that vehicles shall keep left (or right). It may be further qualified when used with supplementary plates.

DIAGRAM 4

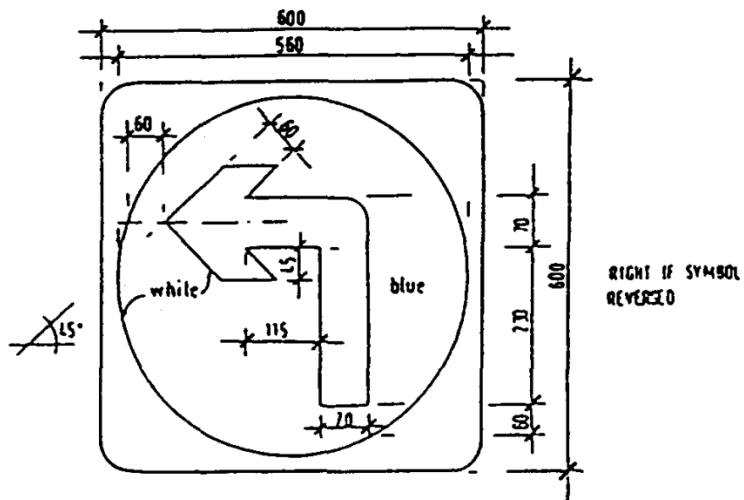

TURN LEFT AHEAD

The direction of the arrow may be reversed to indicate —

THE SCHEDULE — *continued*

TURN RIGHT AHEAD

This sign indicates that vehicles shall only turn in the direction of the arrow at the junction ahead. It may be further qualified when used with supplementary plates.

DIAGRAM 5

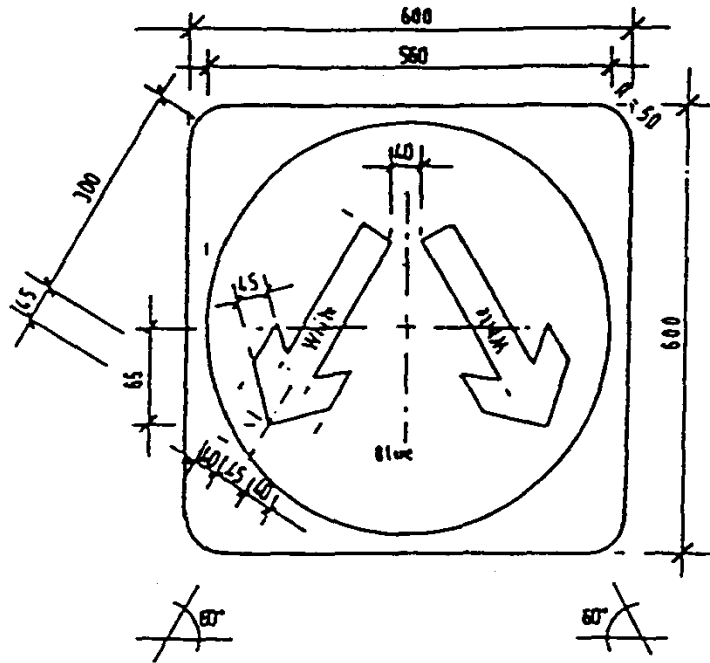

PASS EITHER SIDE

This sign indicates that vehicles shall pass on either side of the sign.

THE SCHEDULE — *continued*

DIAGRAM 6

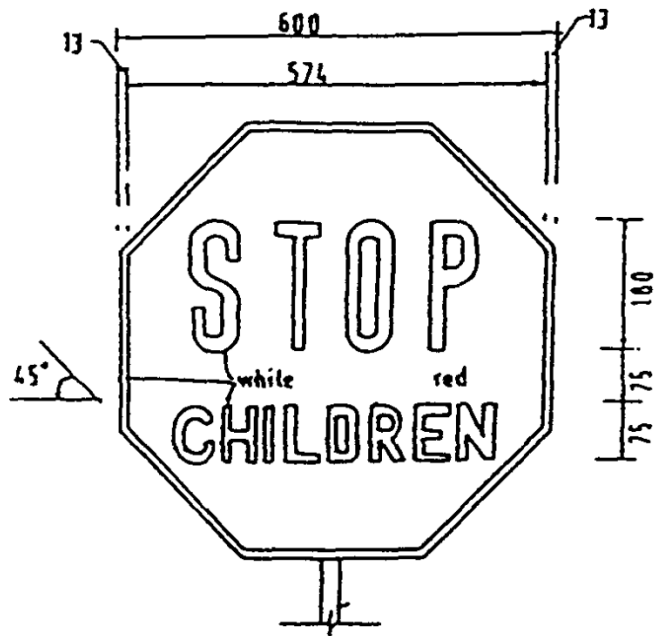

STOP CHILDREN

This sign indicates that vehicles shall not proceed beyond the sign.

DIAGRAM 7

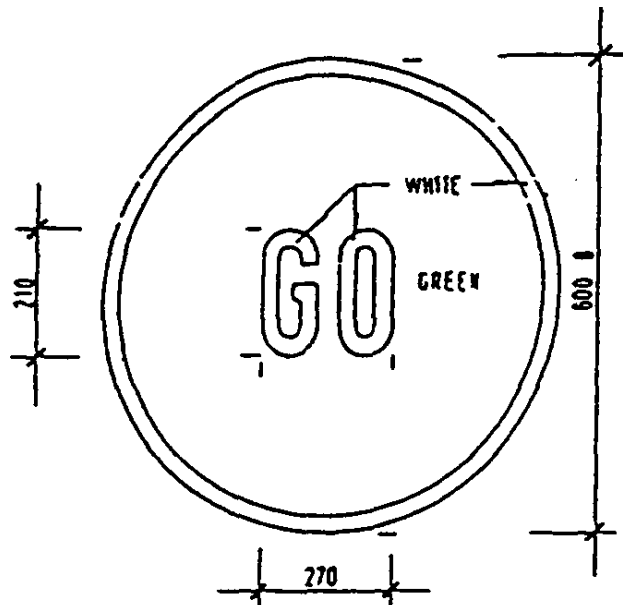

This sign indicates that vehicles may proceed beyond the sign.

THE SCHEDULE — *continued*

DIAGRAM 8

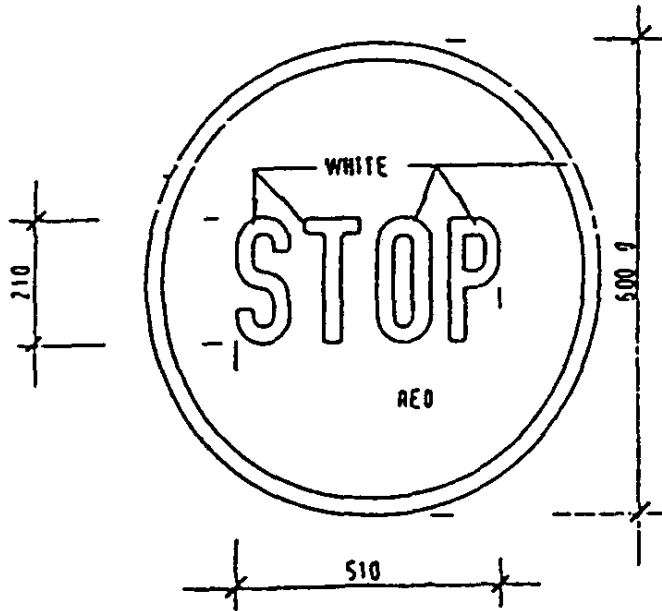

This sign indicates that vehicles shall not proceed beyond the sign.

PRIORITY SIGNS

THE SCHEDULE — continued

DIAGRAM 9

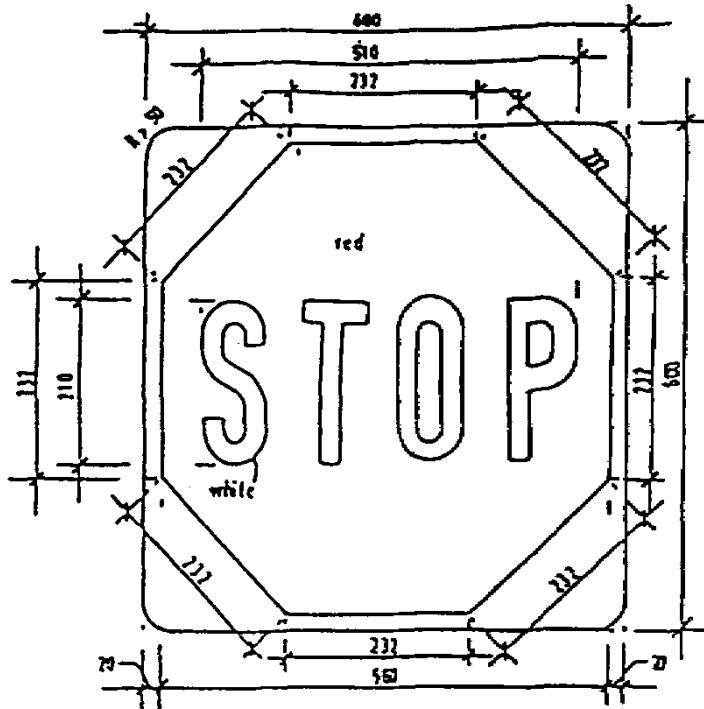

STOP

This sign indicates that vehicles shall, before entering the junction ahead, stop at the transverse stop line drawn in conjunction with the sign.

THE SCHEDULE — *continued*

DIAGRAM 10

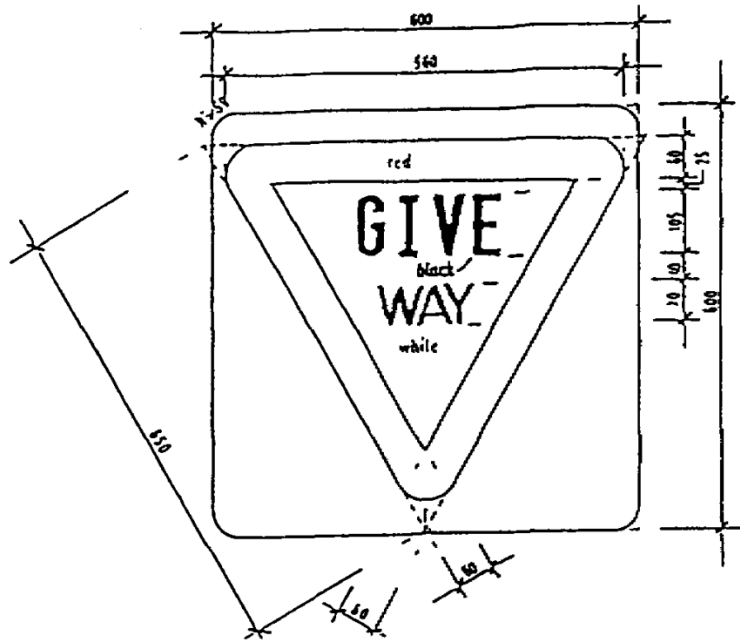

GIVE WAY

This sign indicates that vehicles shall give precedence to the traffic on the left or right, as the case may be.

THE SCHEDULE — *continued*

DIAGRAM 10A

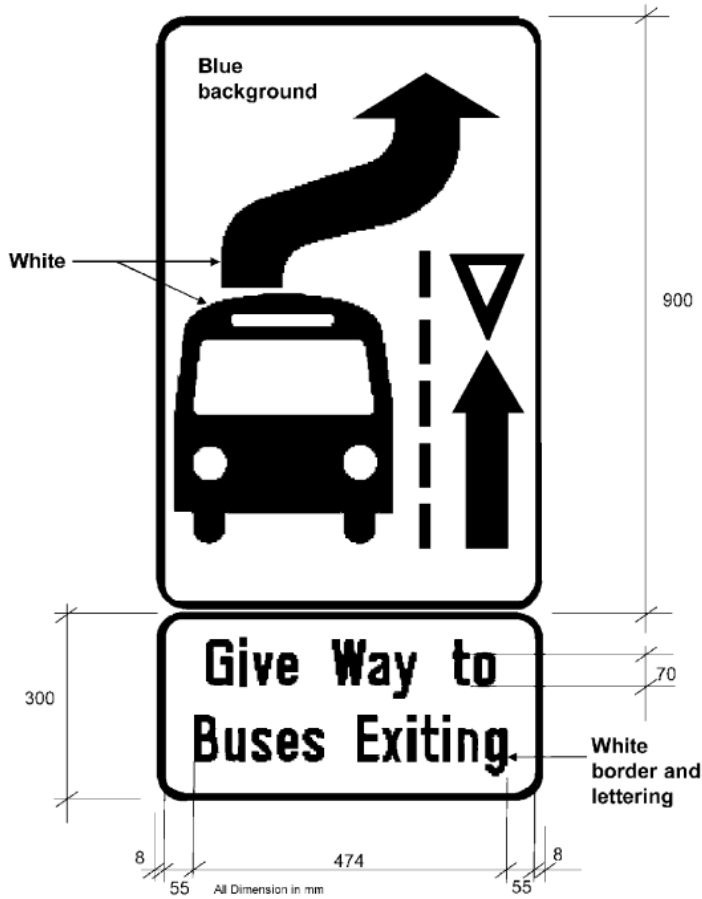

This sign indicates that vehicles shall stop before the Bus Give-Way Line and give precedence to any bus entering or waiting to enter the Bus Give-Way Box.

[S 651/2008 wef 20/12/2008]

PROHIBITORY AND RESTRICTIVE SIGNS

THE SCHEDULE — *continued*

DIAGRAM 11

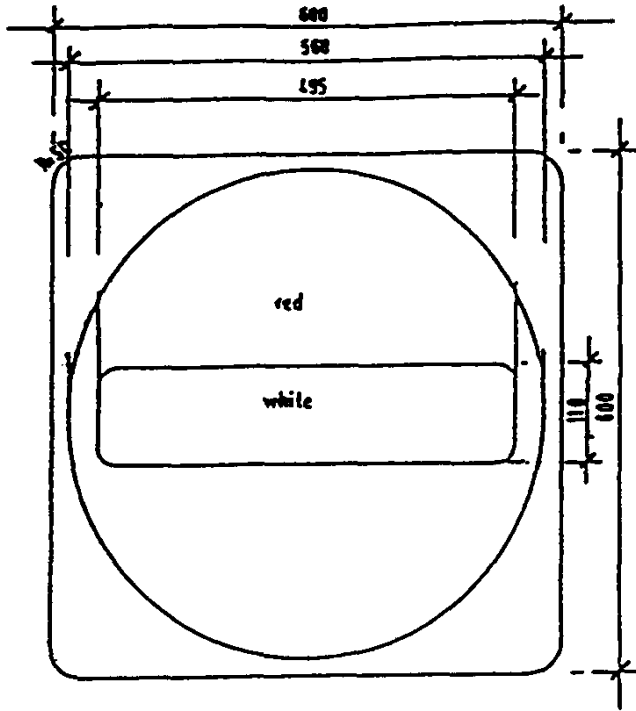

NO ENTRY

This sign prohibits the entry of all vehicles unless otherwise indicated by a supplementary plate.

THE SCHEDULE — *continued*

DIAGRAM 12

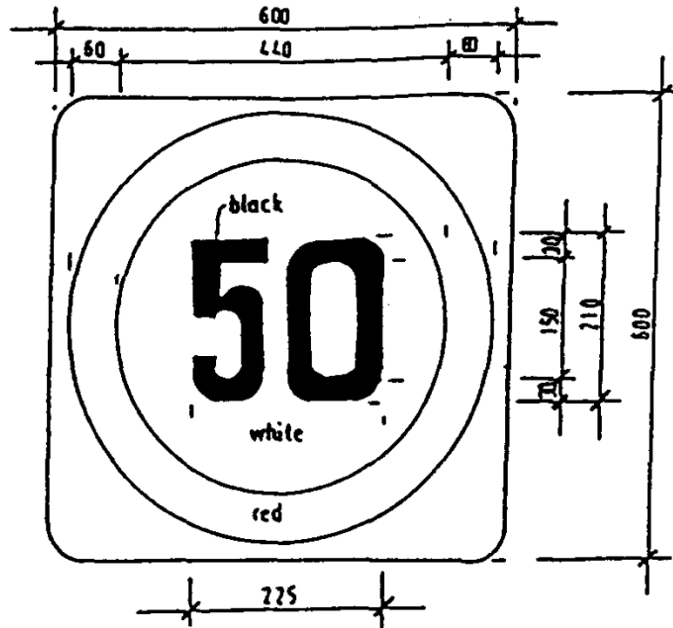

MAXIMUM SPEED LIMIT

This sign indicates that vehicles shall not travel at more than the speed of 50 km per hour. The numerals on the sign may be altered to indicate different speed limit.

THE SCHEDULE — *continued*

DIAGRAM 12A

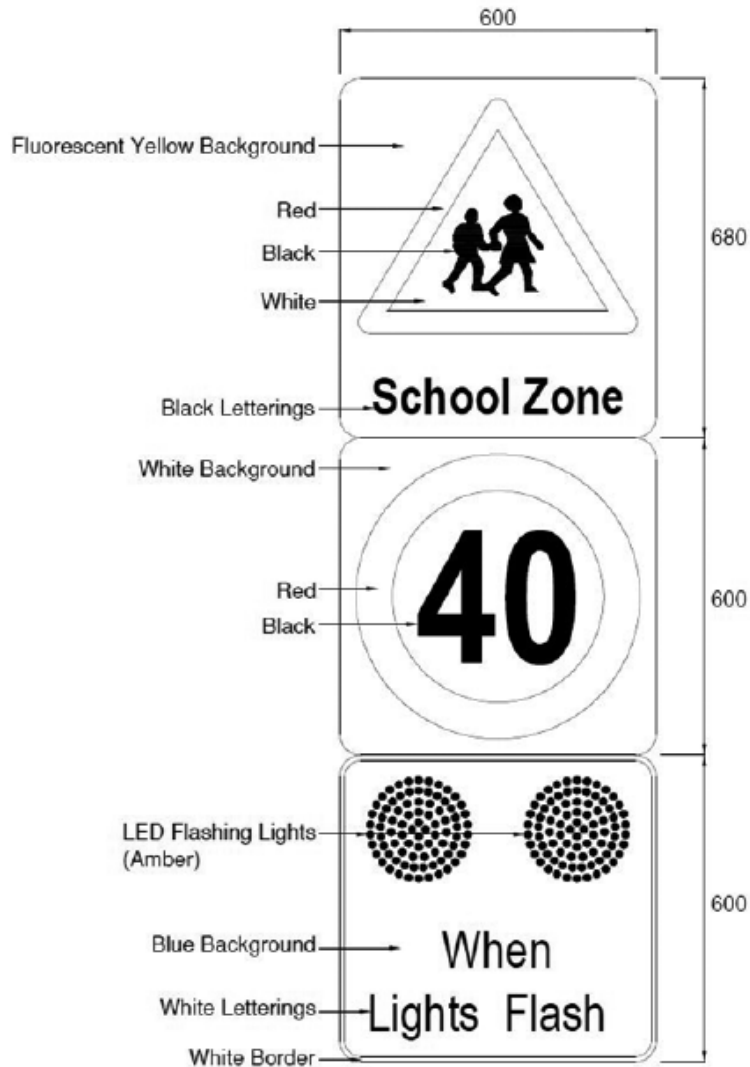

SCHOOL ZONE, 40 KM/H WHEN LIGHTS FLASH

This sign is placed at the start of a demarcated school zone. It indicates that the section of road ahead fronts a school and that vehicles shall not travel at more than 40 km per hour in the school zone when the accompanying amber lights are flashing alternately.

[S 670/2014 wef 01/10/2014]

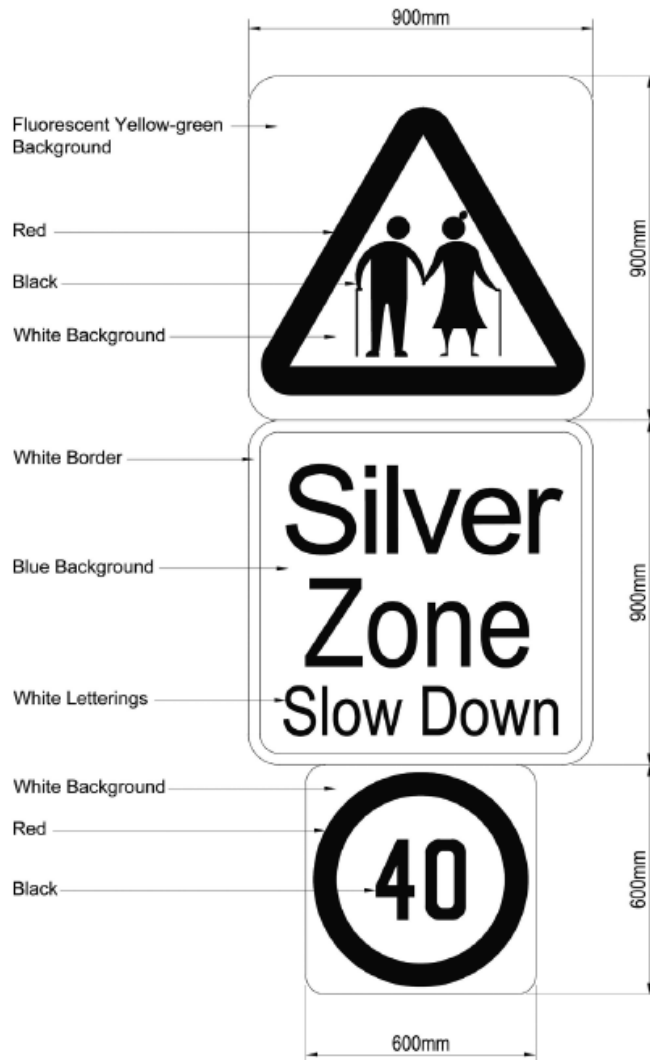
THE SCHEDULE — *continued*DIAGRAM 12B

SILVER ZONE, 40 KM/H

This sign is placed at the start of a demarcated silver zone. It indicates that elderly pedestrians are likely to be encountered in the section of road ahead and that vehicles shall not travel at more than 40 km per hour in the silver zone.

[S 670/2014 wef 01/10/2014]

THE SCHEDULE — *continued*

DIAGRAM 13

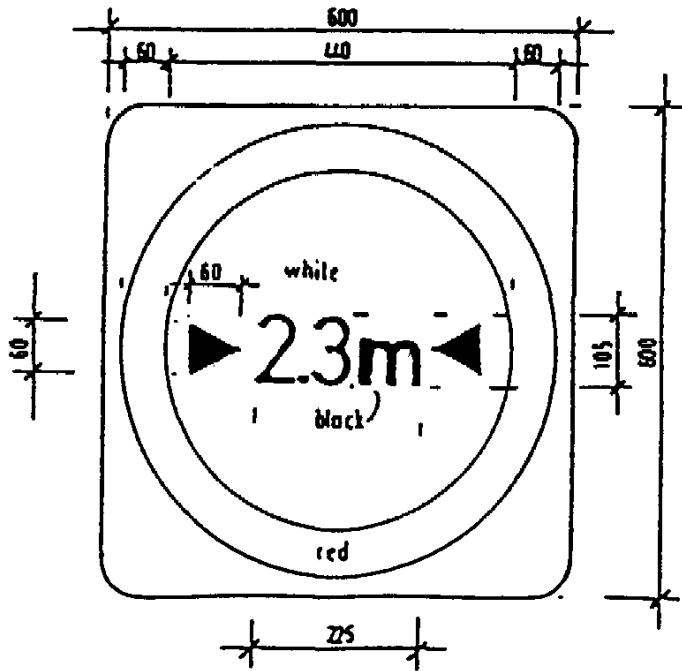

WIDTH LIMIT

This sign prohibits the entry of vehicles with width in excess of 2.3 metres. The numerals on the sign may be altered to indicate different width restriction.

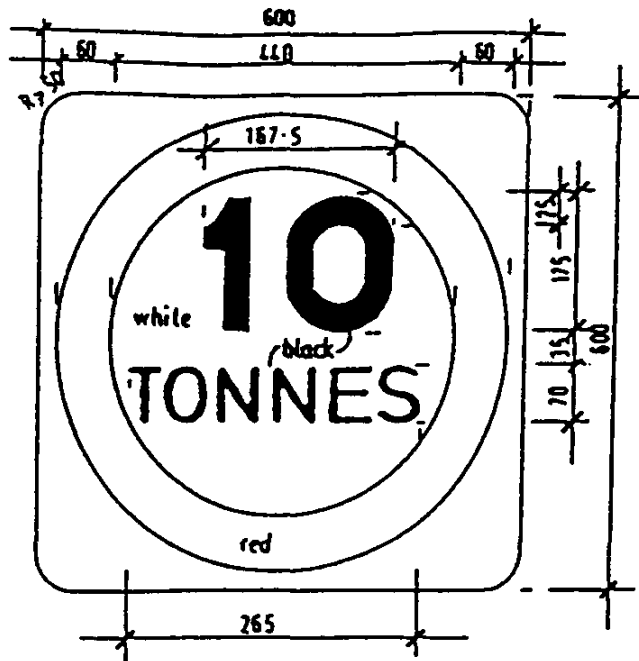
THE SCHEDULE — *continued*DIAGRAM 14

WEIGHT LIMIT

This sign prohibits the entry of vehicles with weight laden or unladen in excess of 10 tonnes. The numerals on the sign may be altered to indicate different weight restriction.

THE SCHEDULE — *continued*

DIAGRAM 15

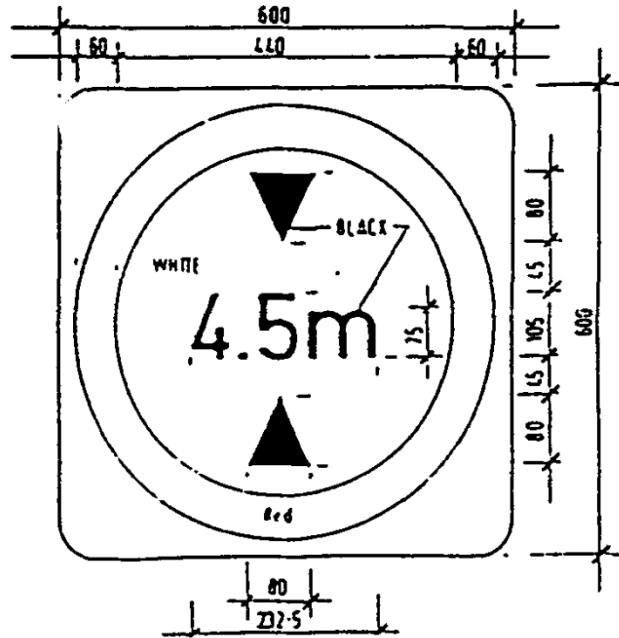

HEIGHT LIMIT

This sign prohibits the entry of vehicles with an overall height in excess of 4.5 metres. The numerals on the sign may be altered to indicate different height restriction.

THE SCHEDULE — continued

DIAGRAM 16

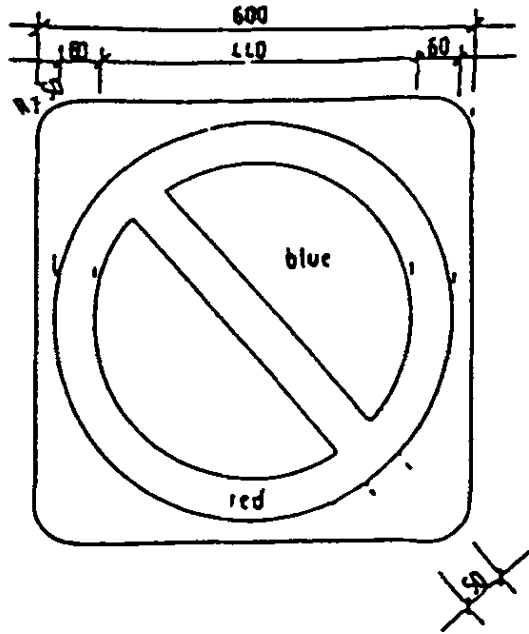

NO WAITING

This sign prohibits the waiting of vehicles. It may be used in conjunction with supplementary plates to indicate the section of the road to which the prohibition applies.

THE SCHEDULE — *continued*

DIAGRAM 16 (a)

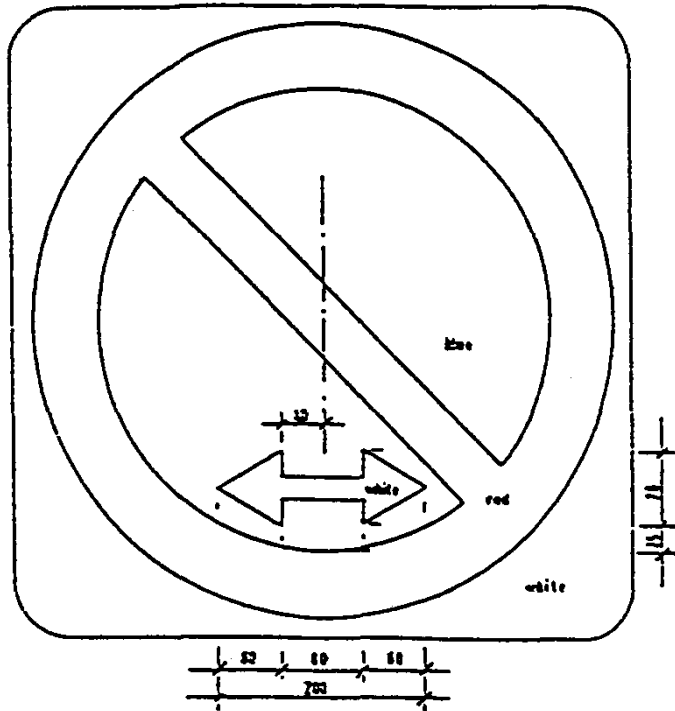

NO WAITING

This sign prohibits the waiting of vehicles.

SCALE: 1:5

THE SCHEDULE — *continued*

DIAGRAM 16 (b)

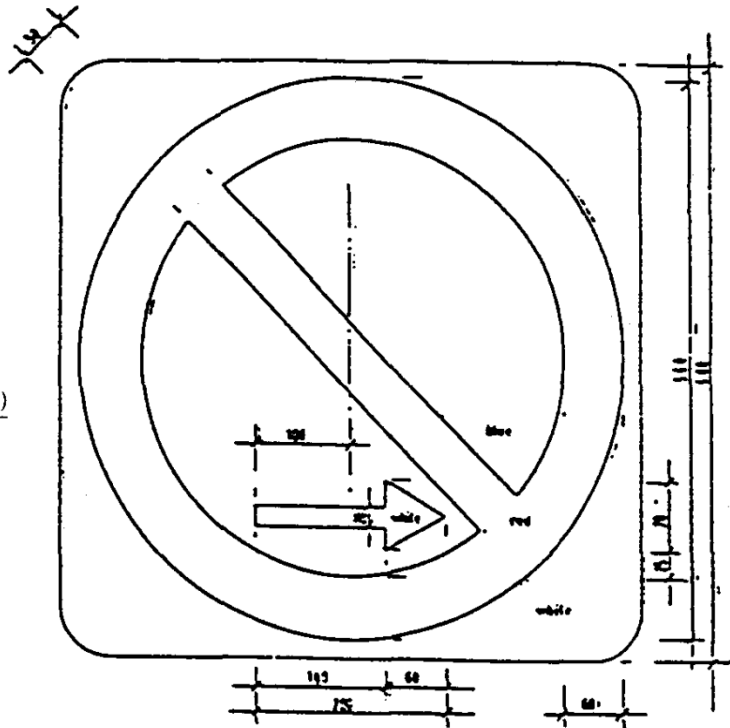

NO WAITING

This sign prohibits the waiting of vehicles, and indicates the point where the prohibition begins.

SCALE: 1:5

THE SCHEDULE — continued

DIAGRAM 16 (c)

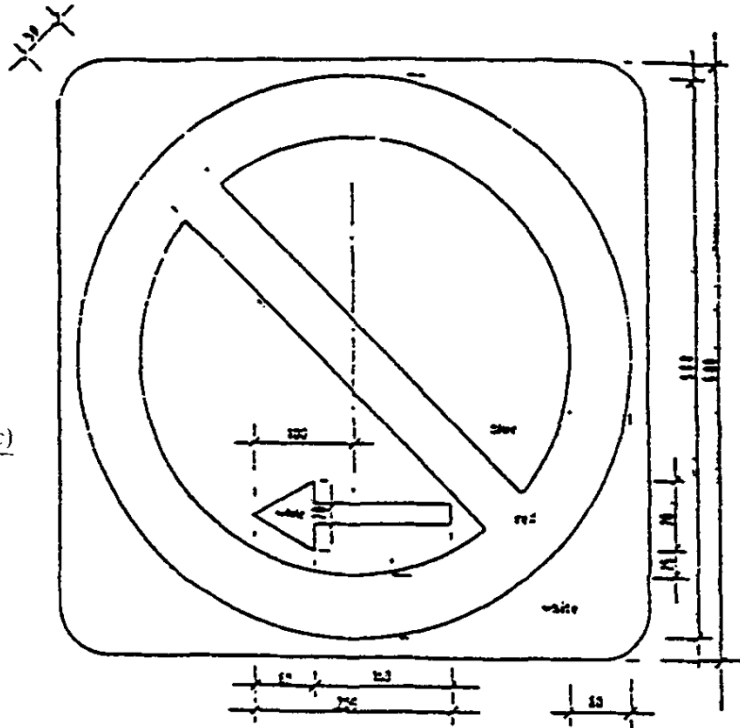

NO WAITING

This sign prohibits the waiting of vehicles, and indicates the point where the prohibition ends.

SCALE: 1:5

THE SCHEDULE — *continued*

DIAGRAM 17

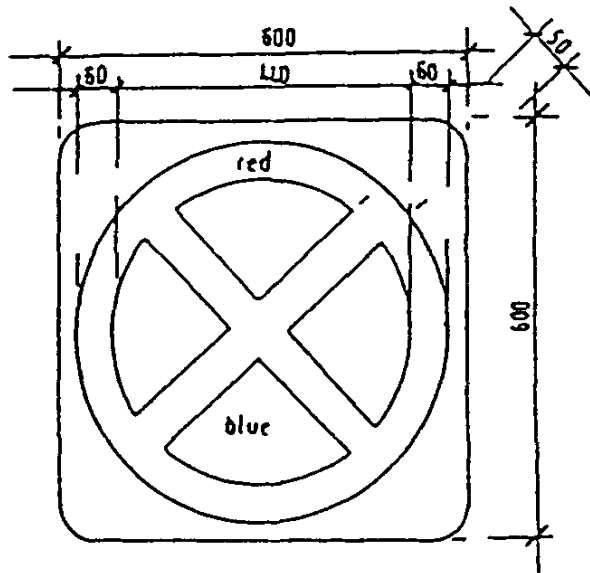

NO STOPPING

This sign prohibits the stopping of vehicles unless the vehicle is prevented from proceeding due to traffic conditions. It may be used in conjunction with supplementary plates to indicate the section of the road to which the prohibition applies.

THE SCHEDULE — *continued*

DIAGRAM 17 (a)

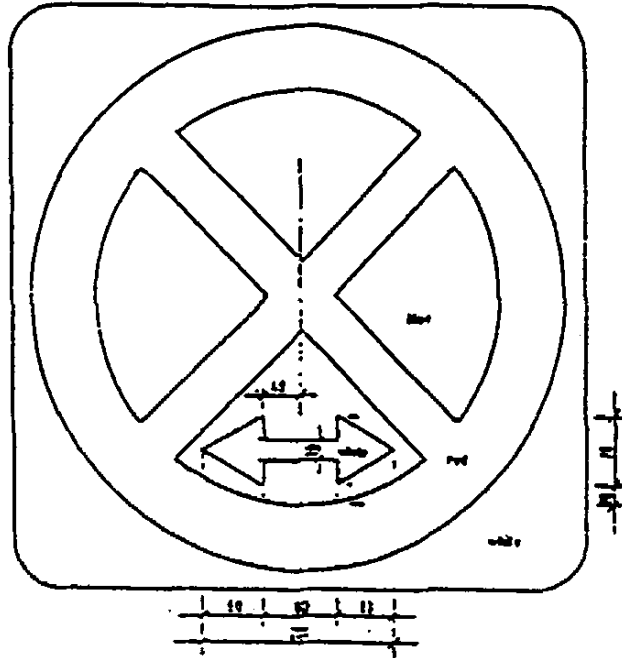

NO STOPPING

This sign prohibits the stopping of vehicles unless the vehicle is prevented from proceeding due to traffic conditions.

SCALE: 1:5

THE SCHEDULE — *continued*

DIAGRAM 17 (b)

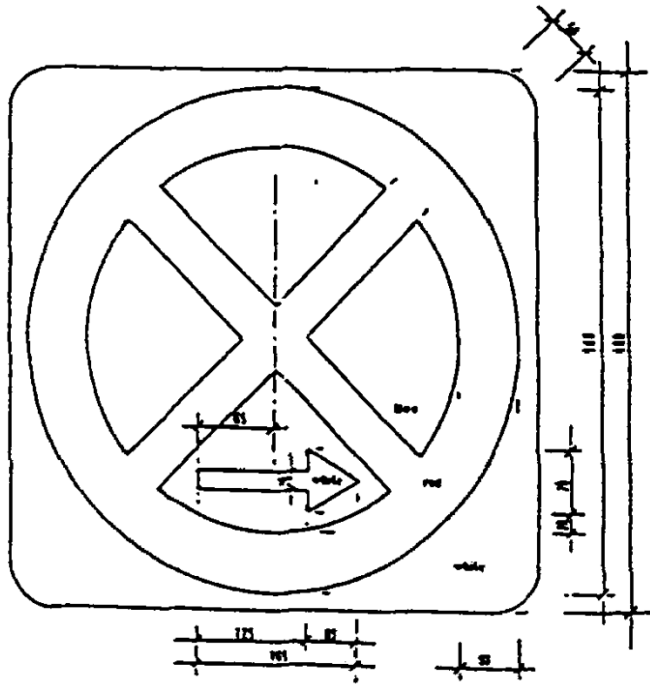

NO STOPPING

This sign prohibits the stopping of vehicles unless the vehicle is prevented from proceeding due to traffic conditions, and indicates the point where the prohibition begins.

SCALE: 1:5

THE SCHEDULE — *continued*

DIAGRAM 17 (c)

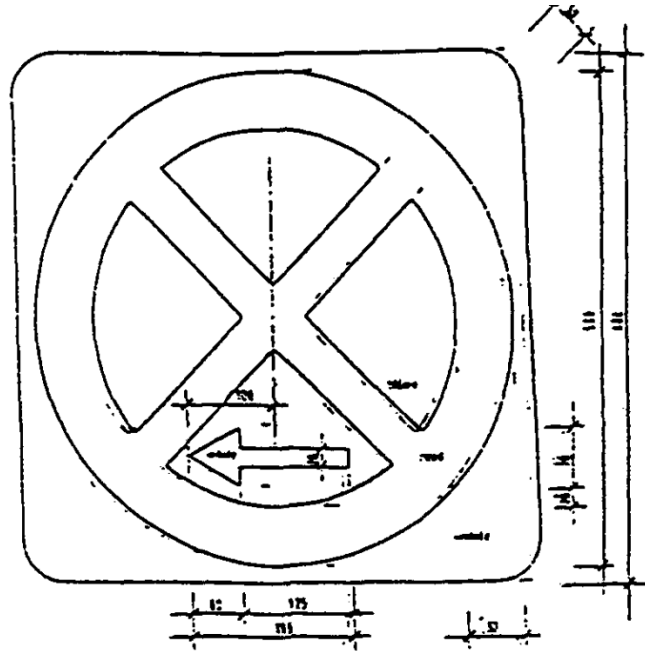

NO STOPPING

This sign prohibits the stopping of vehicles unless the vehicle is prevented from proceeding due to traffic conditions, and indicates the point where the prohibition ends.

SCALE: 1:5

THE SCHEDULE — *continued*

DIAGRAM 18

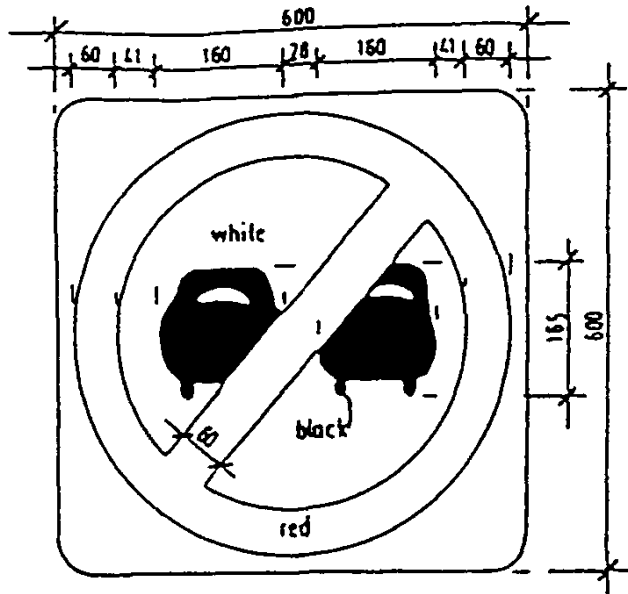

NO OVERTAKING

This sign prohibits the overtaking of motor vehicles. It may be used in conjunction with supplementary plates to indicate the section of the road to which the prohibition applies.

THE SCHEDULE — *continued*

DIAGRAM 19

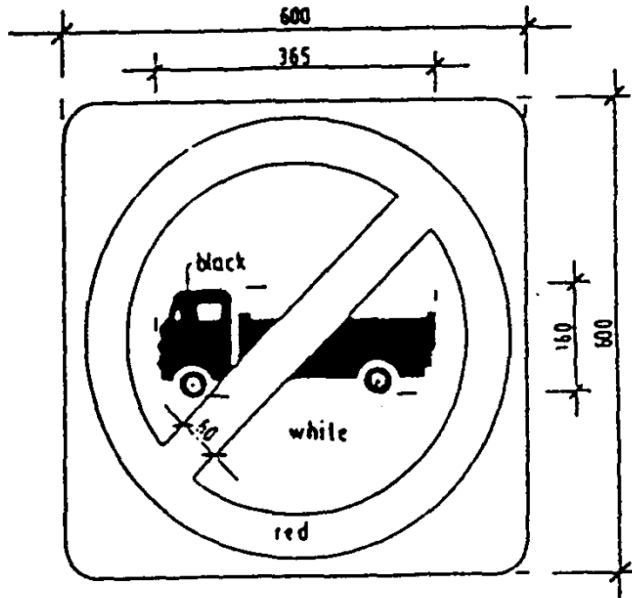

LORRY RESTRICTION

This sign prohibits the entry of all goods vehicles. It may be further qualified when used with supplementary plates eg. “Exceeding 2,500 kg in unladen weight”.

THE SCHEDULE — continued

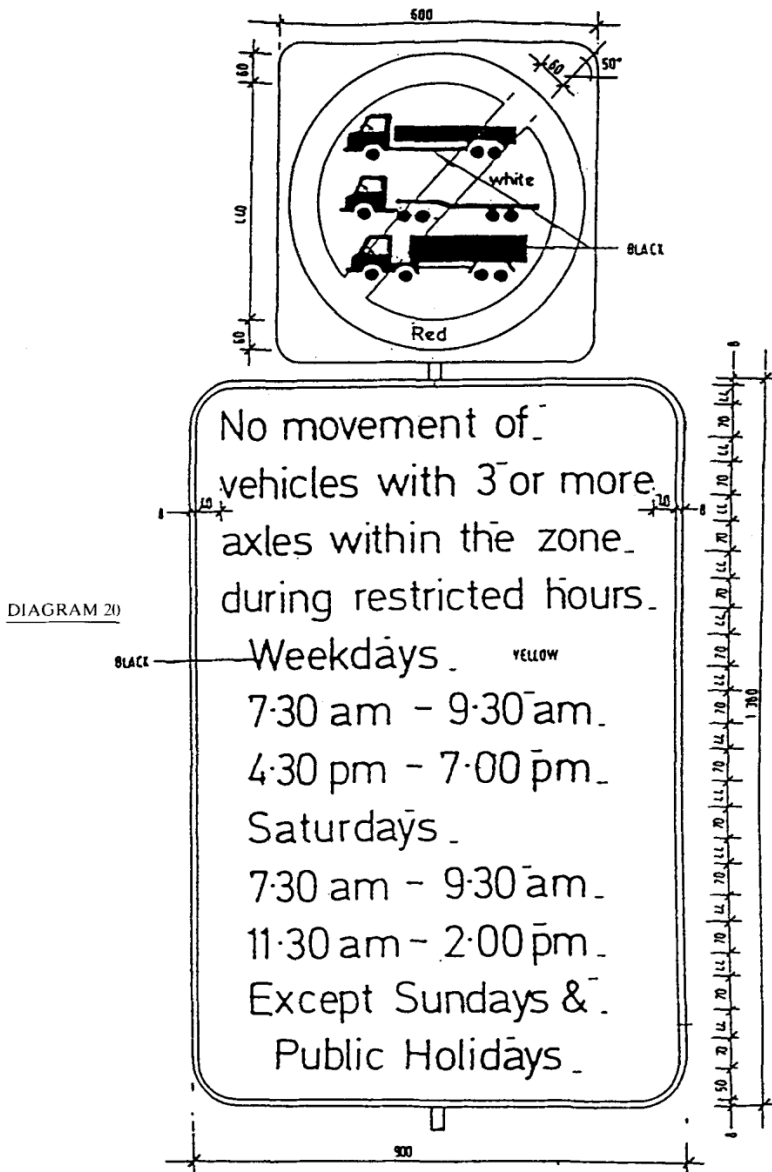

RESTRICTION OF MOVEMENT OF VEHICLES WITH 3 OR MORE AXLES

THE SCHEDULE — *continued*

DIAGRAM 20A

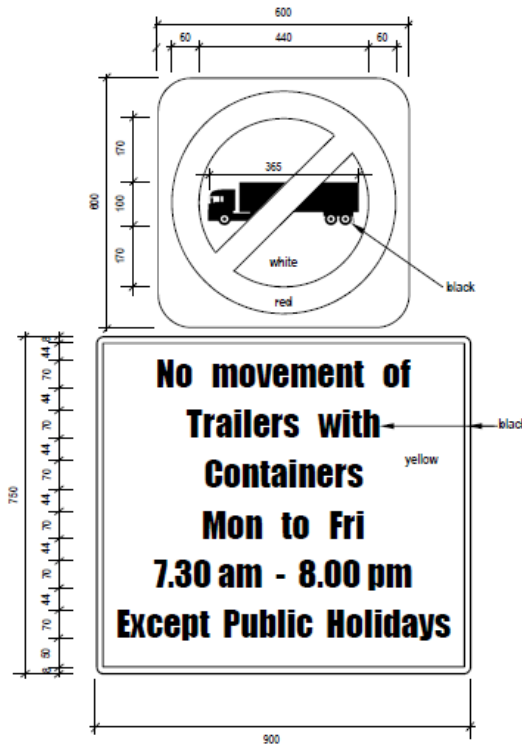

RESTRICTION OF MOVEMENT OF TRAILERS WITH CONTAINERS

This sign prohibits the movement of all trailers with containers on the section of the road beyond the point marked by the sign between 7.30 a.m. and 8 p.m. of any day from Monday to Friday (except public holidays). The days and times on the sign may be altered to indicate different days and times during which the prohibition applies.

[S 814/2013 wef 29/12/2013]

THE SCHEDULE — continued

DIAGRAM 21

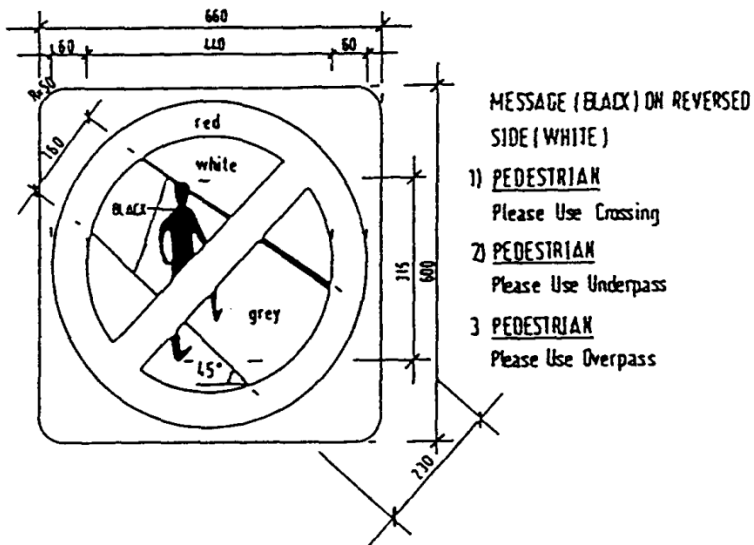

PEDESTRIAN CROSSING PROHIBITION

This sign prohibits pedestrians from crossing the road without using the designated pedestrian crossing. It may be used in conjunction with supplementary plates to indicate the section of the road to which the prohibition applies.

DIAGRAM 22

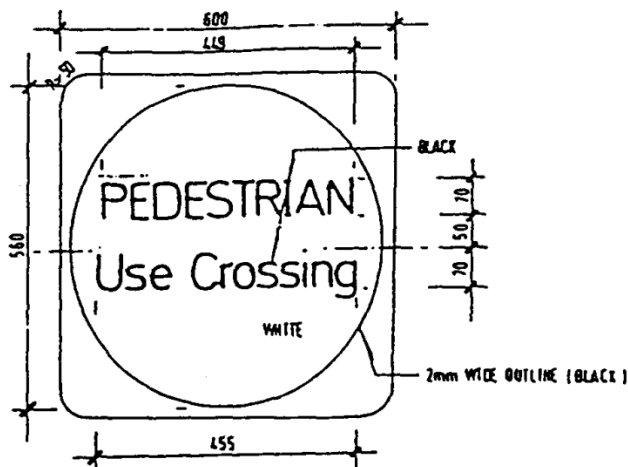

THE SCHEDULE — continued

DIAGRAM 23

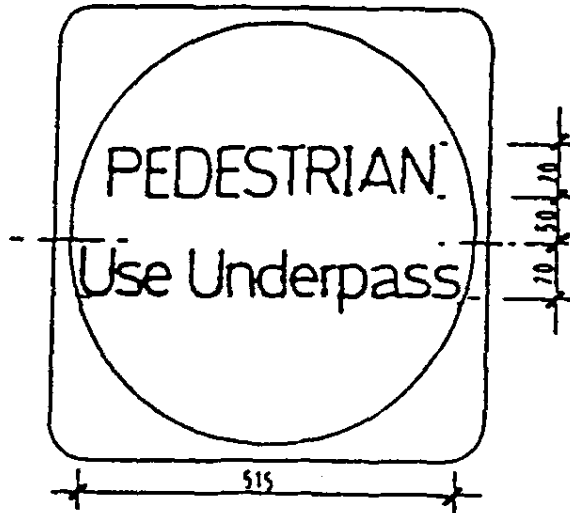
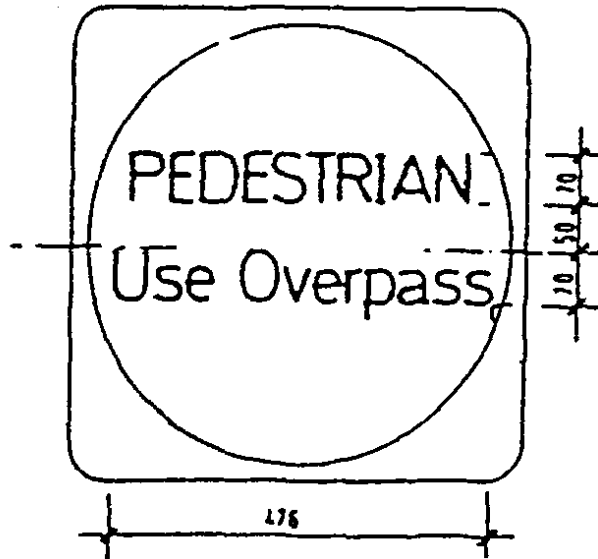
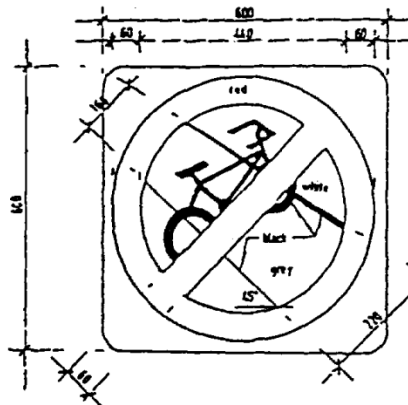

DIAGRAM 24



THE SCHEDULE — *continued*

DIAGRAM 24 (a)



MESSAGE (BLACK)
ON REVERSED SIDE
(WHITE):—

1. CYCLISTS
Please Use Crossing
2. CYCLISTS
Please Use Underpass
3. CYCLISTS
Please Use Overpass

CYCLIST CROSSING PROHIBITION

This sign indicates that cyclists shall not cross that section of the road, subway or bridge, as the case may be, without using the designated bicycle crossing. It may be used in conjunction with supplementary plates to indicate the section of that road, subway or bridge to which the prohibition applies.

DIAGRAM 24 (b)

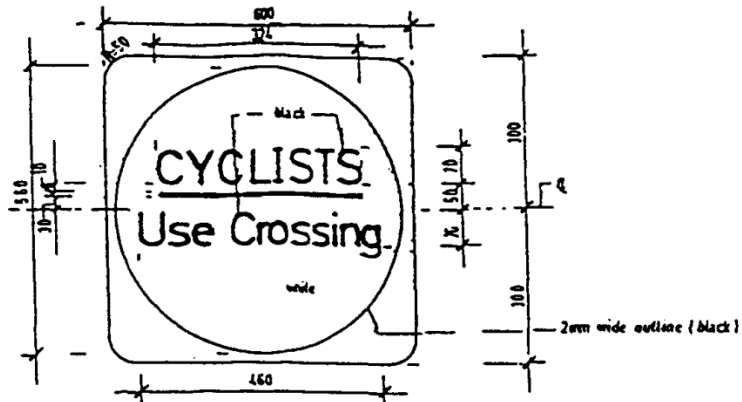

THE SCHEDULE — continued

DIAGRAM 24 (c)

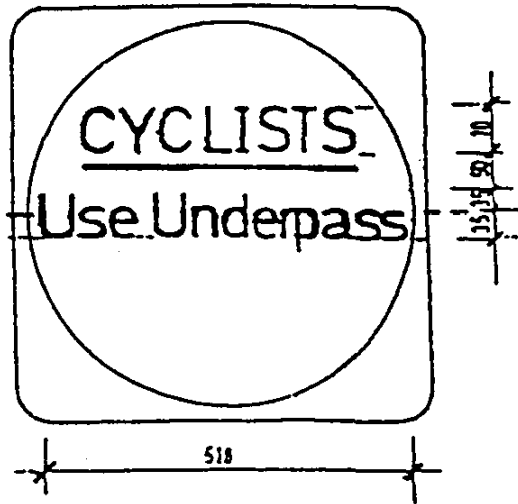
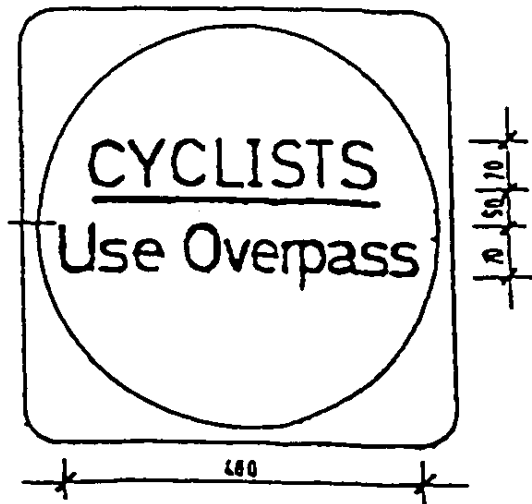

DIAGRAM 24 (d)



CYCLIST CROSSING PROHIBITION
(MESSAGE ON REVERSED SIDE)

THE SCHEDULE — continued

DIAGRAM 25 (a)

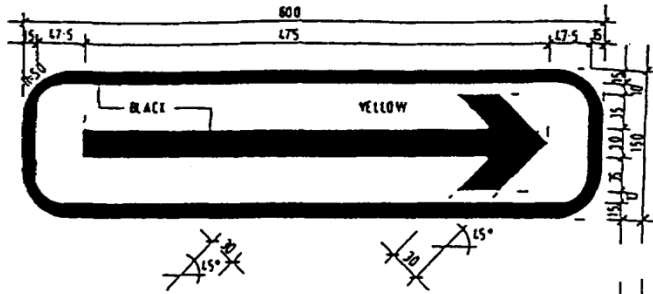
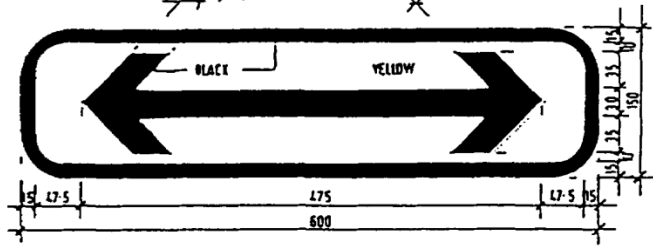

DIAGRAM 25 (b)



DIRECTIONAL ARROWS

These supplementary signs, when used in conjunction with prohibitory or restrictive signs, indicate the section of the road to which the prohibition or restriction applies.

DIAGRAM 26

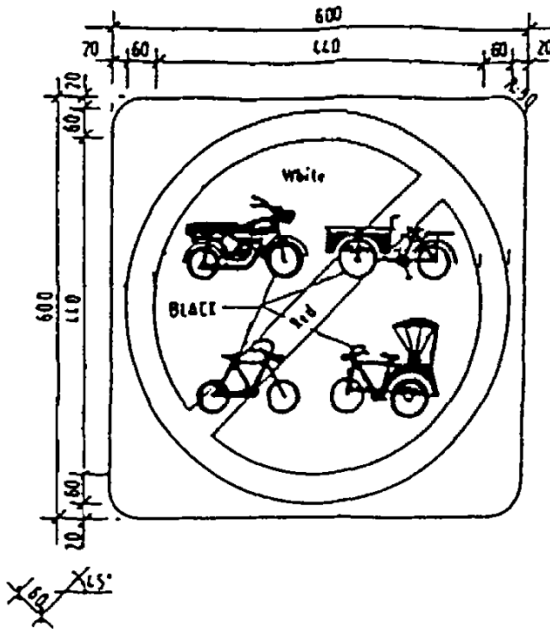

MOTOR CYCLES AND PEDAL-CYCLES RESTRICTION

THE SCHEDULE — *continued*

This sign prohibits the entry of motor cycles and pedal-cycles ie. trishaws, tricycles and bicycles.

DIAGRAM 27

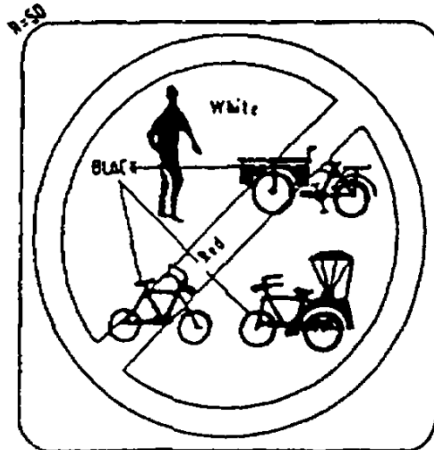

PEDESTRIAN AND PEDAL-CYCLES RESTRICTION

This sign prohibits the entry of pedestrians and pedal-cycles ie. trishaws, tricycles and bicycles.

DIAGRAM 28

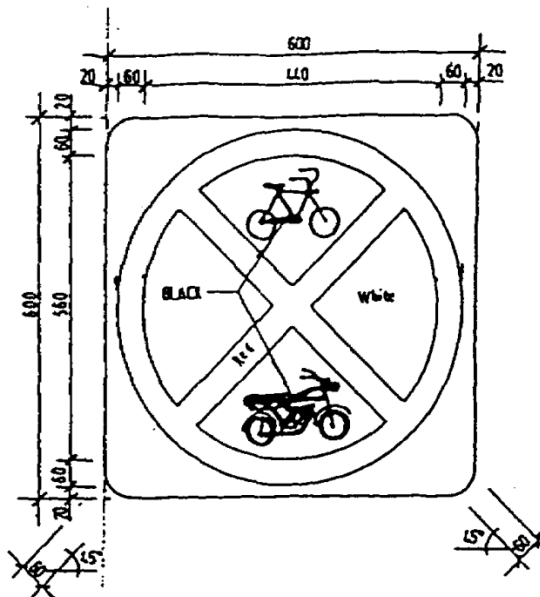

THE SCHEDULE — *continued*

This sign prohibits the parking of motor vehicles with less than 4 wheels weighing not more than 470 kilograms.

DIAGRAM 29

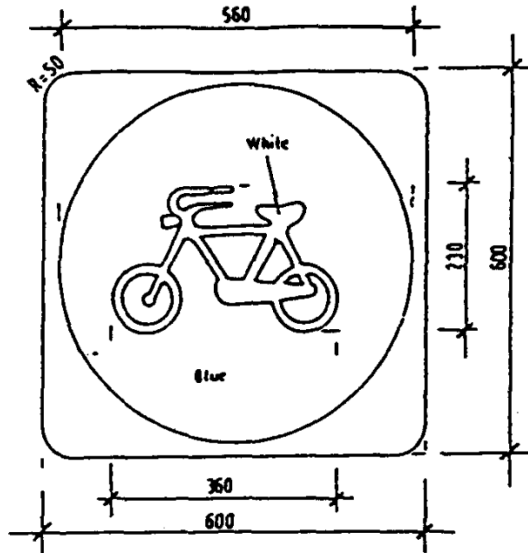

COMPULSORY CYCLE TRACK

This sign indicates that cyclists shall use the cycle track.

DIAGRAM 30

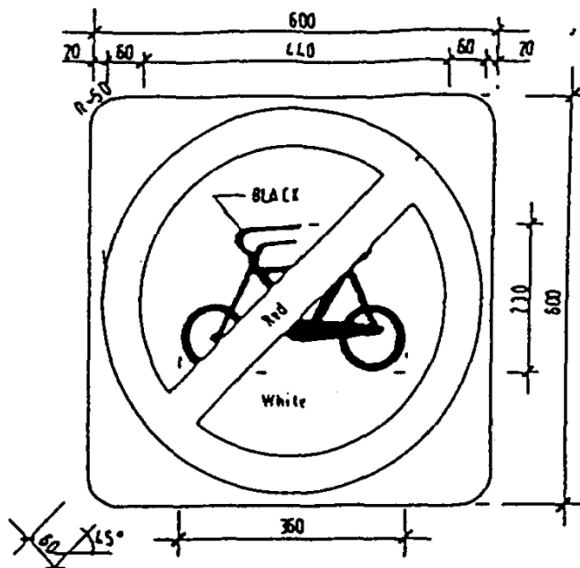

This sign prohibits the entry of bicycles.

THE SCHEDULE — *continued*

DIAGRAM 30A



NO RIDING

This sign prohibits the riding of pedal-cycles, i.e. trishaws, tricycles and bicycles, beyond the point marked by the sign. It may be used in conjunction with supplementary plates to indicate the section of the road to which the prohibition applies.

[S 577/2005 wef 05/09/2005]

THE SCHEDULE — continued

DIAGRAM 31

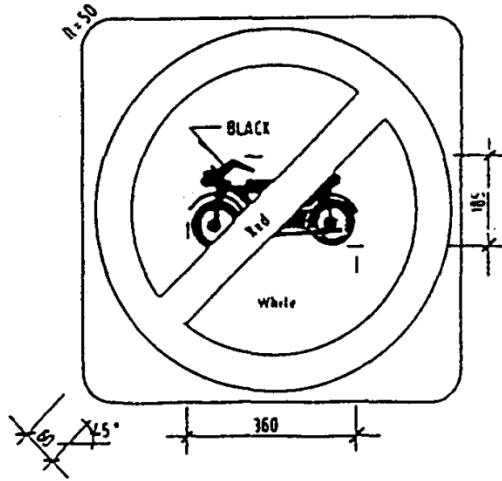

This sign prohibits the entry of motor cycles.

DIAGRAM 32

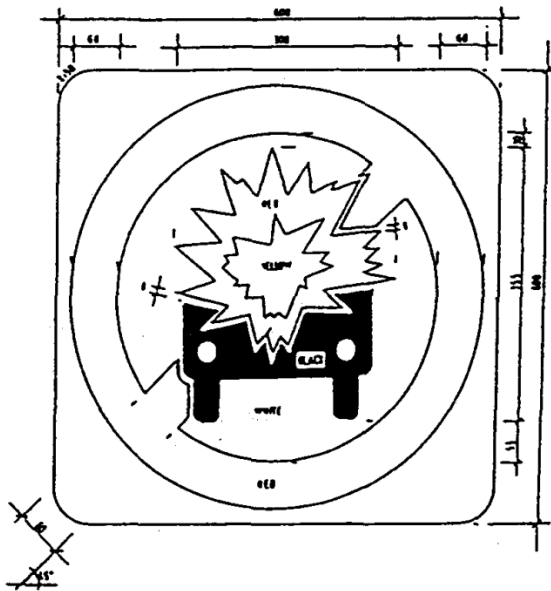

HAZARDOUS LOADS PROHIBITION

This sign prohibits the entry of vehicles transporting hazardous loads.

THE SCHEDULE — *continued*

DIAGRAM 33

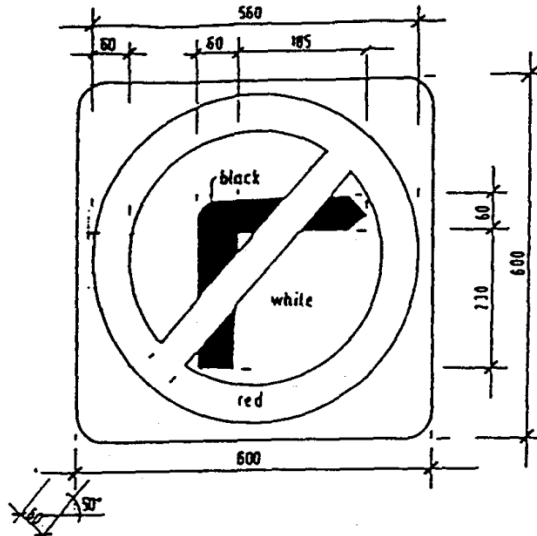

NO RIGHT TURN

This sign prohibits vehicles from turning right at the junction ahead. It may be used in conjunction with traffic light signals and the prohibition may be qualified by a supplementary plate.

DIAGRAM 34

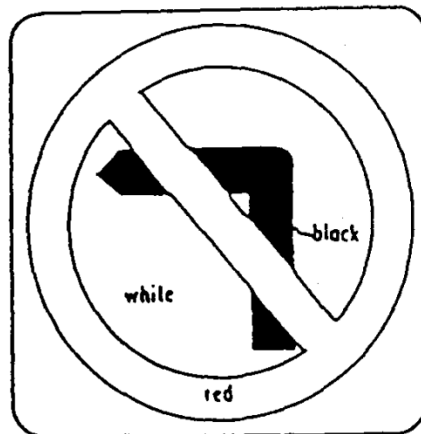

NO LEFT TURN

This sign prohibits vehicles from turning left at the junction ahead. It may be used in conjunction with traffic light signals and the prohibition may be qualified by a supplementary plate.

THE SCHEDULE — continued

DIAGRAM 35

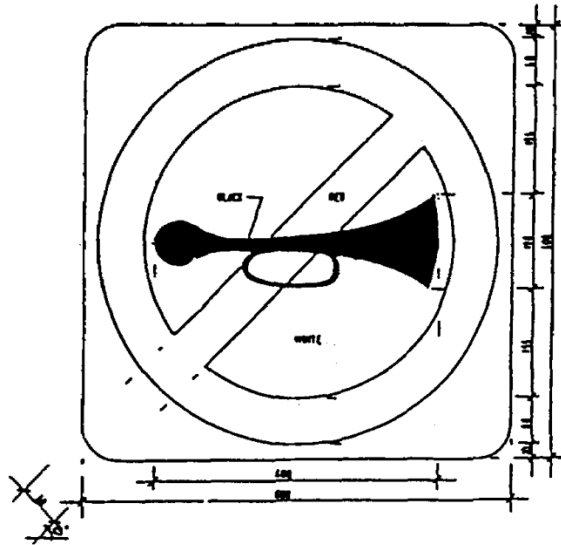

NO HORNING

This sign prohibits horning except in an emergency.

DIAGRAM 36 (a)

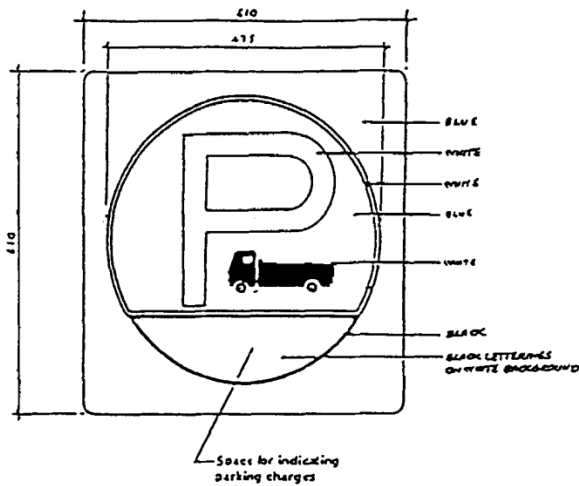

This sign indicates a designated pay parking place for motor vehicles with weight unladen exceeding 1,500 kilograms.

THE SCHEDULE — *continued*

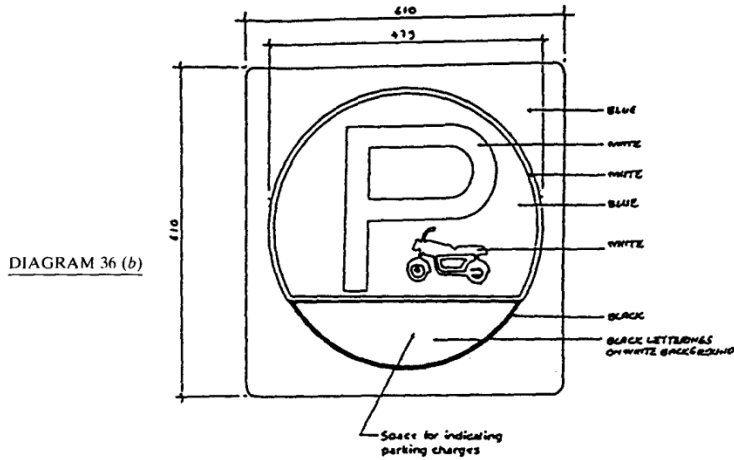

This sign indicates a designated pay parking place for motor vehicles with less than 4 wheels and the weight of which unladen does not exceed 470 kilograms.

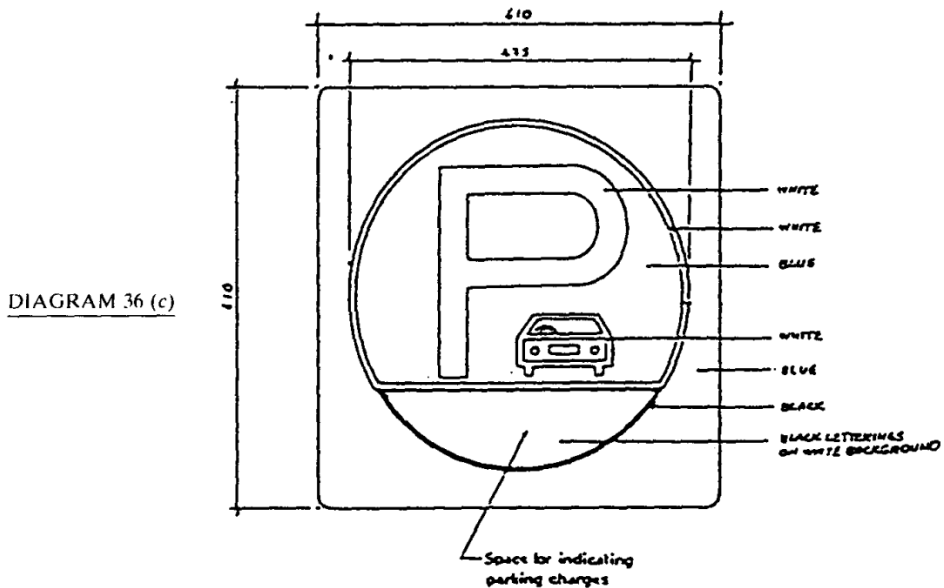

This sign indicates a designated pay parking place for motor vehicles, the weight of which unladen does not exceed 1,500 kilograms.

THE SCHEDULE — *continued*

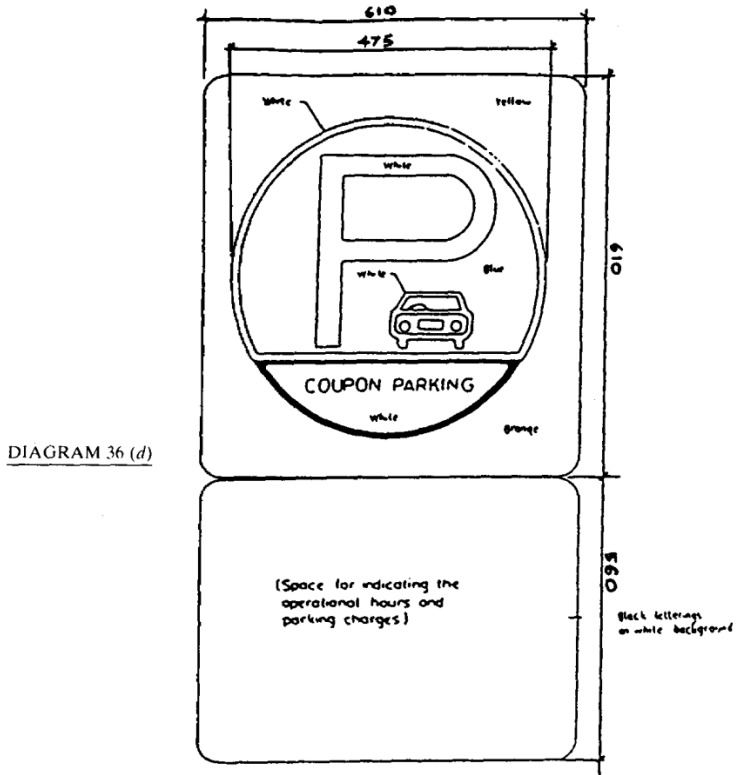
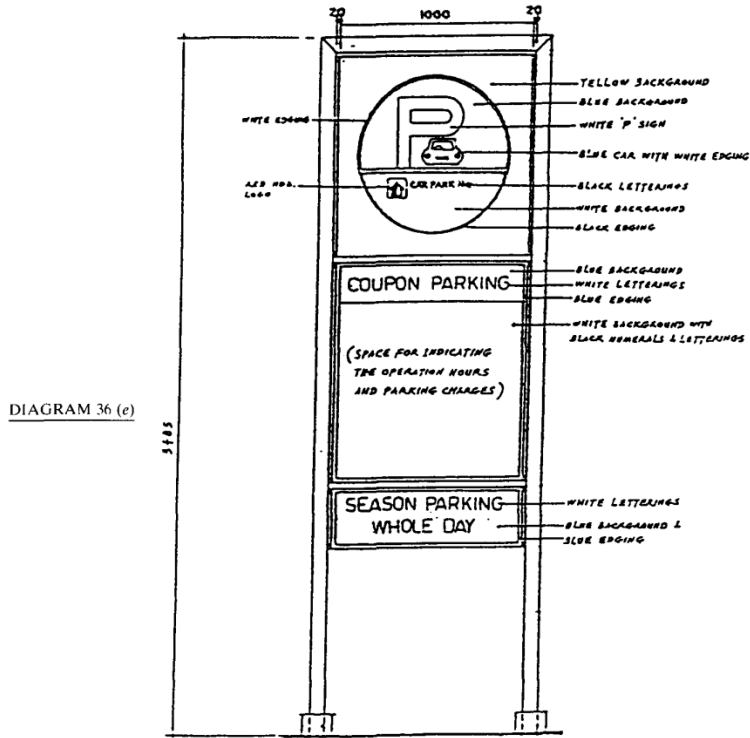

DIAGRAM 36 (d)

PARKING PLACES SIGN (URA)

This sign indicates a designated pay parking place where parking coupons are to be used.

THE SCHEDULE — continued



PARKING PLACE SIGN (HDB)

This sign indicates a designated pay parking place where parking coupons are to be used and/or where season parking is applicable.

THE SCHEDULE — continued

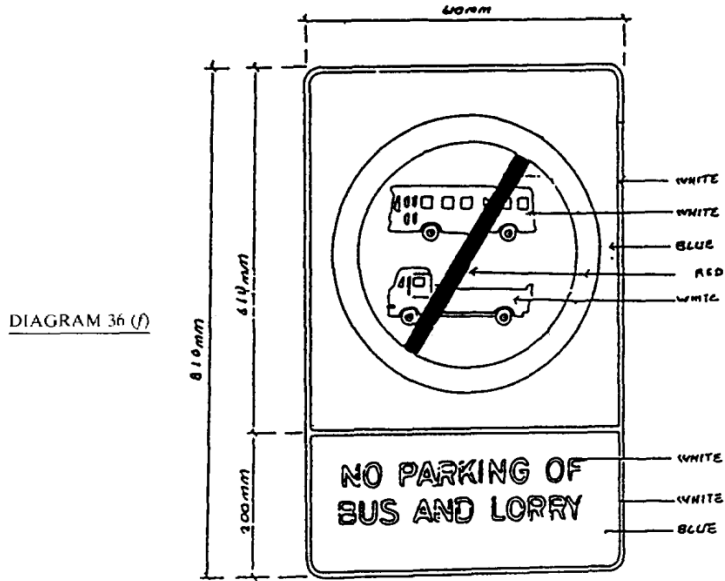

NO PARKING OF BUS AND LORRY

This sign prohibits the parking of buses and lorries.

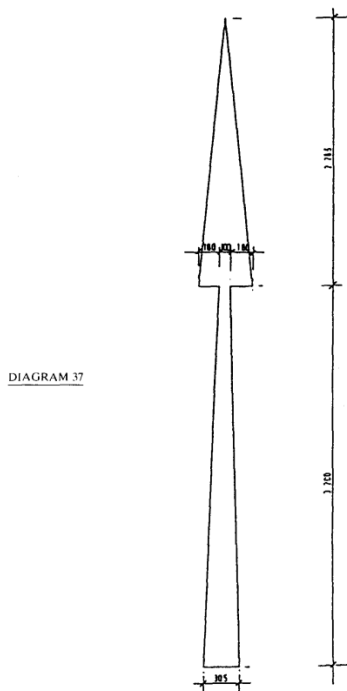

THE SCHEDULE — continued

DIAGRAM 39

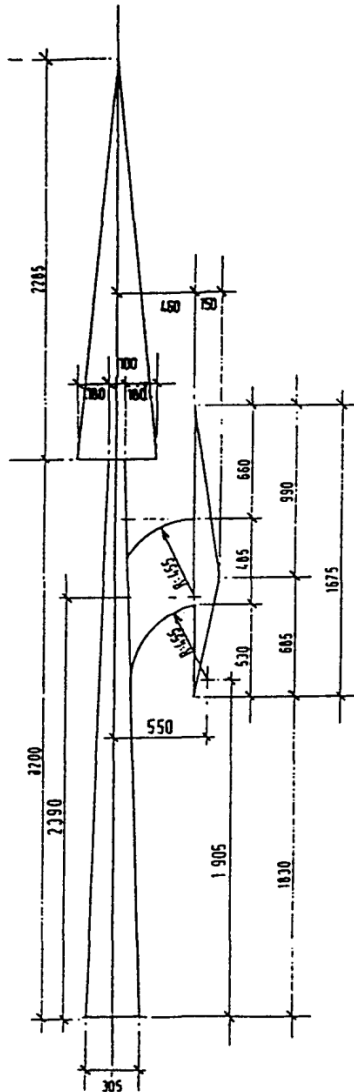

This marking indicates that vehicles on the lane with the marking may only proceed straight ahead or turn right.

THE SCHEDULE — *continued*

DIAGRAM 40

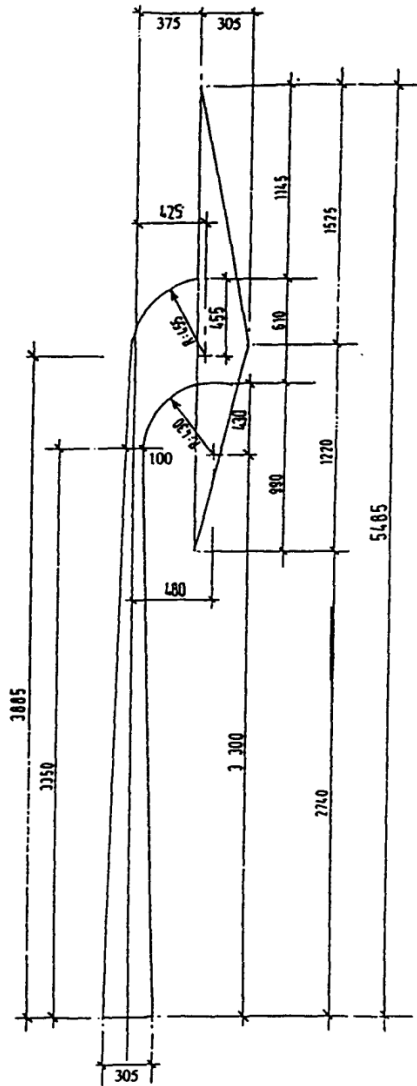

This marking indicates that vehicles on the lane with the marking may only turn right.

THE SCHEDULE — *continued*

DIAGRAM 40A

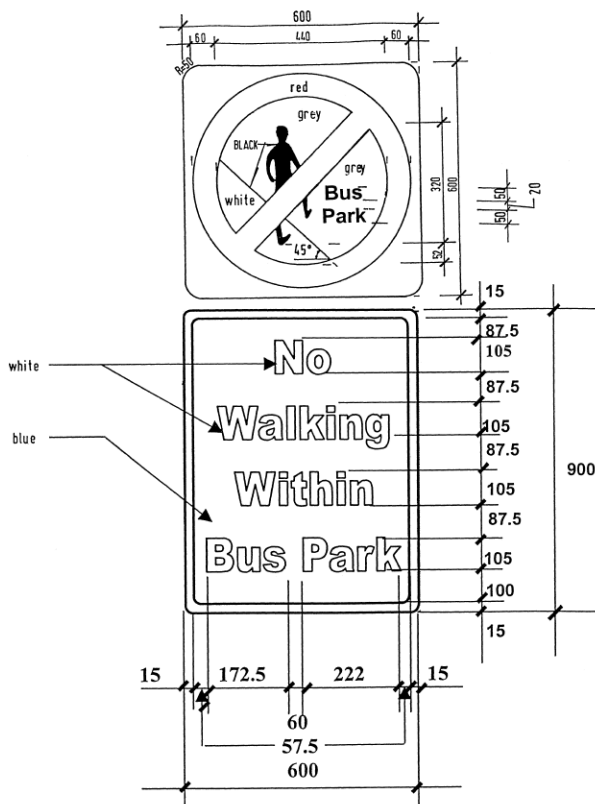

NO WALKING WITHIN BUS PARK

This sign indicates that unauthorised persons are prohibited from walking within the bus park.

[S 334/2003 wef 14/07/2003]

PART II

WARNING SIGNS

THE SCHEDULE — continued

DIAGRAM 41

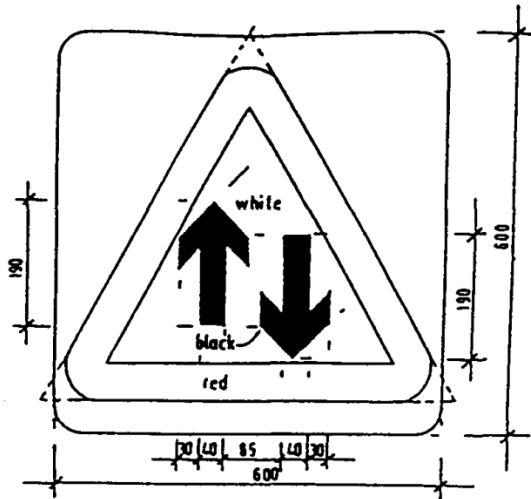

TWO WAY TRAFFIC

This sign indicates that the section of the road ahead carries two-way traffic.

DIAGRAM 42

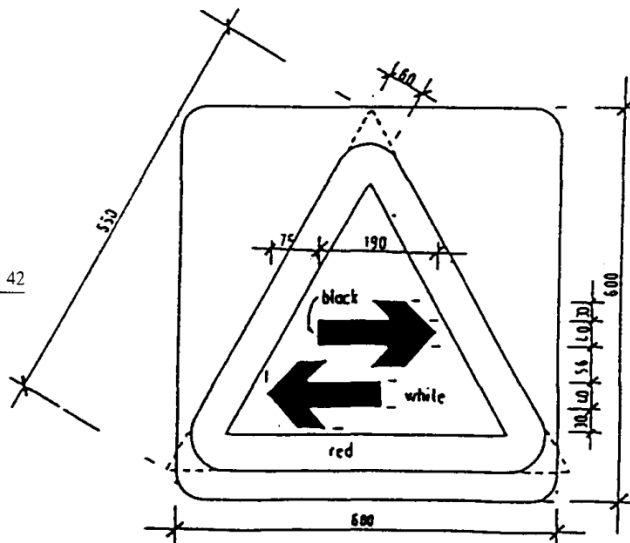

TWO-WAY TRAFFIC ACROSS A ONE-WAY CARRIAGEWAY

This sign indicates that the transverse road ahead carries two-way traffic.

THE SCHEDULE — continued

DIAGRAM 43

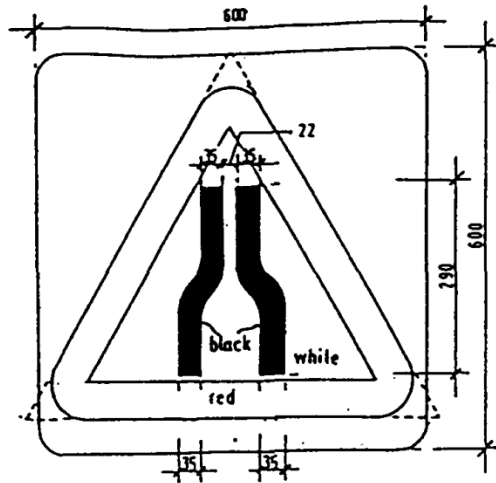

ROAD NARROWS ON BOTH SIDES AHEAD

This sign indicates that the road ahead narrows on both sides.

DIAGRAM 44

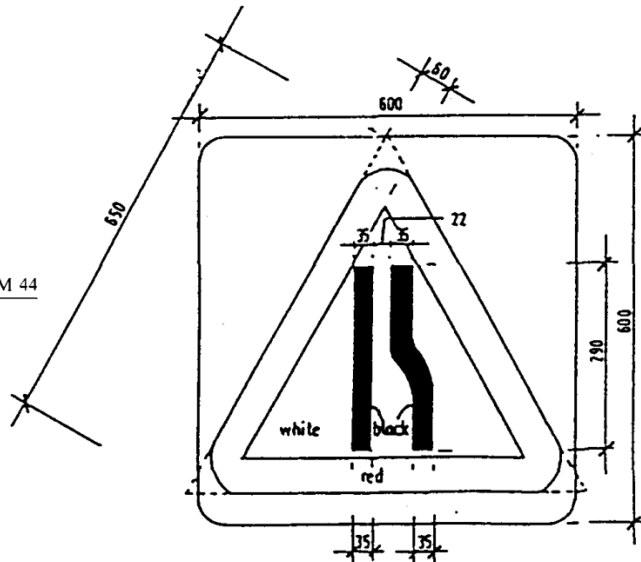

ROAD NARROWS ON RIGHT AHEAD

This symbol may be reversed to indicate —

ROAD NARROWS ON LEFT AHEAD

This sign indicates that the road ahead narrows on the right (or left) side.

THE SCHEDULE — *continued*

DIAGRAM 45

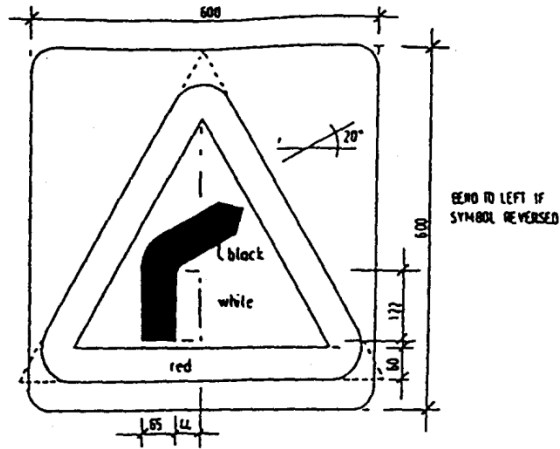

BEND TO THE RIGHT AHEAD

This symbol may be reversed to point to the left to indicate —

BEND TO THE LEFT AHEAD

This sign indicates that the road ahead bends to the right (or left).

DIAGRAM 46

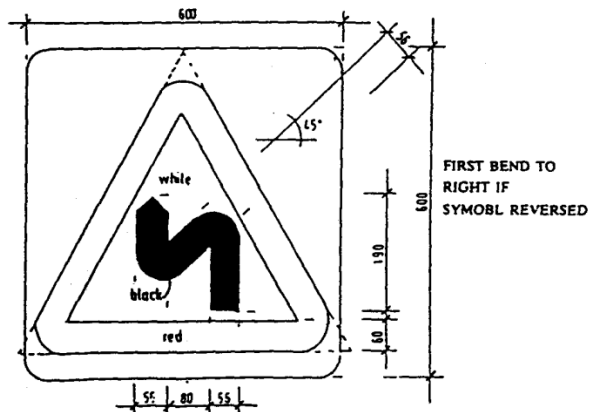

DOUBLE BEND AHEAD, FIRST TO THE LEFT

This symbol may be reversed to indicate —

DOUBLE BEND AHEAD, FIRST TO THE RIGHT

This sign indicates that there is a double bend of the road ahead.

THE SCHEDULE — continued

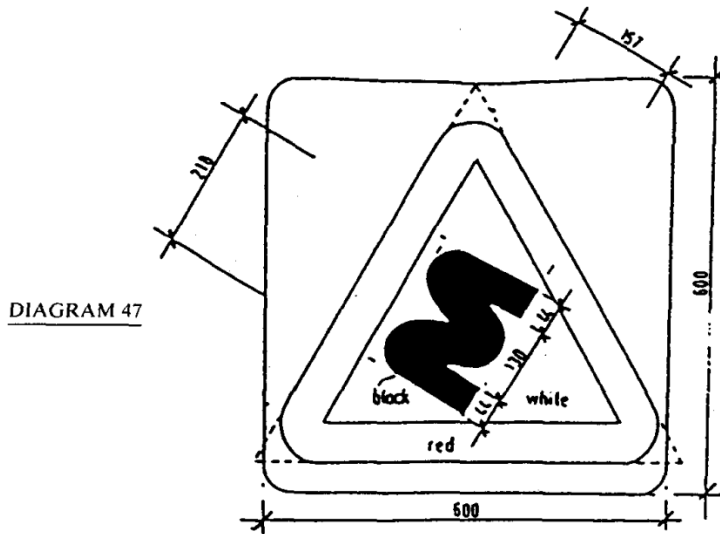

SERIES OF BENDS FIRST TO THE RIGHT

This symbol may be reversed to indicate —

SERIES OF BENDS FIRST TO THE LEFT

This sign indicates that there is a series of bends of the road ahead.

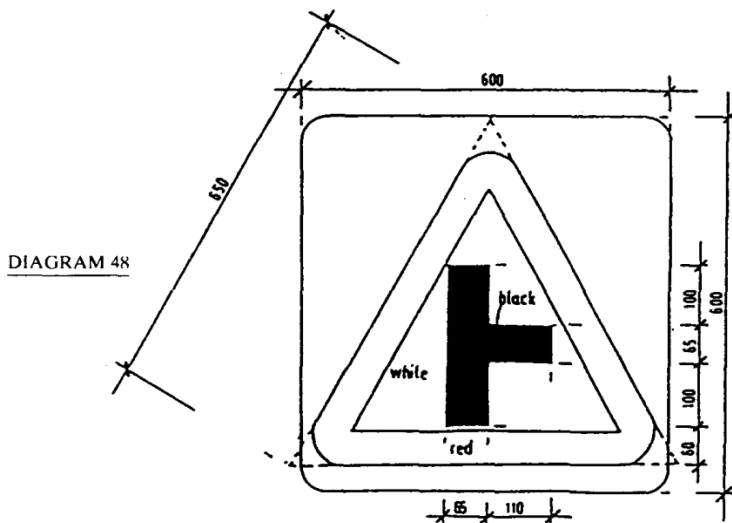

SIDE ROAD TO THE RIGHT

This symbol may be reversed to indicate —

SIDE ROAD TO THE LEFT

THE SCHEDULE — *continued*

This sign indicates that there is a side road junction ahead.

DIAGRAM 49

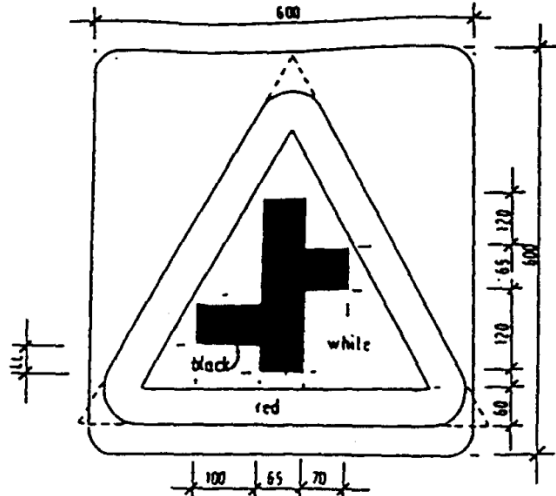

STAGGERED JUNCTION, LEFT TURN FIRST

This symbol may be reversed to indicate —

STAGGERED JUNCTION, RIGHT TURN FIRST

This sign indicates that there is a staggered junction ahead.

DIAGRAM 50

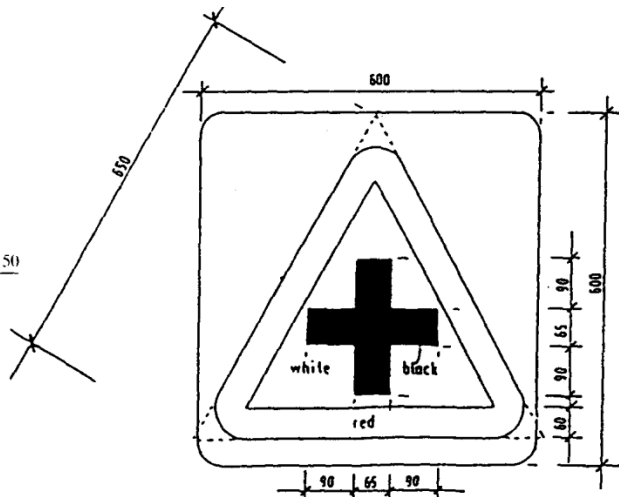

CROSS ROADS

This sign indicates that there is a cross roads junction ahead.

THE SCHEDULE — *continued*

DIAGRAM 51

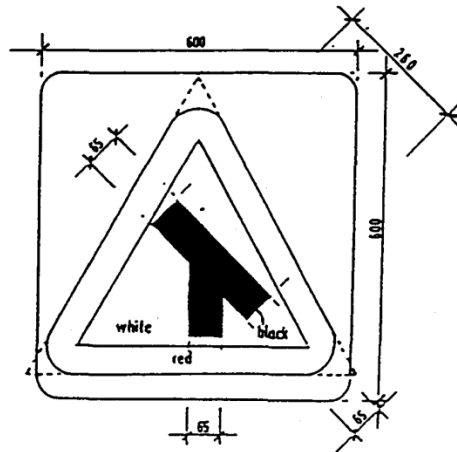

MERGING INTO TRAFFIC ON RIGHT

This symbol may be reversed to indicate —

MERGING INTO TRAFFIC ON LEFT

This sign indicates that there a junction ahead where traffic on this road will merge with the traffic on the adjoining road.

DIAGRAM 52

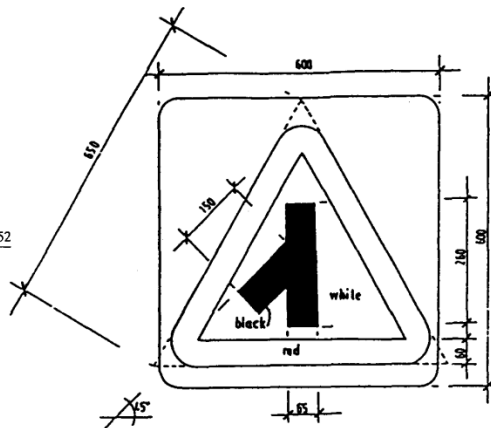

TRAFFIC MERGES FROM LEFT

This symbol may be reversed to indicate —

TRAFFIC MERGES FROM RIGHT

This sign indicates that traffic on the adjoining road will merge into traffic on this road.

THE SCHEDULE — continued

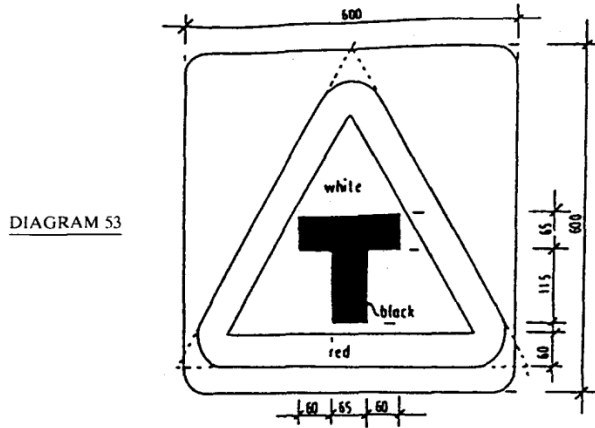

T-JUNCTION

This sign indicates that there is a T-junction ahead.

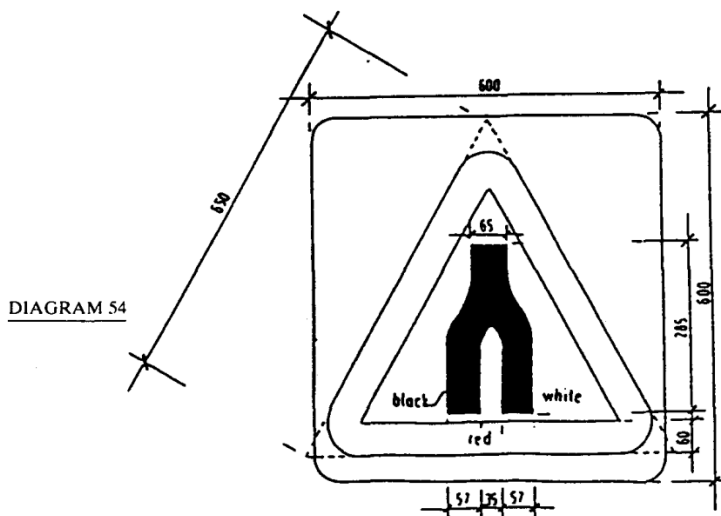

DUAL CARRIAGEWAY ENDS AHEAD

This sign indicates that the dual carriageways will merge into a single carriageway ahead.

THE SCHEDULE — continued

DIAGRAM 55

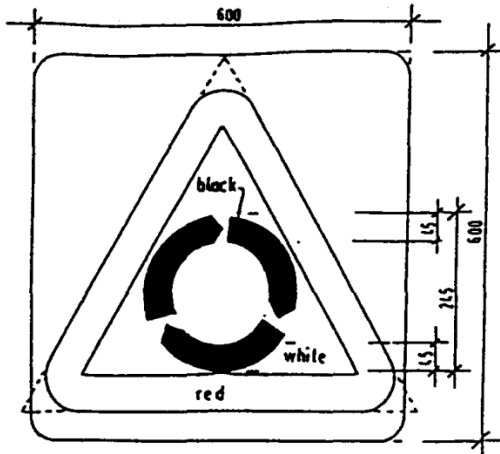

ROUNDBABOUT AHEAD

This sign indicates that there is a roundabout ahead.

DIAGRAM 56

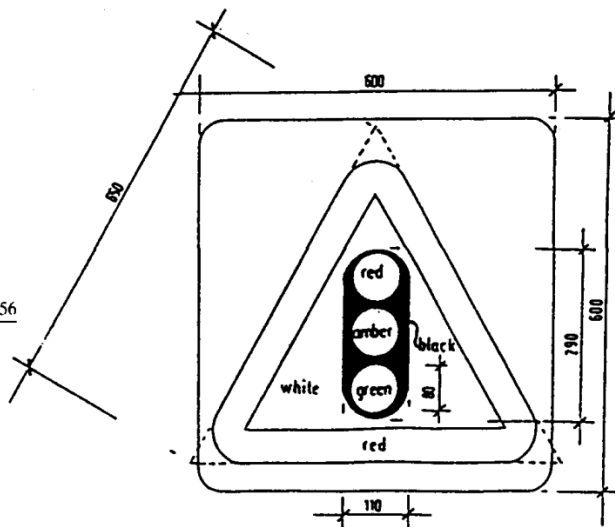

TRAFFIC SIGNALS AHEAD

This sign indicates that traffic is controlled by traffic light signals ahead.

THE SCHEDULE — *continued*

DIAGRAM 57

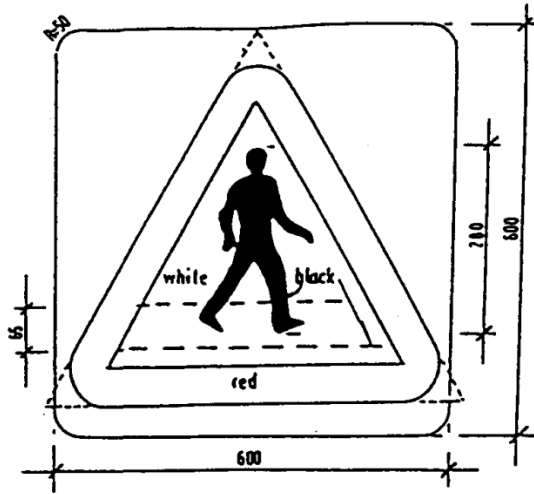

PEDESTRIAN CROSSING AHEAD

This sign indicates that there is a pedestrian crossing ahead.

THE SCHEDULE — continued

DIAGRAM 57 (a)

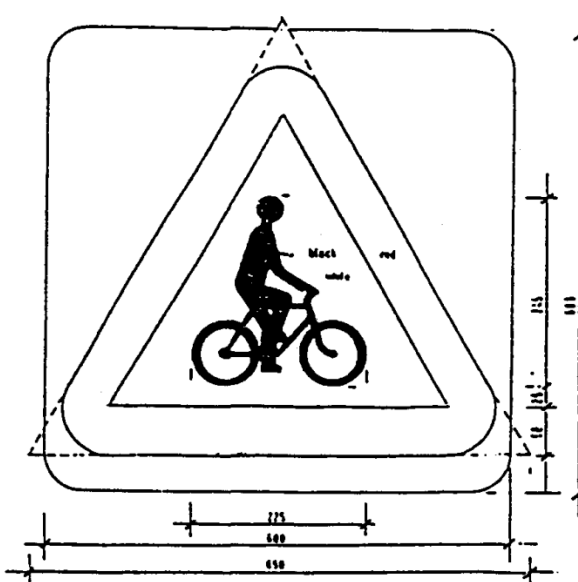
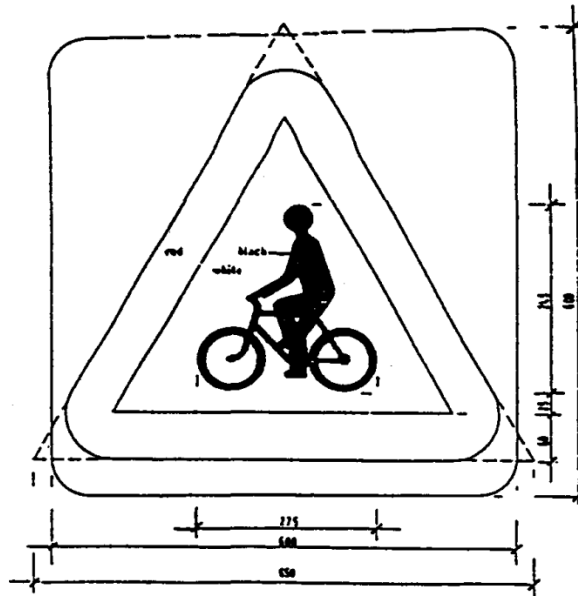

BICYCLE CROSSING AHEAD

This sign indicates that there is a bicycle crossing ahead.

THE SCHEDULE — *continued*

DIAGRAM 57(b)

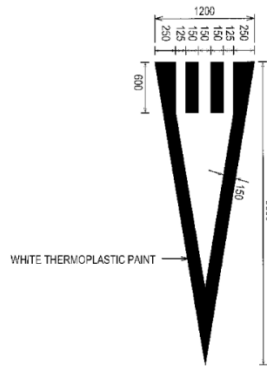

PEDESTRIAN CROSSING AHEAD MARKING

This marking indicates that there is a zebra crossing ahead and motorists should be prepared to give way to pedestrians crossing the road at the zebra crossing.

[S 257/2009 wef 08/06/2009]

DIAGRAM 57(c)

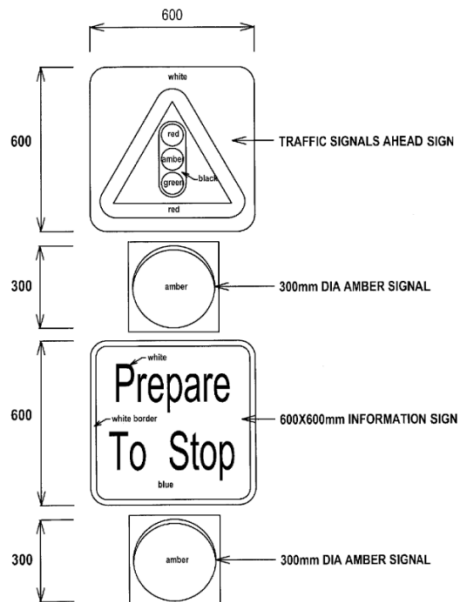

ADVANCED WARNING LIGHTS

THE SCHEDULE — *continued*

The flashing amber lights indicate to motorists that the traffic light signal ahead is red or going to turn red and motorists should slow down and prepare to stop.

[S 257/2009 wef 08/06/2009]

DIAGRAM 57(d)

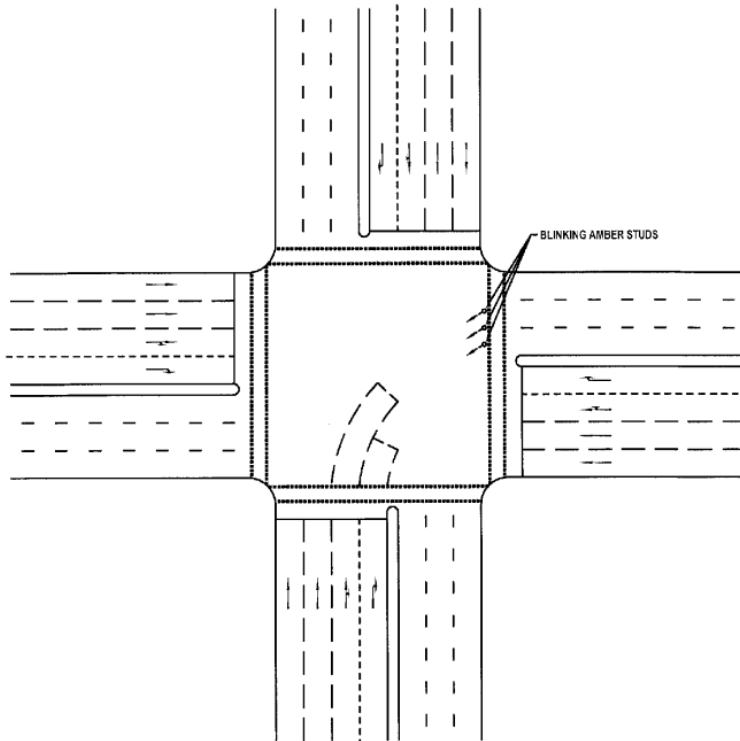

INTELLIGENT ROAD STUDS

These intelligent road studs, mounted flush to the road surface, blink when the green man light of the associated pedestrian crossing is illuminated. They indicate to motorists turning right that they should give way to pedestrians crossing the road.

[S 257/2009 wef 08/06/2009]

THE SCHEDULE — continued

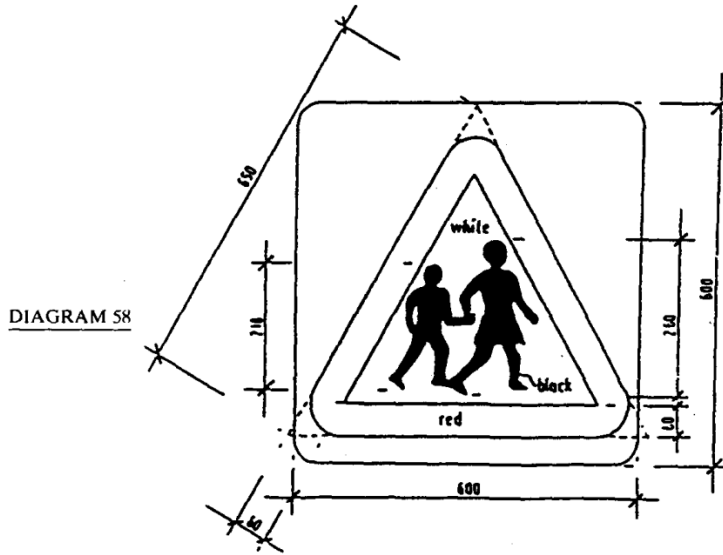

CHILDREN

This sign indicates that there is ahead an area where children are likely to be encountered.

DIAGRAM 58(a)

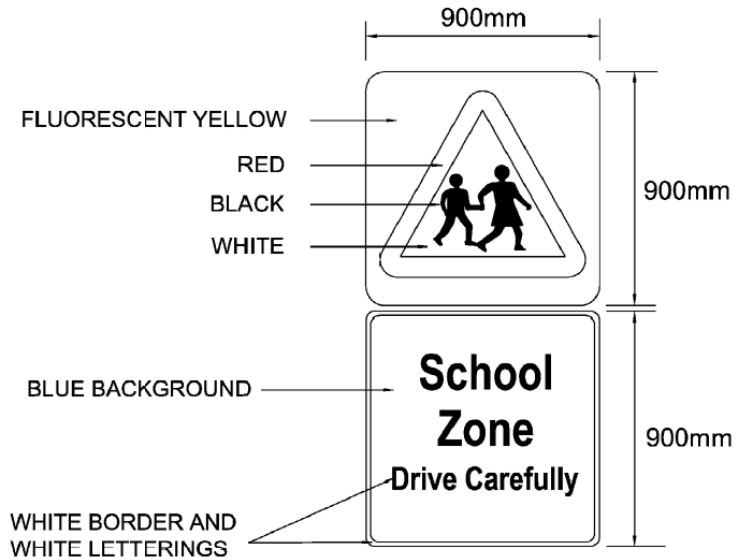

SCHOOL ZONE DRIVE CAREFULLY

THE SCHEDULE — *continued*

This sign is placed at the start of a demarcated school zone.
It indicates that the section of the road ahead fronts a school.

[S 782/2013 wef 01/01/2014]

DIAGRAM 58(b)

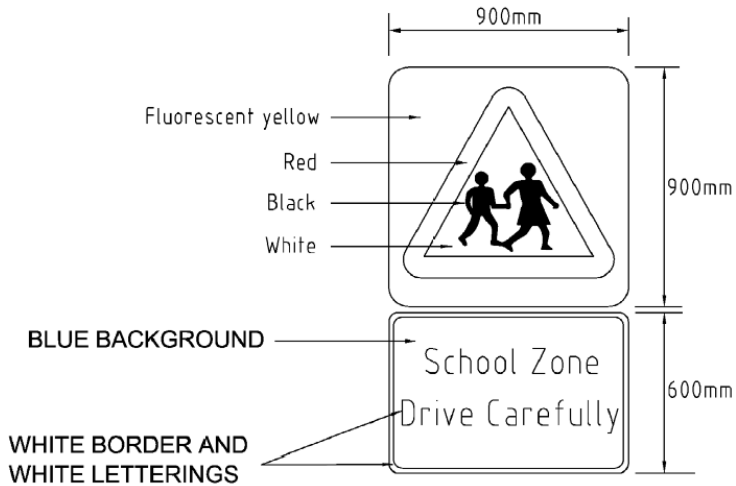

SCHOOL ZONE DRIVE CAREFULLY

This sign is placed at the start of a demarcated school zone.
It indicates that the section of the road ahead fronts a school.

[S 782/2013 wef 01/01/2014]

THE SCHEDULE — continued

DIAGRAM 59

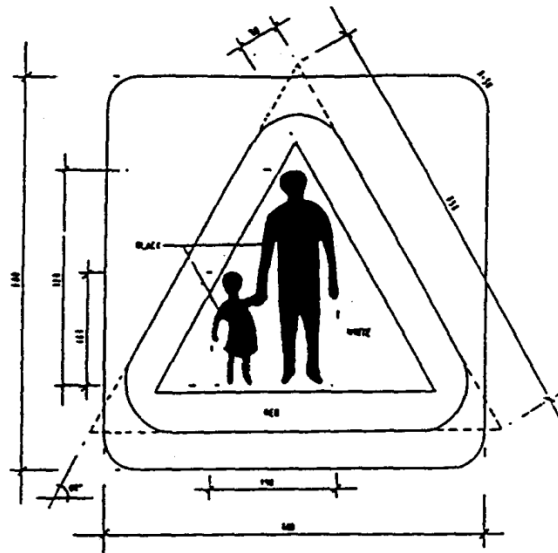

PEDESTRIAN ON ROAD AHEAD

This sign indicates that there is ahead an area where pedestrian are likely to be encountered.

DIAGRAM 60

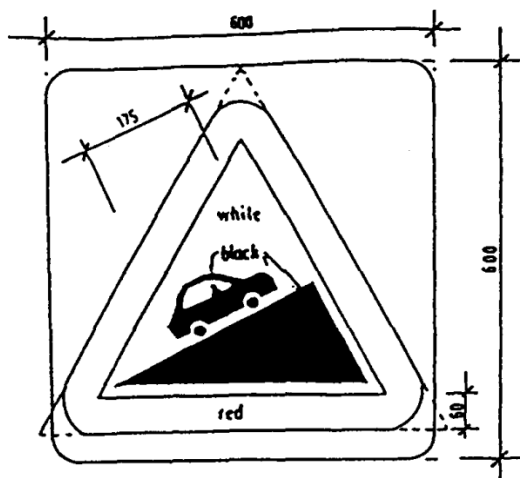

STEEP HILL UPWARDS AHEAD

This sign indicates that there is a steep hill upwards ahead.

THE SCHEDULE — *continued*

DIAGRAM 61

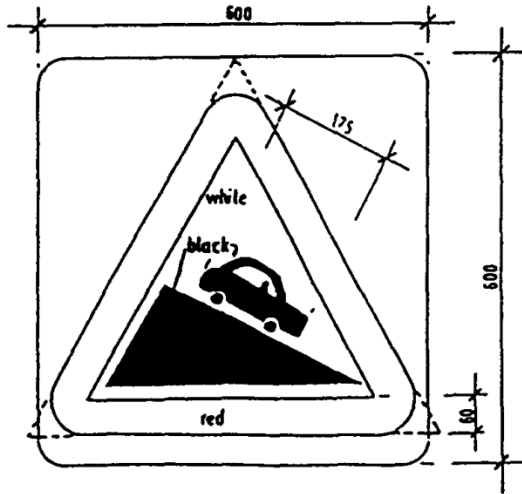

STEEP HILL DOWNWARDS AHEAD

This sign indicates that there is a steep hill downwards ahead.

DIAGRAM 62

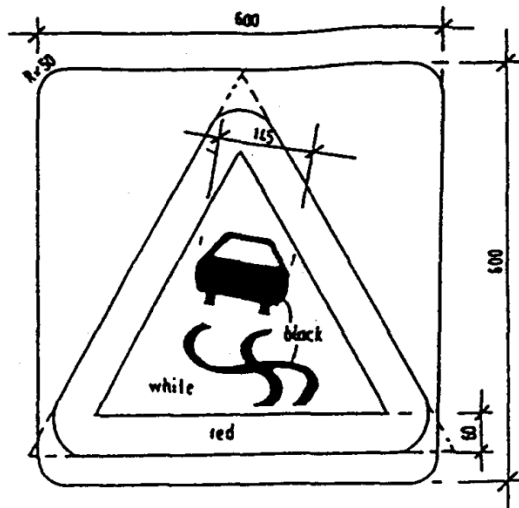

SLIPPERY ROAD AHEAD

This sign indicates that the condition of the road surface ahead is dangerous.

THE SCHEDULE — continued

DIAGRAM 63

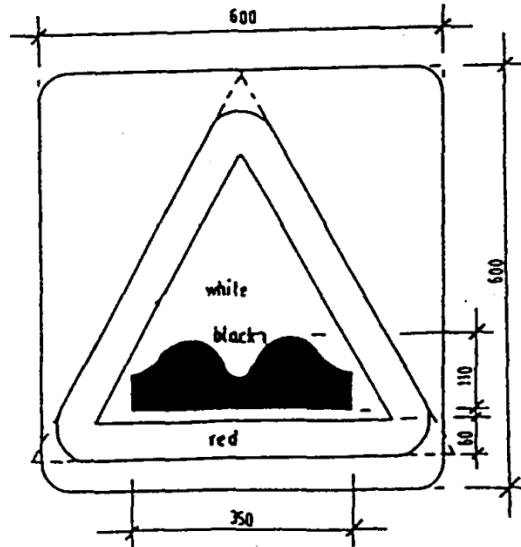

UNEVEN ROAD

This sign indicates that the road ahead is uneven.

DIAGRAM 64

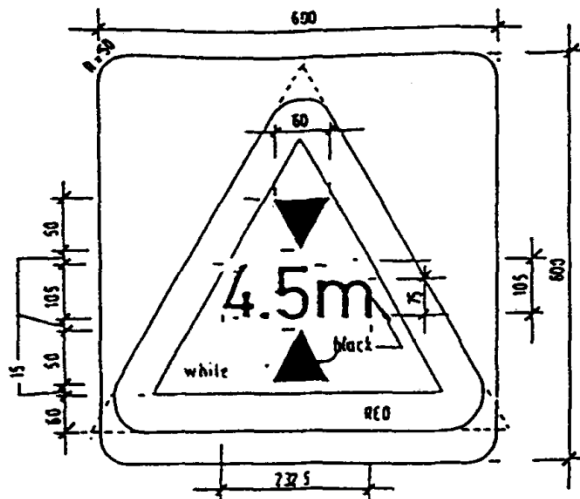

HEIGHT LIMIT AHEAD

This sign indicates that the section of the road ahead has a height restriction of 4.5m. The numerals on the sign may be altered to indicate different height restriction.

THE SCHEDULE — continued

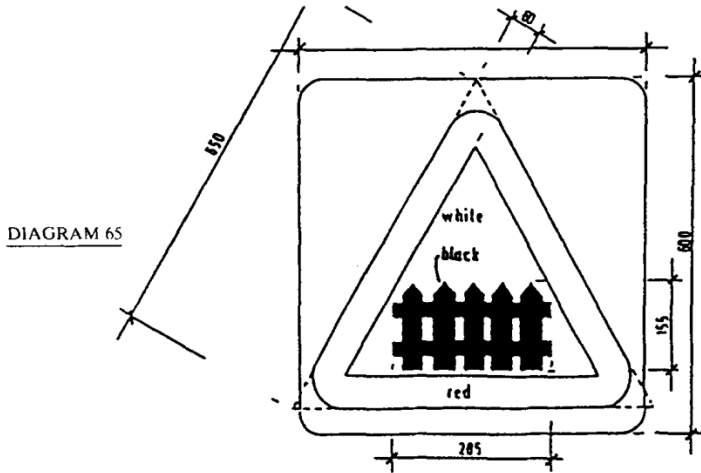

DIAGRAM 65

LEVEL CROSSING WITH GATE OR BARRIER AHEAD

This sign indicates that there is a level crossing with gate or barrier ahead.

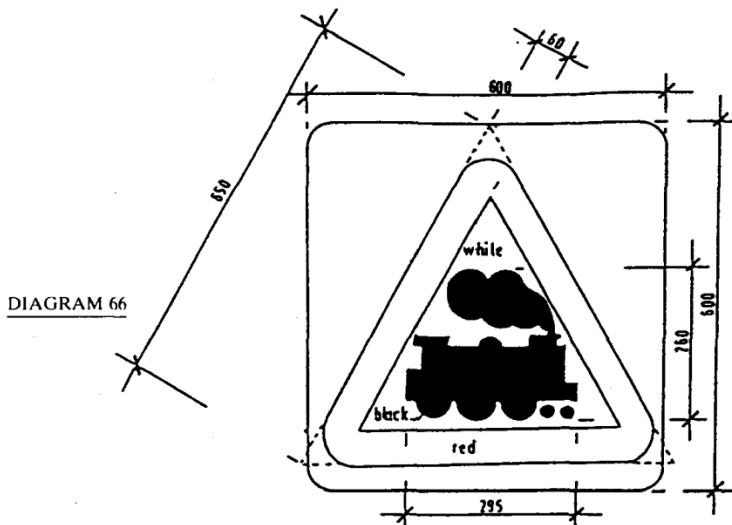

DIAGRAM 66

LEVEL CROSSING WITHOUT GATE OR BARRIER AHEAD

This sign indicates that there is a level crossing without gate or barrier ahead.

THE SCHEDULE — continued

DIAGRAM 67

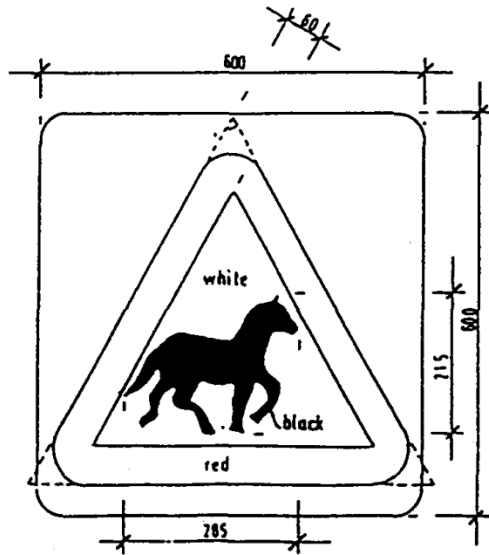

HORSES OR PONIES

This sign indicates that there is ahead an area where horses are likely to be encountered.

DIAGRAM 68

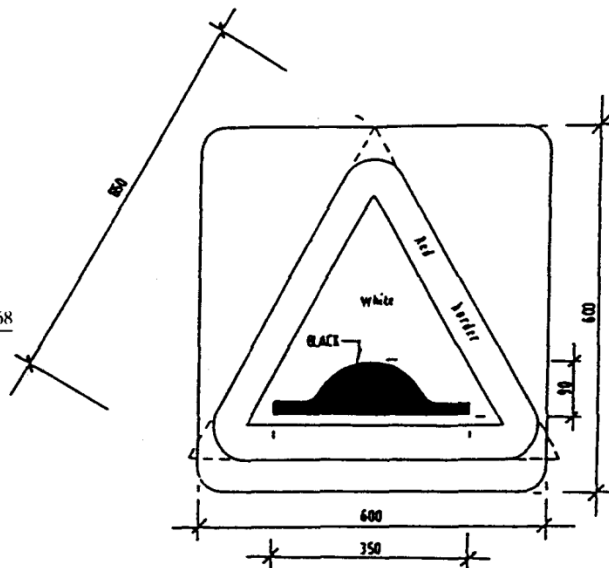

ROAD HUMP AHEAD

This sign indicates that there is a road hump ahead.

THE SCHEDULE — continued

DIAGRAM 69

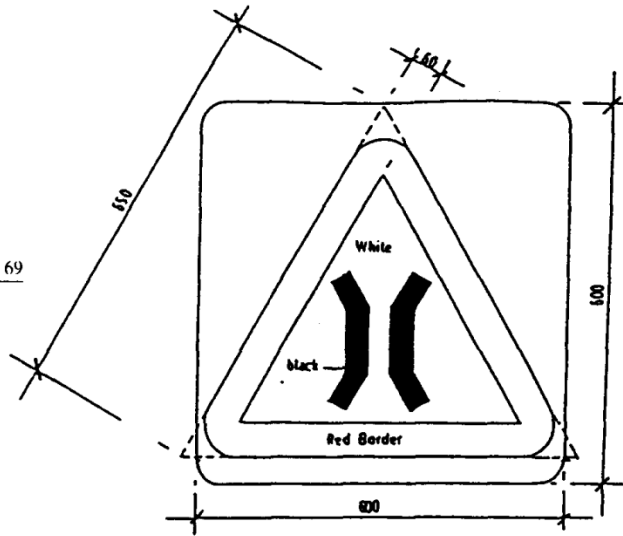

NARROW BRIDGE AHEAD

This sign indicates that there is a narrow bridge ahead.

DIAGRAM 70

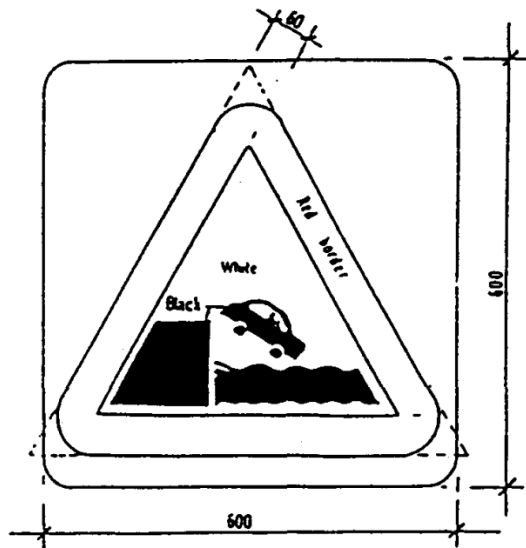

QUAYSIDE OR RIVER BANK AHEAD

This sign indicates that there is a quayside or river bank ahead.

THE SCHEDULE — continued

DIAGRAM 71

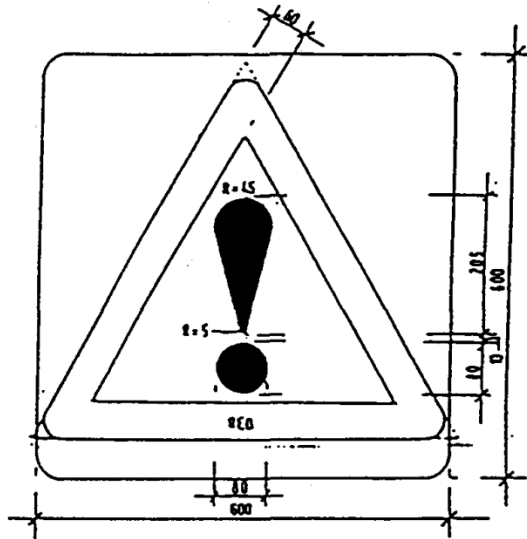

OTHER DANGER

This sign indicates that there is ahead potential danger which is not covered specifically by any other warning sign.

THE SCHEDULE — *continued*

DIAGRAM 72 (a)

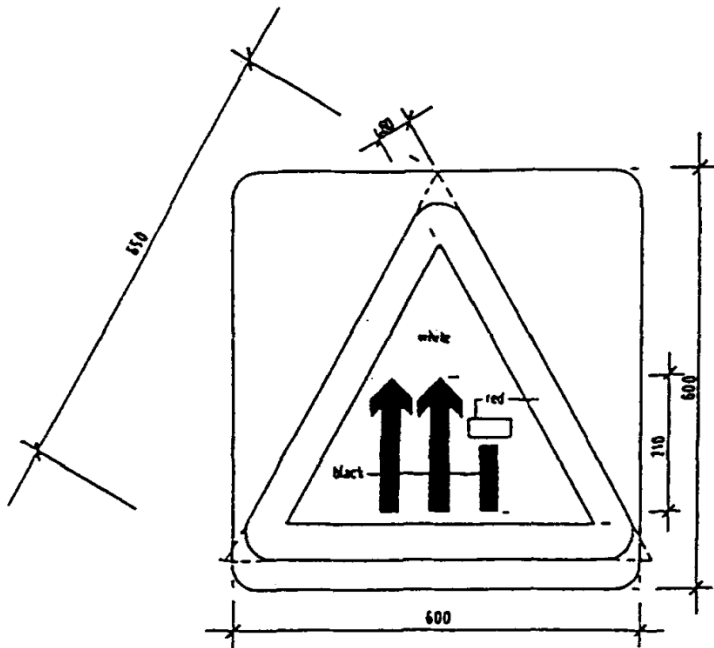

LANE CLOSURE AHEAD
OFFSIDE LANE CLOSED

This symbol may be reversed to indicate —
NEARSIDE LANE CLOSED

This sign indicates that there is ahead closure of the lane marked by the red bar.

THE SCHEDULE — *continued*

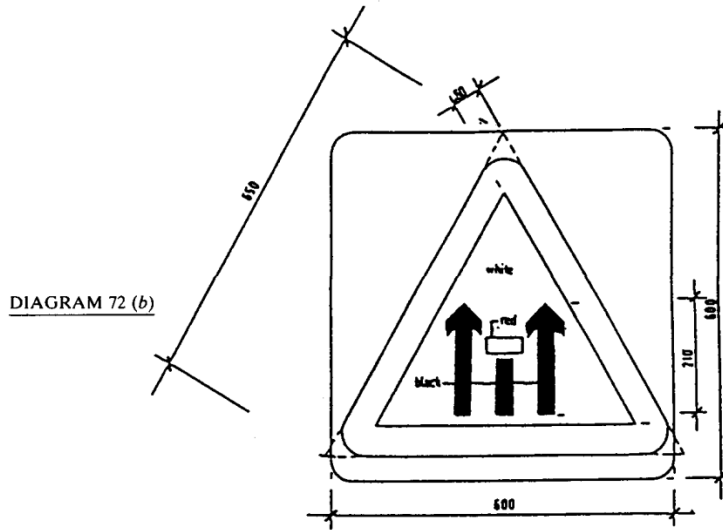

CENTRE LANE CLOSURE AHEAD

This sign indicates that there is ahead closure of the centre lane marked by the red bar.

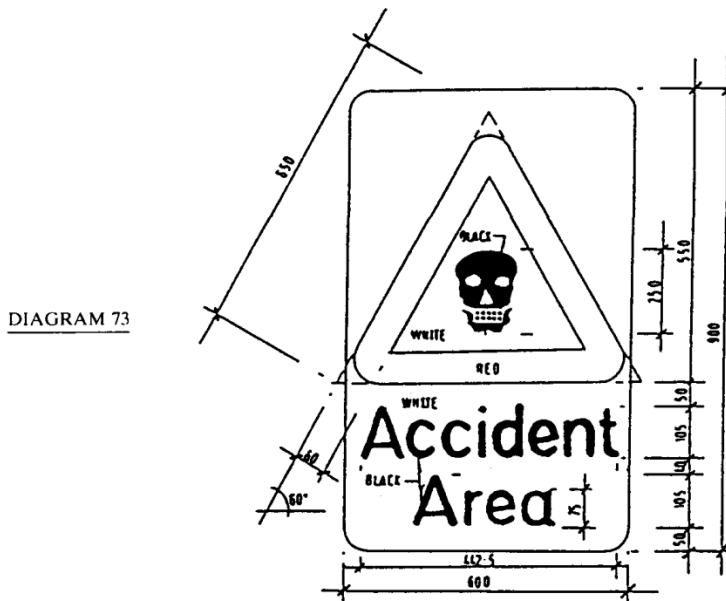

ACCIDENT AREA

This sign indicates the section of the road which is prone to accidents.

THE SCHEDULE — *continued*

DIAGRAM 74

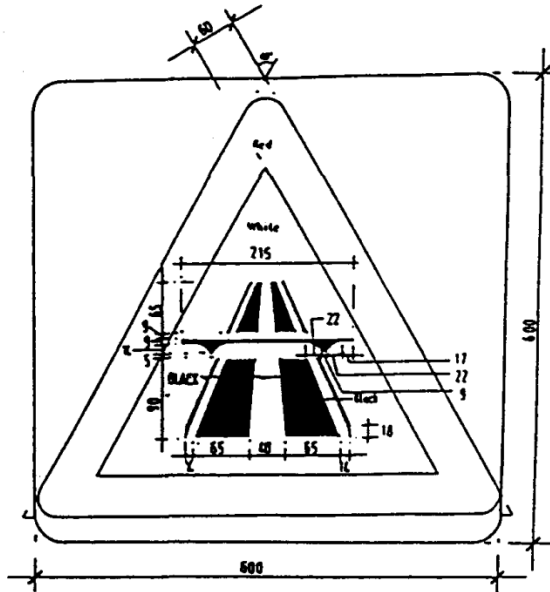

EXPRESSWAY AHEAD

This sign indicates the approach to an expressway.

DIAGRAM 75

RESTRICTED ZONE AHEAD

[Omitted]

DIAGRAM 76

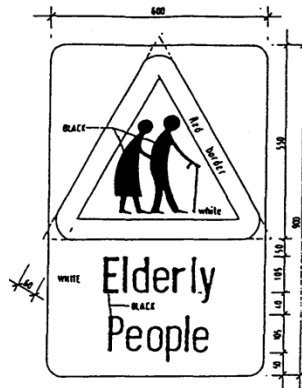

ELDERLY OR HANDICAPPED PEDESTRIANS

THE SCHEDULE — *continued*

This sign indicates that there is ahead an area where elderly or handicapped pedestrians are likely to be encountered.



SILVER ZONE, SLOW DOWN

This sign is placed at the start of a demarcated silver zone. It indicates that elderly pedestrians are likely to be encountered in the section of road ahead and that motorists should slow down.

DIAGRAM 76B



THE SCHEDULE — *continued*

This sign indicates that motorists must keep a lookout for cyclists.

[S 172/2017 wef 22/04/2017]

[S 670/2014 wef 01/10/2014]

DIAGRAM 77

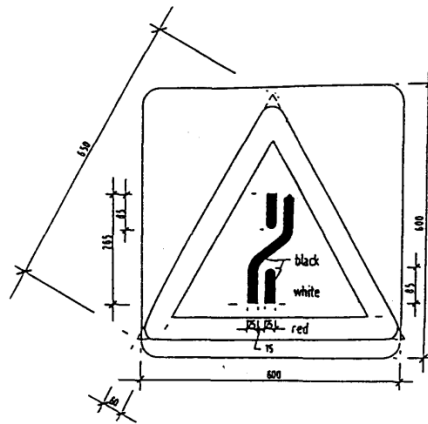

DIVERSION TO ANOTHER CARRIAGEWAY TO THE RIGHT

This symbol may be reversed to indicate —

DIVERSION TO ANOTHER CARRIAGEWAY TO THE LEFT

This sign indicates that there is a diversion of carriageway ahead.

THE SCHEDULE — *continued*

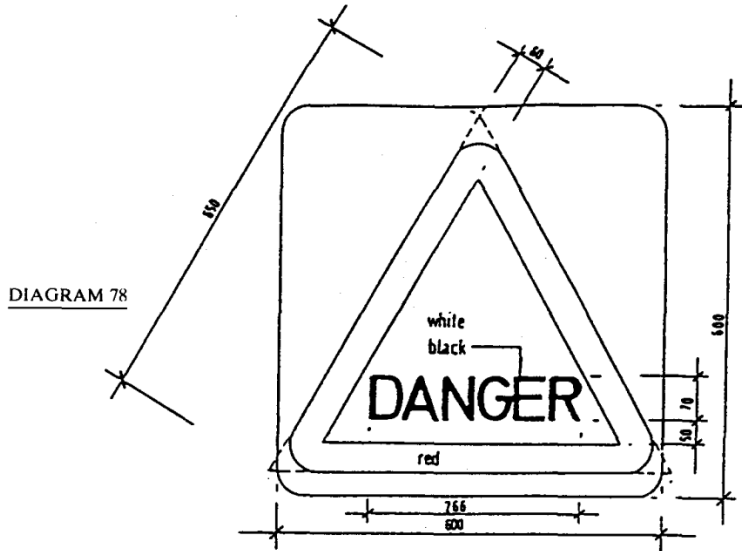

DANGER

This sign indicates an obstruction ahead.

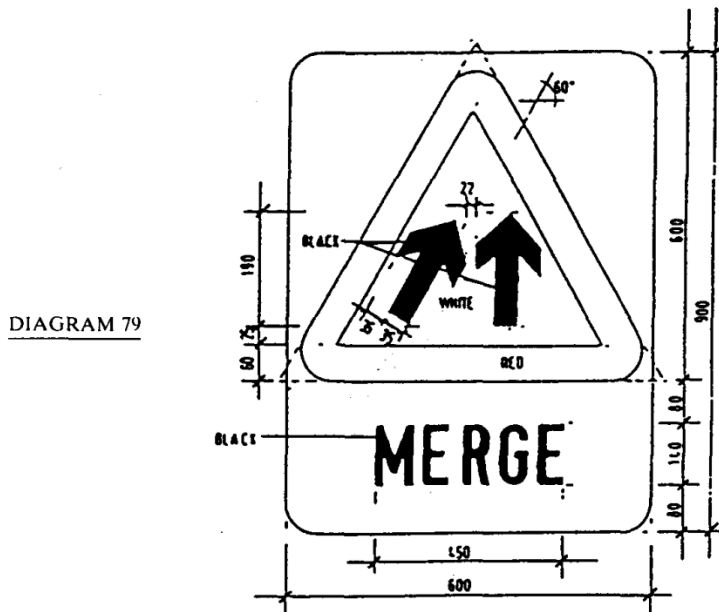

MERGE

This sign indicates that there is a merging of traffic ahead.

THE SCHEDULE — continued

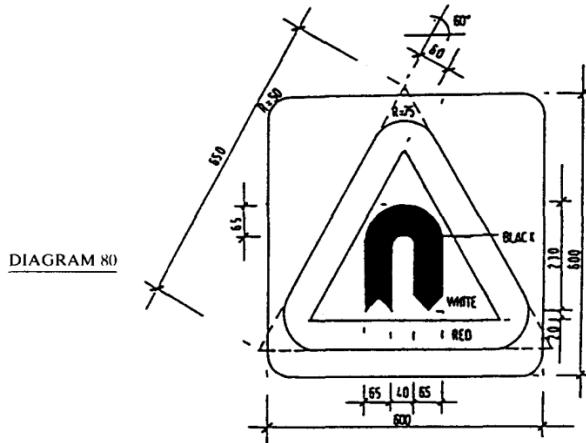

U-TURN AHEAD

This sign indicates that vehicles may be making a U-Turn ahead.

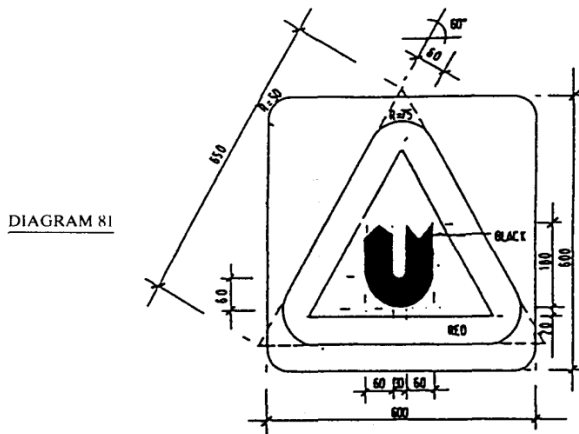

U-TURN AHEAD (FROM OPPOSITE DIRECTION)

This sign indicates that vehicles from the opposite direction may be making a U-Turn ahead.

THE SCHEDULE — continued

DIAGRAM 82



LOW FLYING AIRCRAFT

This sign indicates that there is ahead an area where low flying aircraft crossing the path of the road may possibly be encountered.

THE SCHEDULE — continued

DIAGRAM 83

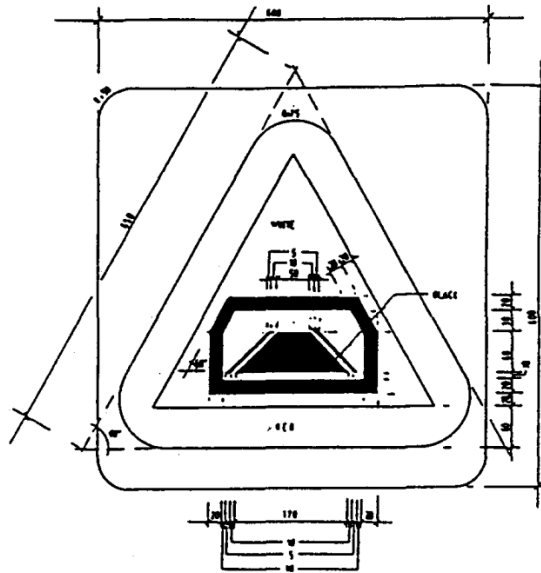

TUNNEL AHEAD

This sign indicates that the stretch of road ahead runs through a tunnel.

DIAGRAM 84

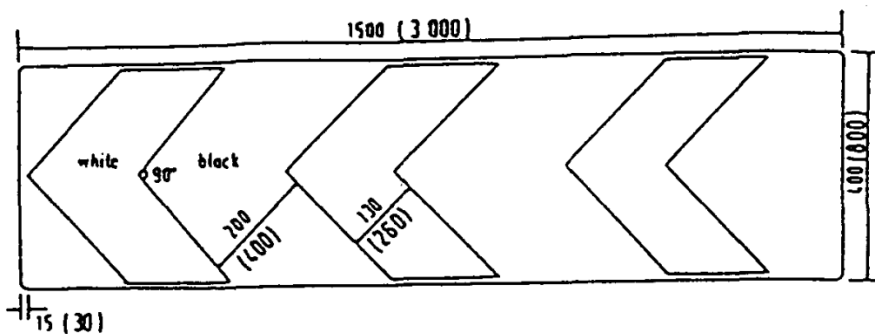

SHARP DEVIATION

This sign indicates that there is a sharp deviation in the road to the left.

THE SCHEDULE — *continued*

DIAGRAM 85

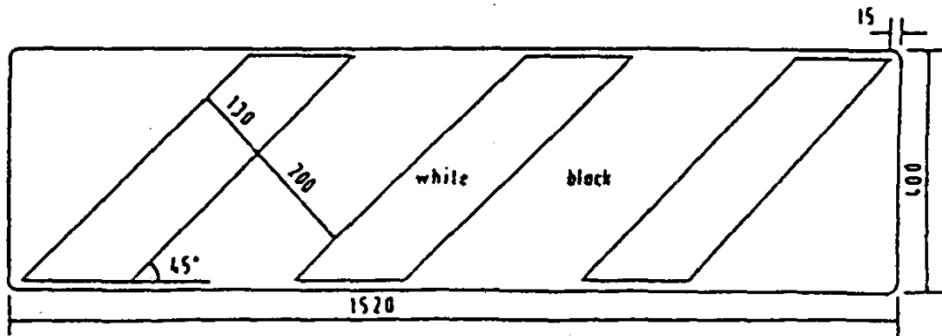

BARRIER

This sign indicates a temporary barrier.

PART III

INFORMATIVE SIGNS

DIAGRAM 86 (a)

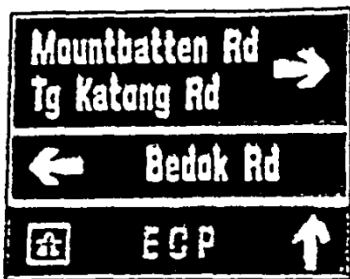
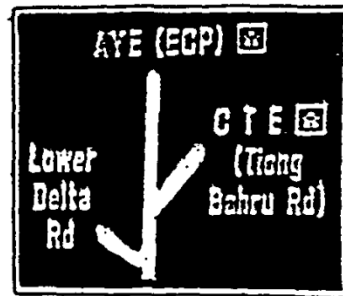

DIAGRAM 86 (b)



ADVANCE DIRECTIONAL SIGNS

DIAGRAM 86 (c)



DIAGRAM 86 (d)

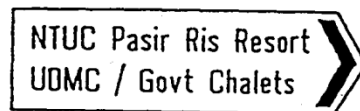

CONFIRMATORY SIGNS

THE SCHEDULE — continued

Note: In diagrams 86(a) to 86(d), the background of the signs may be in green, blue or white. The symbols and inscriptions on a coloured background are in white or yellow and on a white background, in black.

DIAGRAM 86 (e)

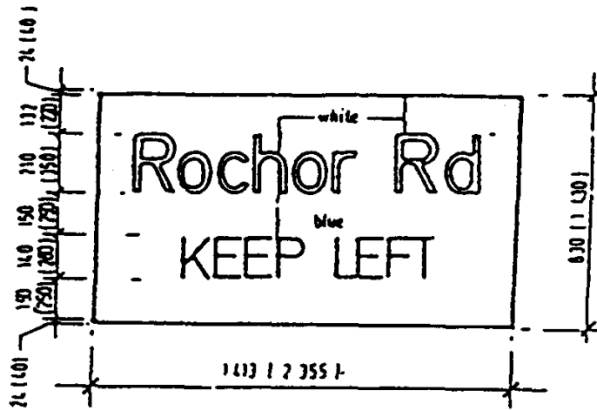

ROCHOR ROAD, KEEP LEFT

DIAGRAM 86 (f)

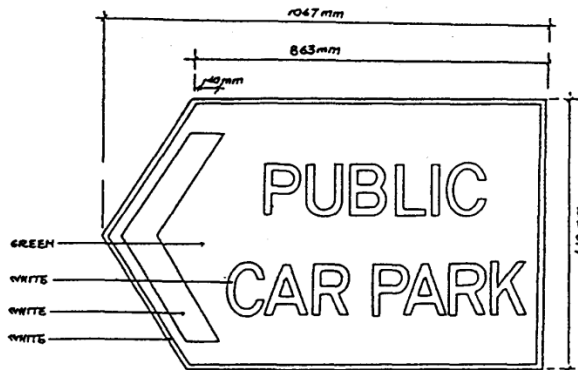

PUBLIC CAR PARK

THE SCHEDULE — *continued*

DIAGRAM 87

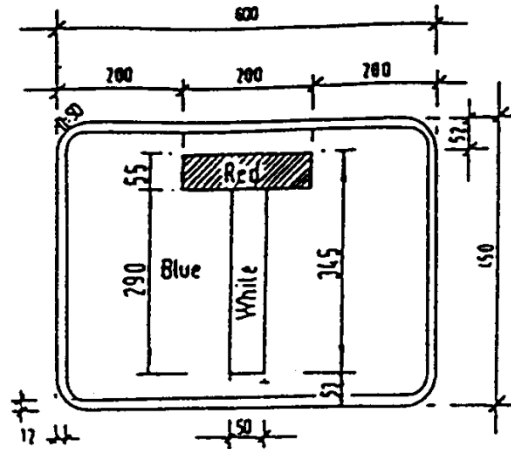

NO THROUGH ROAD

This sign placed at the entry to a road indicates a no through road.

DIAGRAM 88

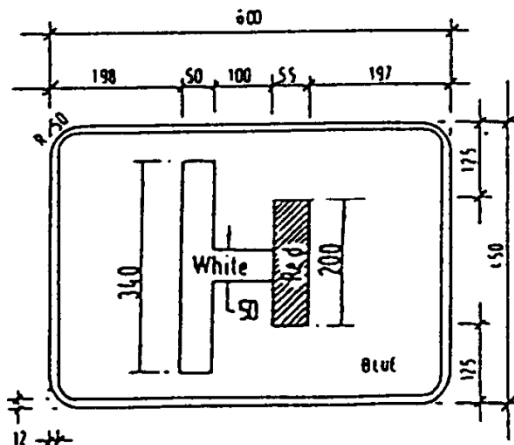

NO THROUGH ROAD ON SIDE ROAD TO THE RIGHT

This symbol may be reversed to indicate —

NO THROUGH ROAD ON SIDE ROAD TO THE LEFT

This sign indicates that the road on the right (or left) is a no through road.

THE SCHEDULE — *continued*

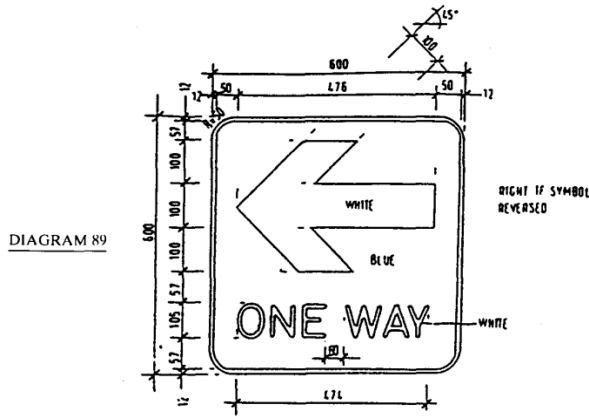

ONE WAY STREET

ONE WAY STREET TO LEFT

The arrow may be reversed to point right to indicate —

ONE WAY STREET TO RIGHT

The above indicates that the traffic flow along the road ahead is a one way to the left (or right).

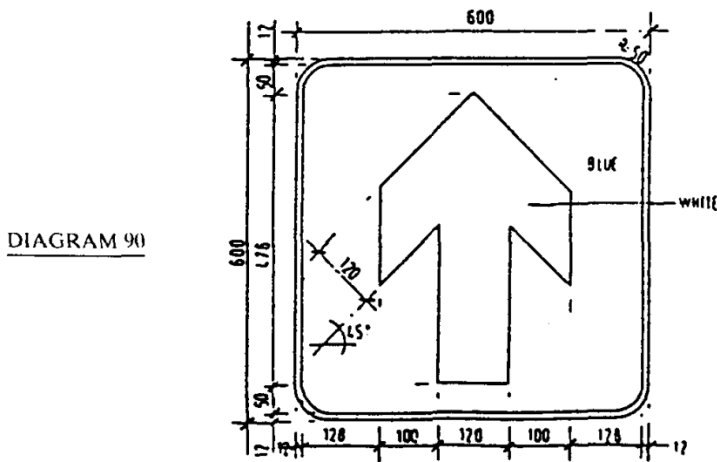

ONE WAY TRAFFIC

This sign indicates the direction of traffic flow on a one way street.

THE SCHEDULE — continued

DIAGRAM 91

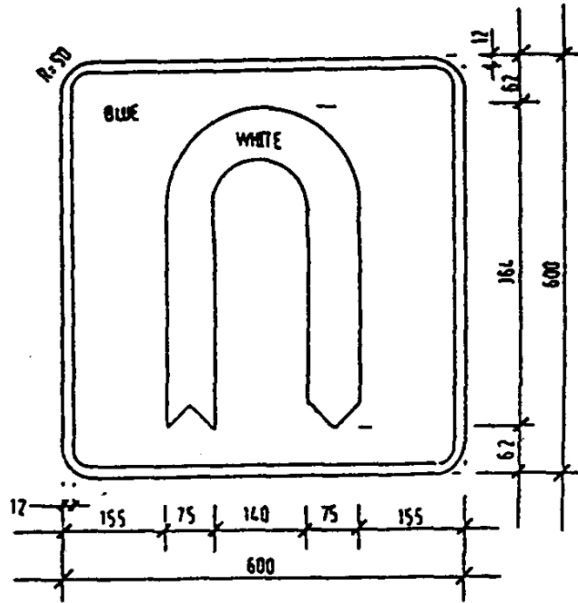

U-TURN

This sign indicates that there is ahead a facility where vehicles are permitted to make a U-Turn.

DIAGRAM 92

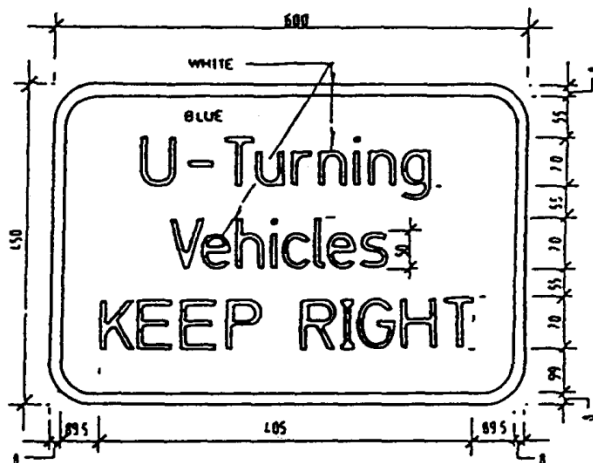

U-TURNING VEHICLES KEEP RIGHT

THE SCHEDULE — *continued*

DIAGRAM 93

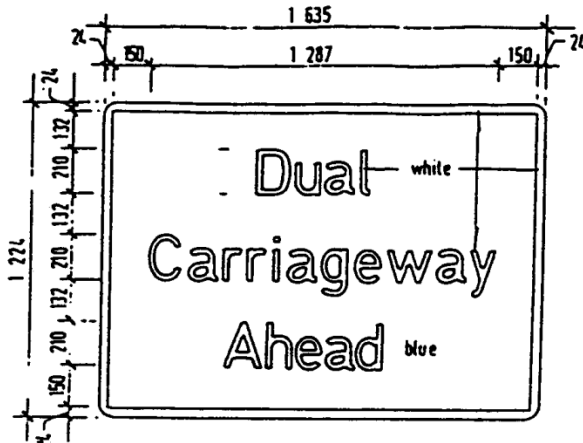

DUAL CARRIAGEWAY AHEAD

DIAGRAM 94

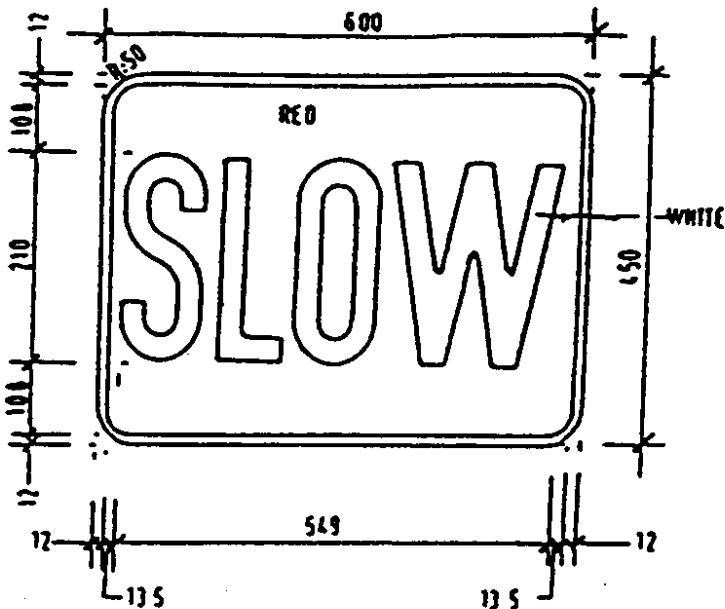

SLOW

THE SCHEDULE — *continued*

DIAGRAM 95

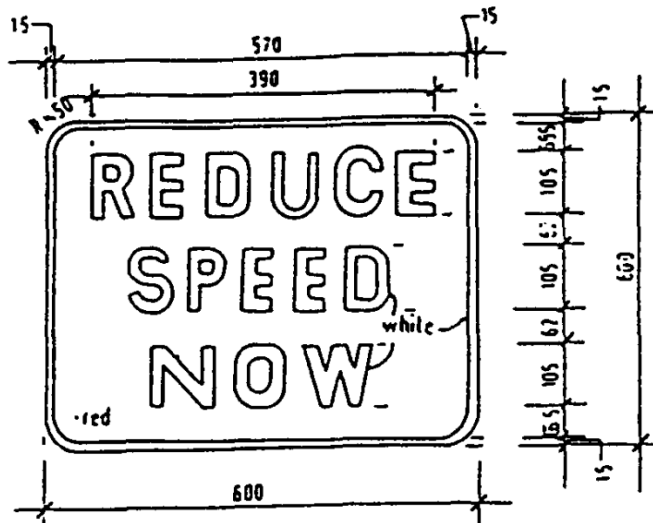

REDUCE SPEED NOW

DIAGRAM 95A

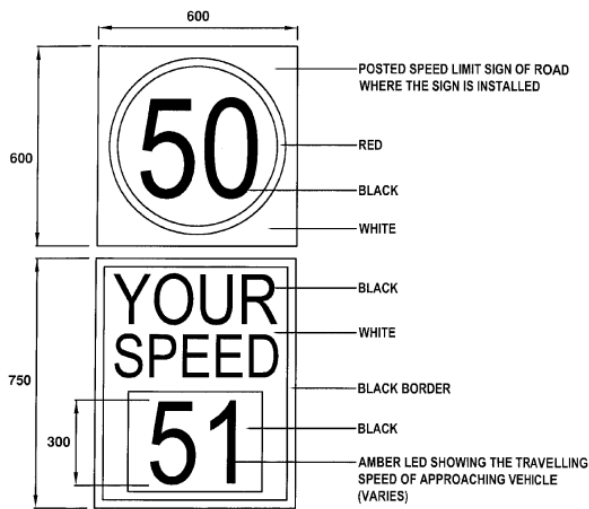

‘YOUR SPEED’ SIGN

The electronic sign will flash a motorist’s real time speed, thereby indicating to the motorist whether he should slow down to obey the speed limit.

[S 257/2009 wef 08/06/2009]

THE SCHEDULE — *continued*

DIAGRAM 96

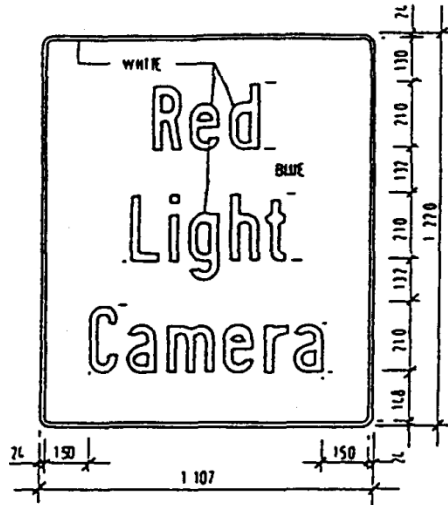

RED LIGHT CAMERA

DIAGRAM 97



KEEP LEFT UNLESS OVERTAKING

THE SCHEDULE — *continued*

DIAGRAM 98

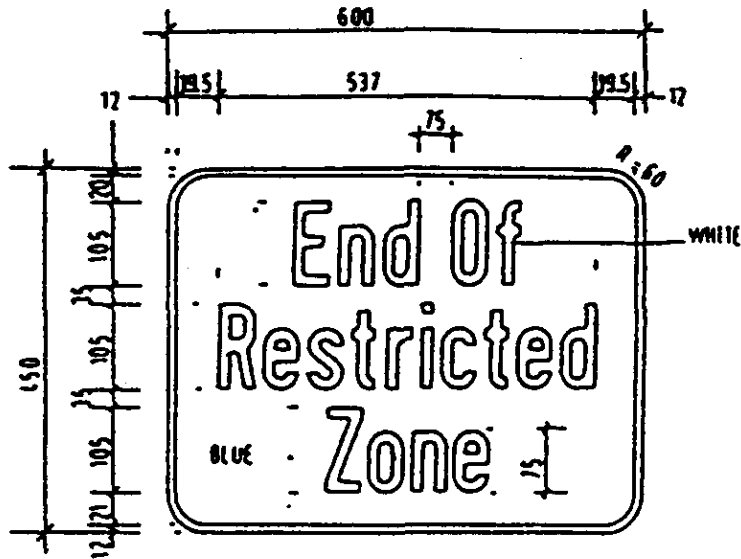

END OF RESTRICTED ZONE

DIAGRAM 99

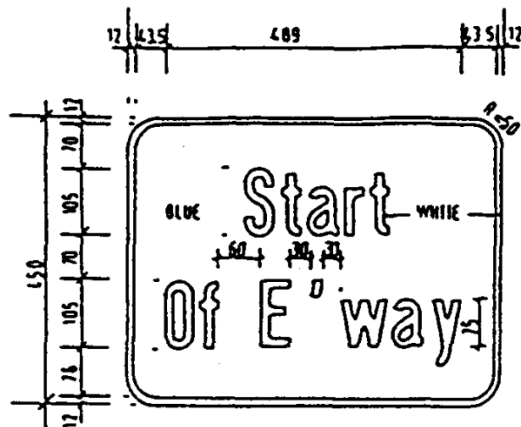

START OF EXPRESSWAY

THE SCHEDULE — *continued*

DIAGRAM 100

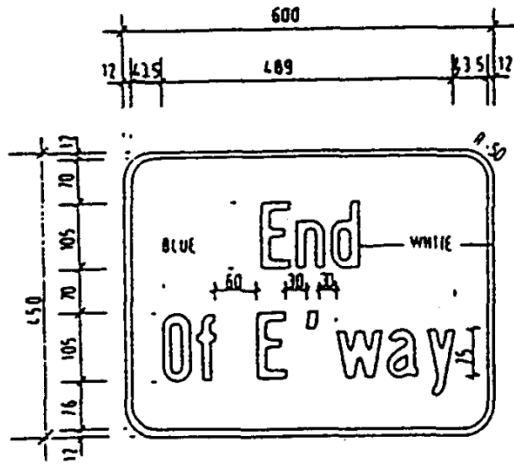

END OF EXPRESSWAY

DIAGRAM 101

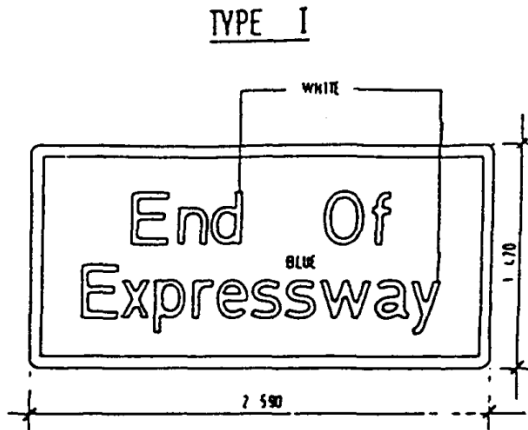

END OF EXPRESSWAY

THE SCHEDULE — continued

DIAGRAM 102

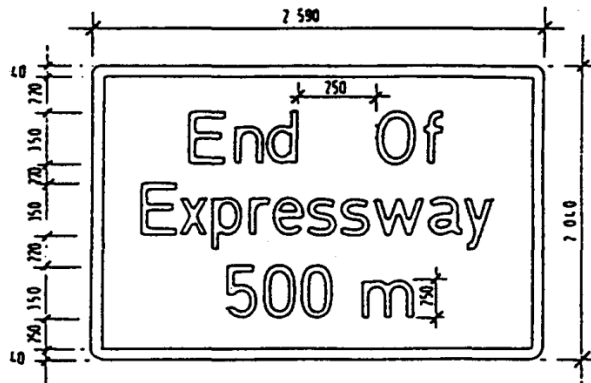

END OF EXPRESSWAY AHEAD

DIAGRAM 103

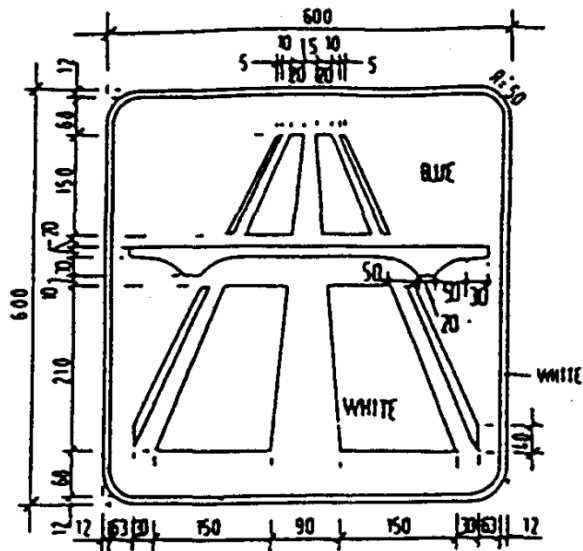

START OF EXPRESSWAY

This sign indicates the start of an expressway.

THE SCHEDULE — *continued*

DIAGRAM 104

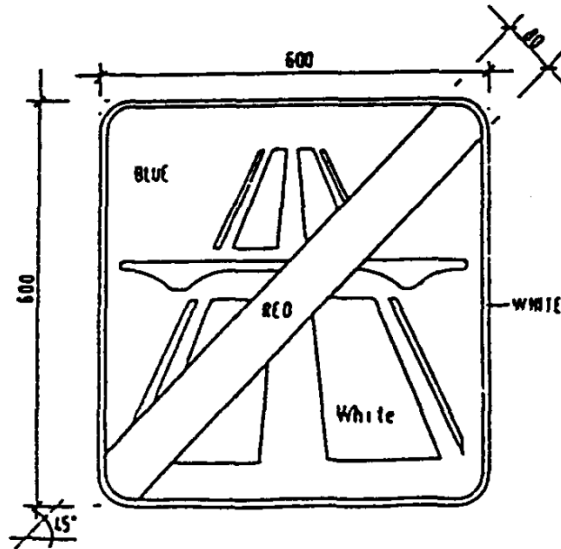

END OF EXPRESSWAY

This sign indicates the end of an expressway.

THE SCHEDULE — *continued*

DIAGRAM 105

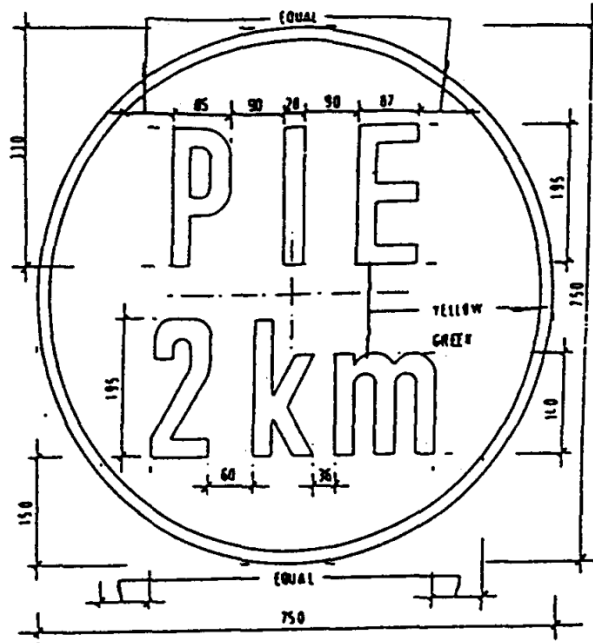
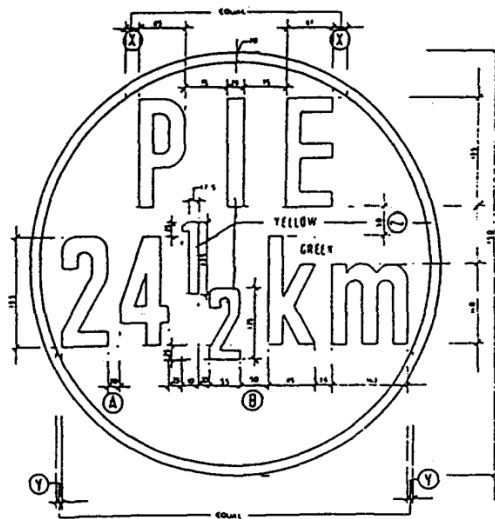

DIAGRAM 106



EXPRESSWAY KILOMETRE SIGN

Diagram 107(a)

[Deleted by S 538/2011 wef 21/09/2011]

THE SCHEDULE — *continued*

Diagram 107(b)

[Deleted by S 538/2011 wef 21/09/2011]

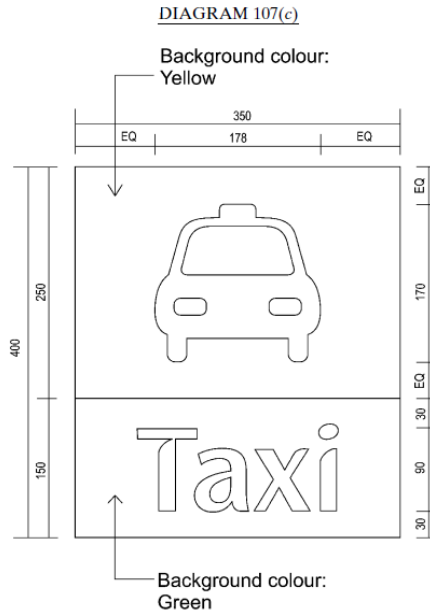

TAXI STOP

This sign indicates the location of a taxi stop.

[S 165/2011 wef 29/03/2011]

THE SCHEDULE — *continued*

DIAGRAM 107(d)

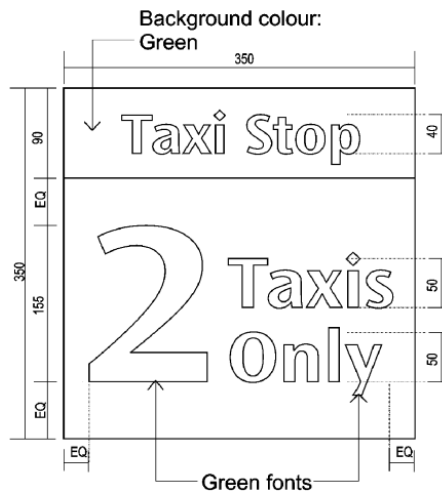

TAXI STOP

This sign indicates the specified number of taxis that may use the taxi stop at any one time.

[S 165/2011 wef 29/03/2011]

Diagram 108

[Deleted by S 538/2011 wef 21/09/2011]

Diagram 108A

[Deleted by S 538/2011 wef 21/09/2011]

THE SCHEDULE — *continued*

DIAGRAM 108B

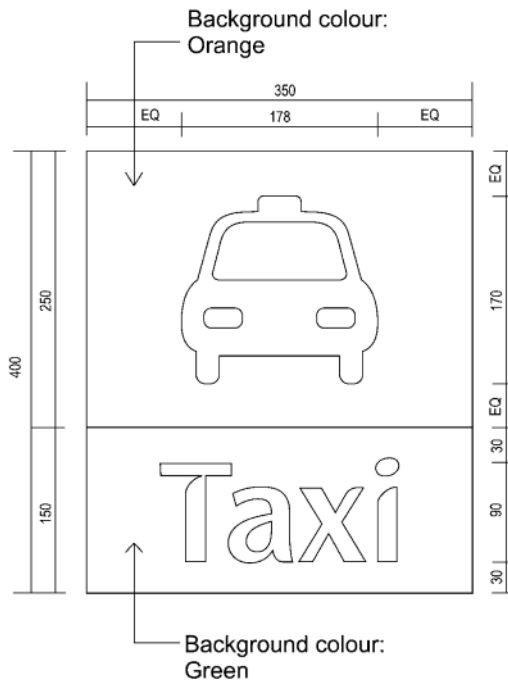

TAXI STAND

This sign indicates the location of a taxi stand.

[S 165/2011 wef 29/03/2011]

THE SCHEDULE — *continued*

DIAGRAM 108C

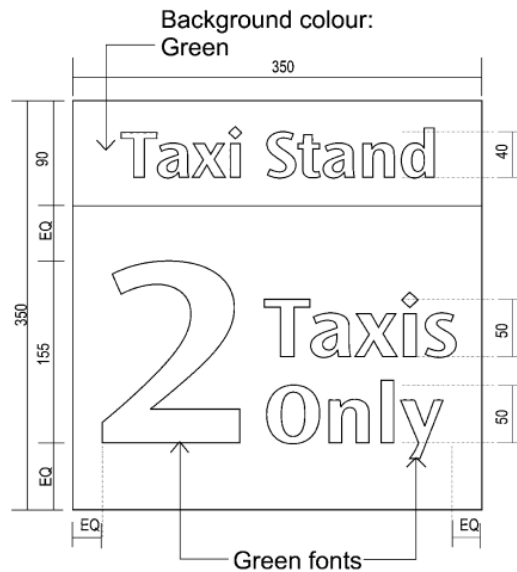

TAXI STAND

This sign indicates the specified number of taxis that may use the taxi stand at any one time.

[S 165/2011 wef 29/03/2011]

DIAGRAM 109

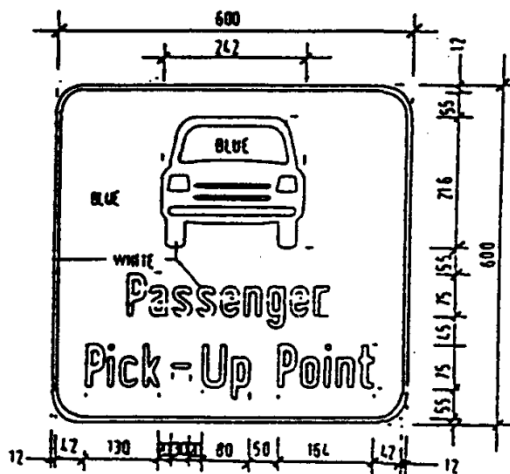

PASSENGER PICK-UP POINT

THE SCHEDULE — *continued*

Diagram 110

[Deleted by S 538/2011 wef 21/09/2011]

DIAGRAM 110A

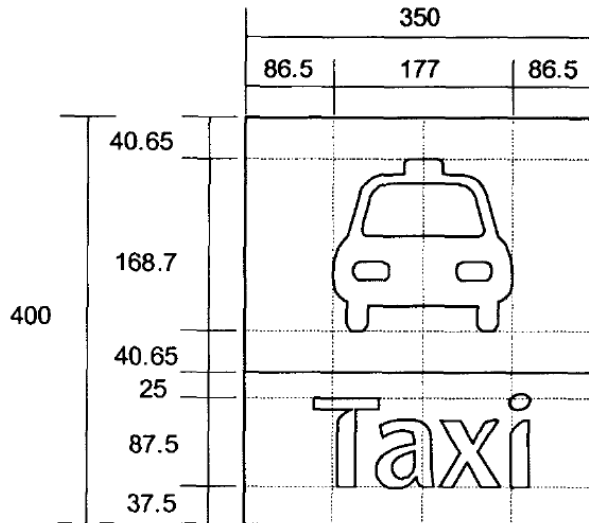

TAXI DROP-OFF POINT

This sign indicates the location of a taxi drop-off point.

[S 375/2001 wef 03/08/2001]

Diagram 111

[Deleted by S 538/2011 wef 21/09/2011]

THE SCHEDULE — *continued*

DIAGRAM 111A



TAXI ADVISORY

This sign informs passengers that it is illegal for taxi drivers to tout or overcharge.

[S 165/2011 wef 29/03/2011]

DIAGRAM 112

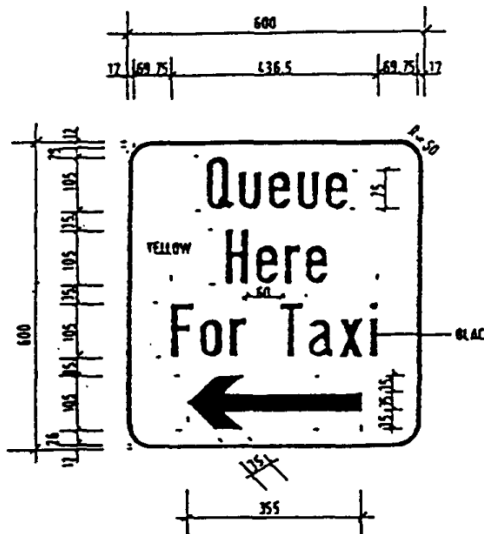

QUEUE HERE FOR TAXI

THE SCHEDULE — *continued*

DIAGRAM 113

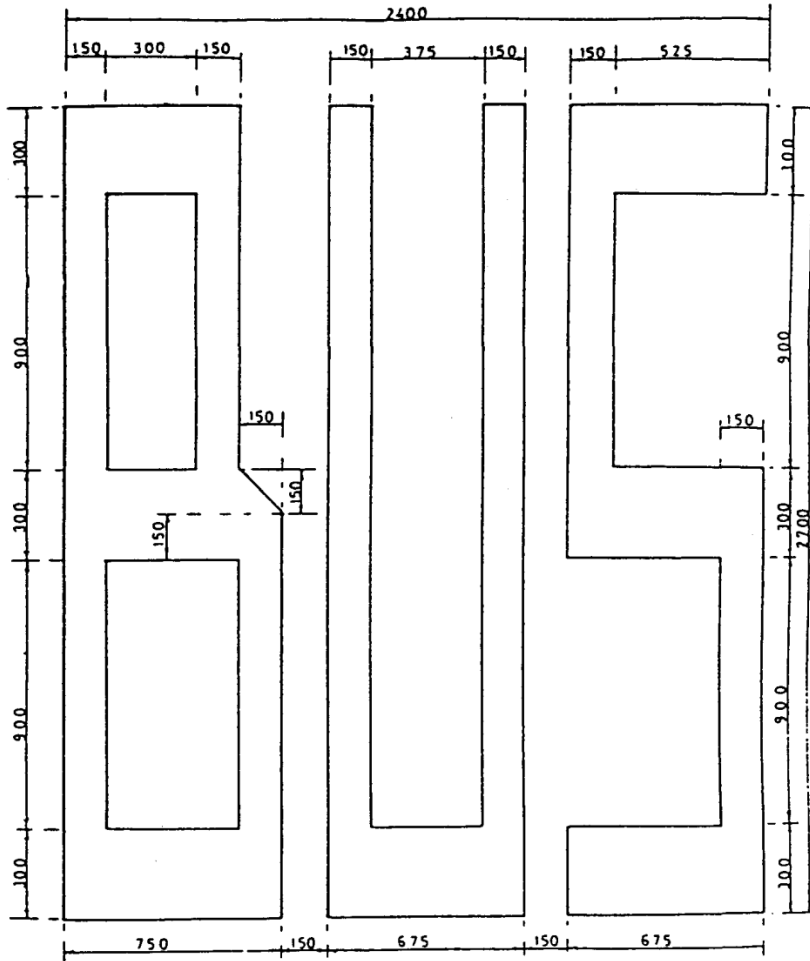

MARKING AT THE START OF A PART-DAY AND FULL-DAY BUS LANE

[S 639/2005 wef 03/10/2005]

THE SCHEDULE — *continued*

DIAGRAM 114



PART-DAY BUS LANE

[S 134/2007 wef 01/04/2007]

THE SCHEDULE — *continued*

DIAGRAM 114A



FULL-DAY BUS LANE

[S 114/2016 wef 21/03/2016]

[S 134/2007 wef 01/04/2007]

DIAGRAM 115 (a)

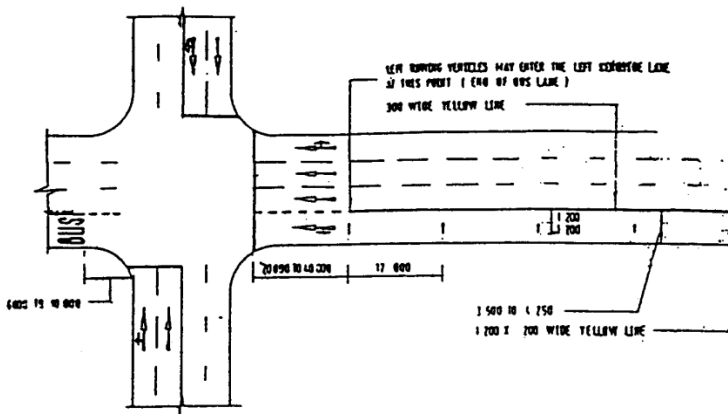

THE SCHEDULE — *continued*

AT SIGNALISED INTERSECTION FOR PART-DAY BUS LANE

[S 639/2005 wef 03/10/2005]

DIAGRAM 115 (b)

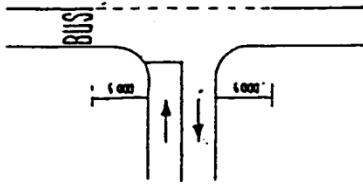

DIAGRAM 115 (c)

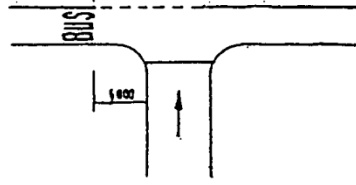
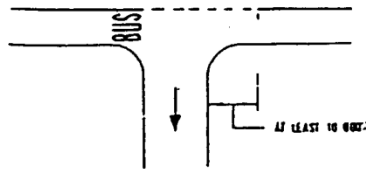

DIAGRAM 115 (d)



AT UNCONTROLLED JUNCTIONS
OR OPENINGS

PART-DAY BUS LANE MARKINGS

[S 639/2005 wef 03/10/2005]

DIAGRAM 115 (e)

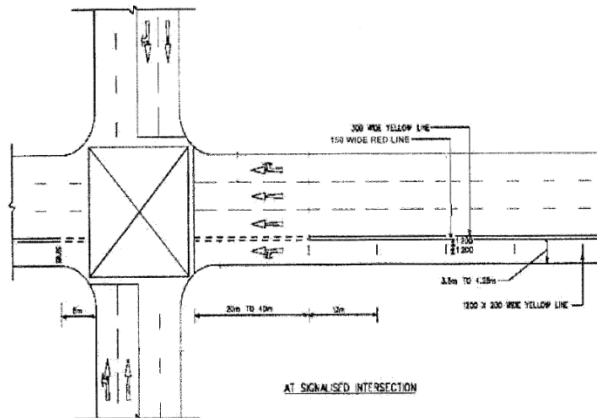

AT SIGNALISED INTERSECTION

THE SCHEDULE — *continued*

AT SIGNALISED INTERSECTION FOR FULL-DAY BUS LANE

[S 639/2005 *wef* 03/10/2005]

DIAGRAM 115 (f)

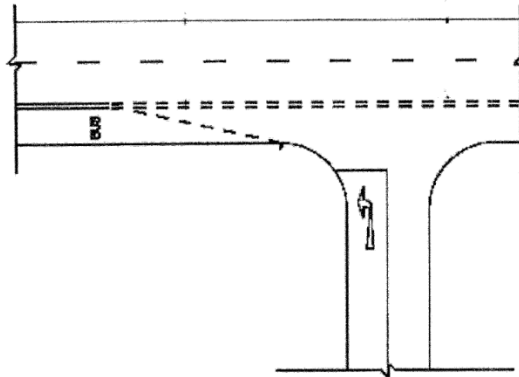

[S 639/2005 *wef* 03/10/2005]

DIAGRAM 115 (g)

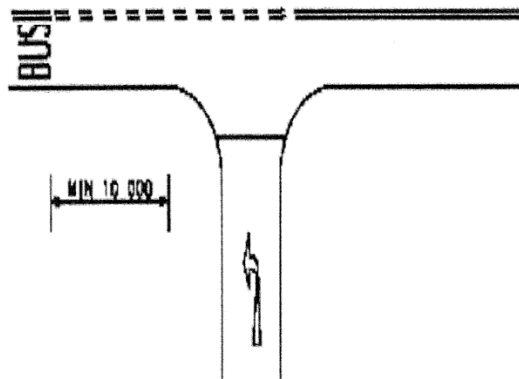

[S 639/2005 *wef* 03/10/2005]

DIAGRAM 115 (h)

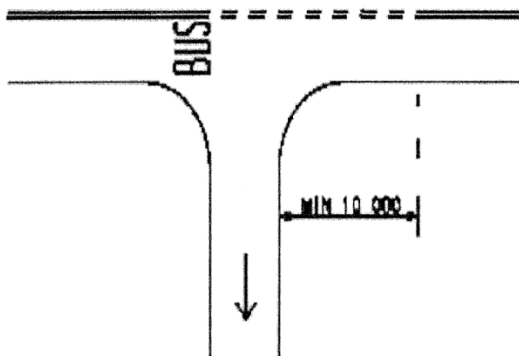

THE SCHEDULE — continued

AT UNCONTROLLED JUNCTIONS OR OPENINGS
FULL-DAY BUS LANE MARKINGS

[S 639/2005 wef 03/10/2005]

DIAGRAM 116 (a)

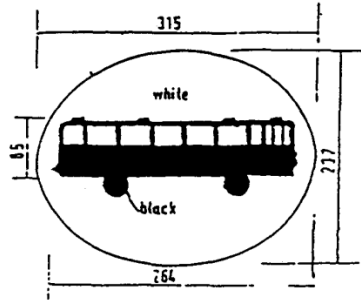

BUS STOP

This sign indicates the location of bus stop.

DIAGRAM 116(aa)

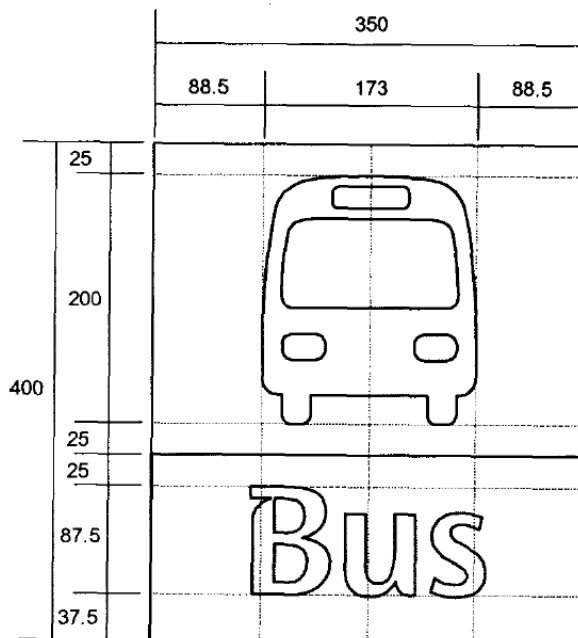

BUS STOP

THE SCHEDULE — *continued*

This sign indicates the location of a bus stop.

[S 375/2001 wef 03/08/2001]

DIAGRAM 116 (b)

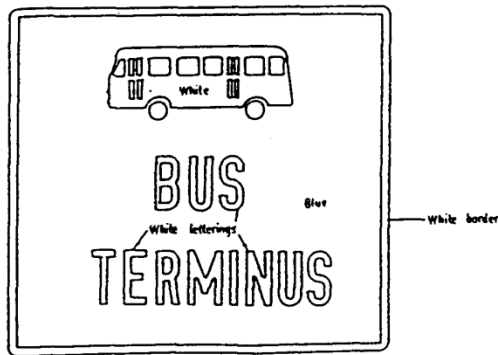

This sign indicates the location of bus terminus.

DIAGRAM 116 (c)

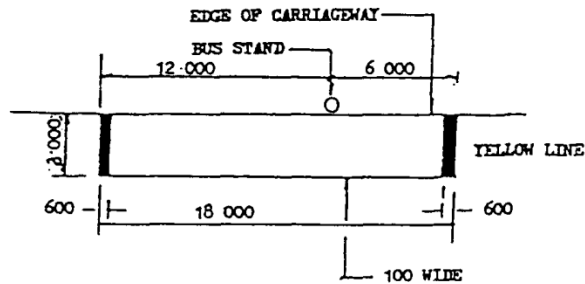

BUS ZONE

The markings indicate a bus zone box reserved for an omnibus to pick up or set down passengers.

THE SCHEDULE — *continued*

DIAGRAM 116(d)

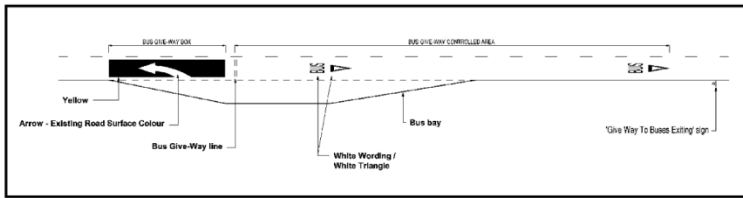

MARKINGS FOR A BUS GIVE-WAY CONTROLLED AREA, BUS GIVE-WAY LINE AND BUS GIVE-WAY BOX

[S 651/2008 wef 20/12/2008]

DIAGRAM 117

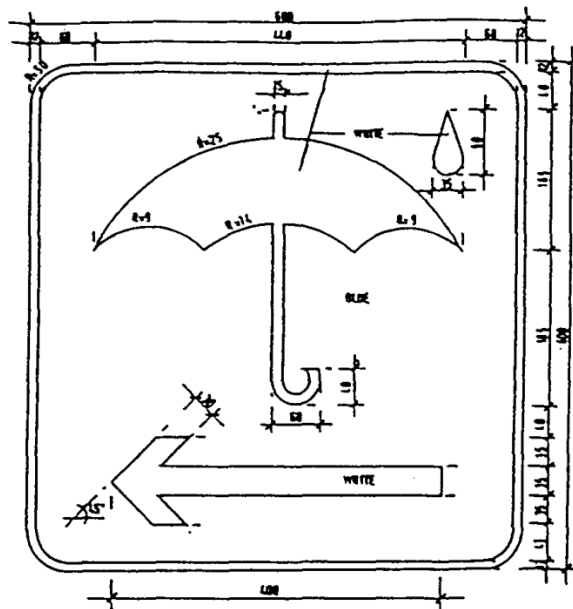

RAIN SHELTER

This sign indicates the location of rain shelter.

THE SCHEDULE — *continued*

DIAGRAM 118

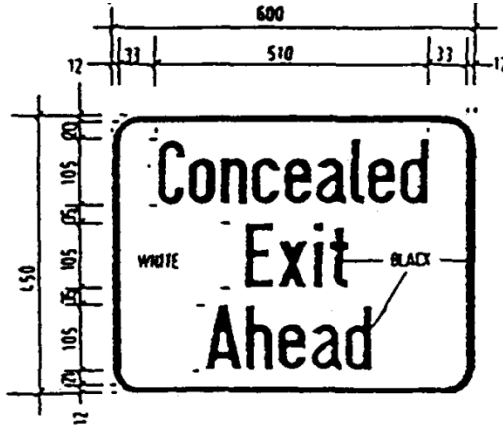

CONCEALED EXIT AHEAD

DIAGRAM 119

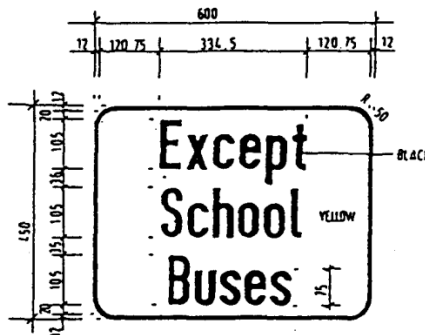

EXCEPT SCHOOL BUSES

DIAGRAM 120

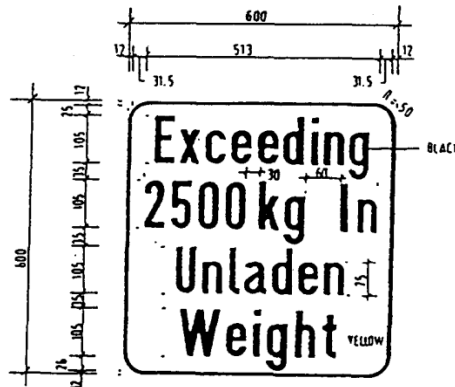

EXCEEDING 2,500 KG IN UNLADEN WEIGHT

THE SCHEDULE — *continued*

DIAGRAM 121

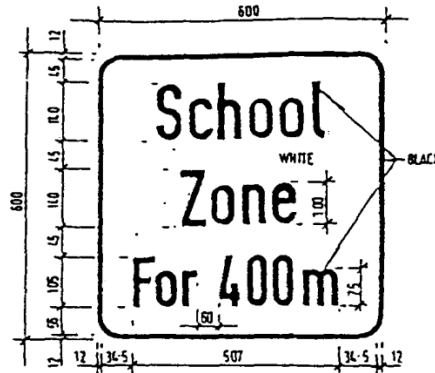

DIAGRAM 122

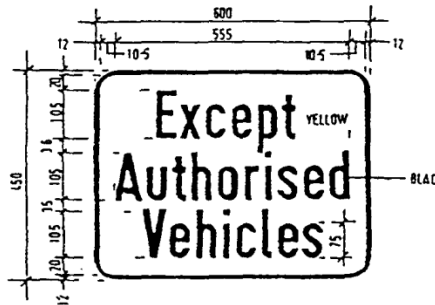
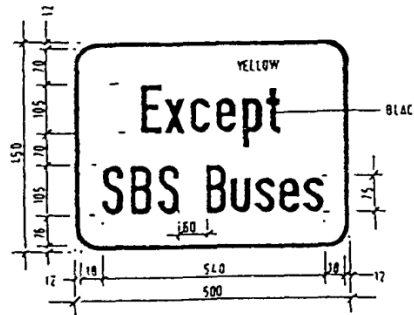
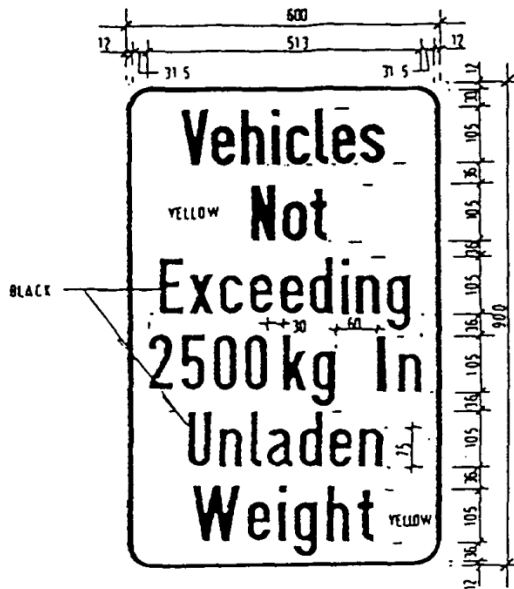

DIAGRAM 123



THE SCHEDULE — *continued*

DIAGRAM 124



VEHICLES NOT EXCEEDING 2,500 KG IN UNLADEN WEIGHT

DIAGRAM 125 (a)

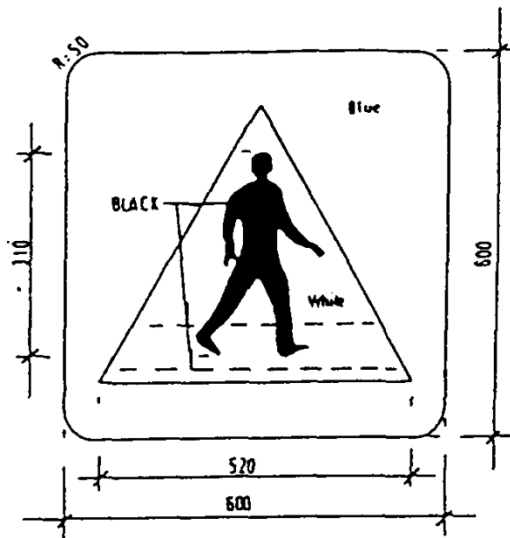

PEDESTRIAN CROSSING

This sign indicates the location of a pedestrian crossing.

THE SCHEDULE — *continued*

DIAGRAM 126

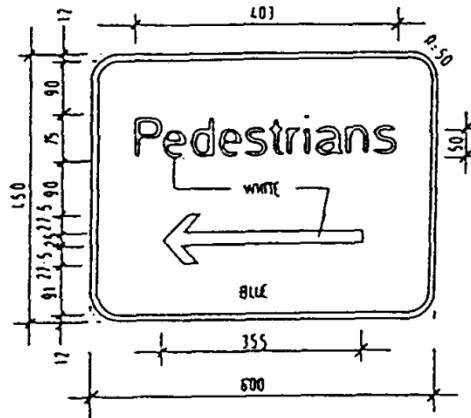

DIRECTION OF TEMPORARY PEDESTRIAN ROUTE

This sign indicates that there is a temporary footway for pedestrian to the left. The arrow may be reversed or a double headed arrow may be used to indicate a temporary footway for pedestrian to the right or to the left and right respectively.

DIAGRAM 127

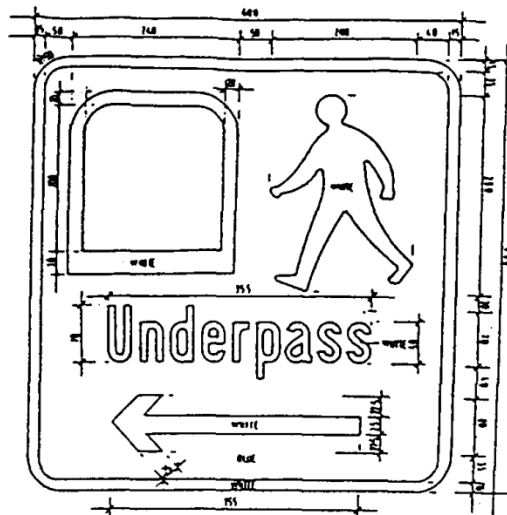

UNDERPASS

This sign indicates the location of a pedestrian underpass.

THE SCHEDULE — *continued*

DIAGRAM 128

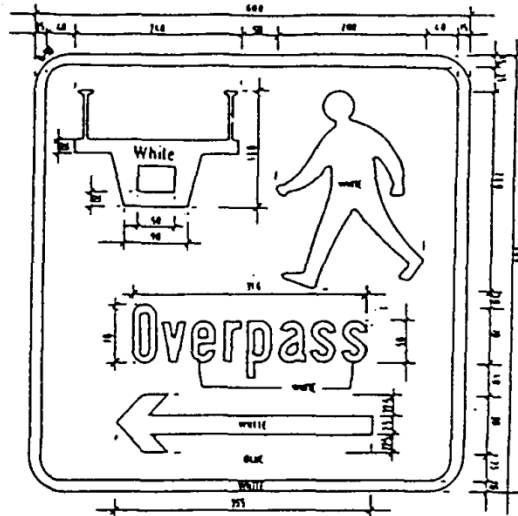

OVERPASS

This sign indicates the location of a pedestrian overpass.

DIAGRAM 129 (a)

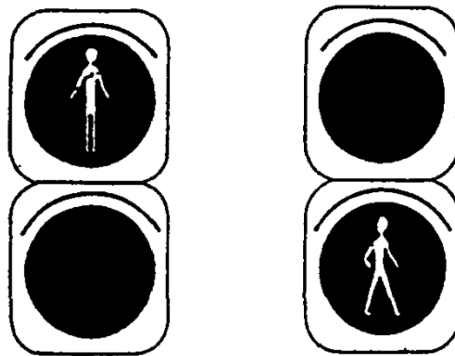

RED MAN

GREEN MAN

LIGHT SIGNALS FOR PEDESTRIANS

THE SCHEDULE — *continued*

DIAGRAM 129 (b)

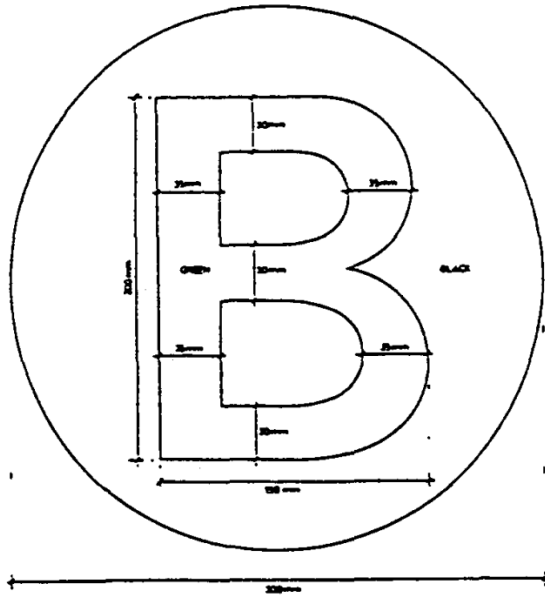

GREEN LIGHT SIGNAL FOR OMNIBUSES

DIAGRAM 129 (c)

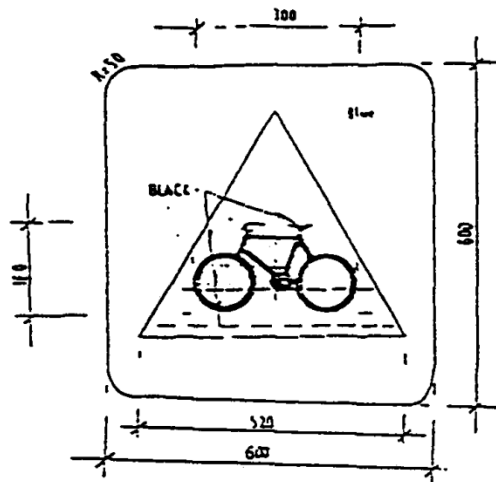

BICYCLE CROSSING

This sign indicates the location of a bicycle crossing.

THE SCHEDULE — *continued*

DIAGRAM 129 (d)

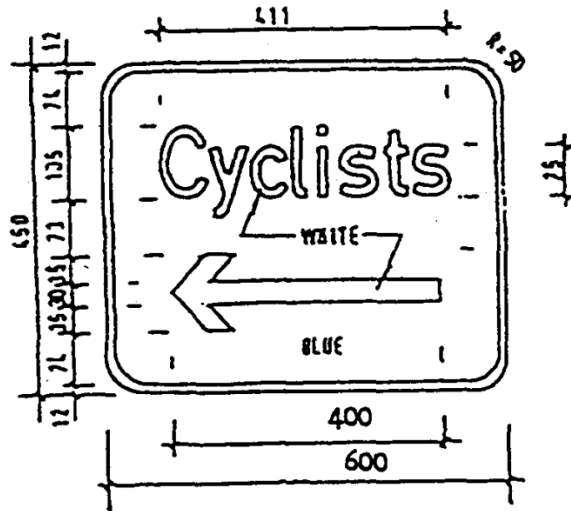

DIRECTION OF TEMPORARY CYCLIST ROUTE

This sign indicates that there is a temporary pathway for cyclist to the left. The arrow may be reversed or a double headed arrow may be used to indicate a temporary footway for cyclist to the right or to the left and right respectively.

THE SCHEDULE — *continued*

DIAGRAM 129 (e)

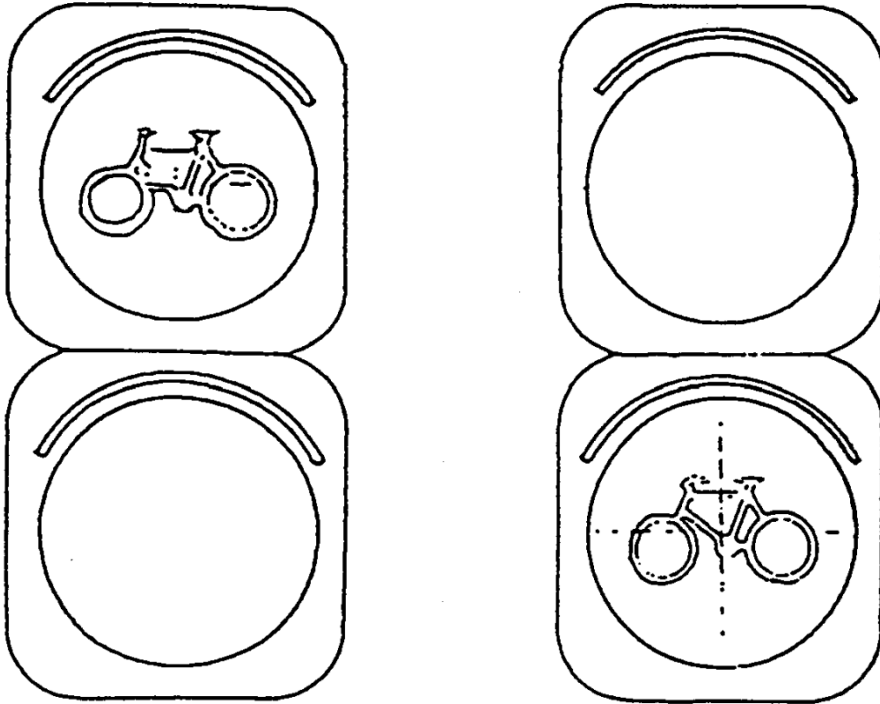

RED BICYCLE

GREEN BICYCLE

LIGHT SIGNALS FOR BICYCLES

THE SCHEDULE — *continued*

DIAGRAM 130

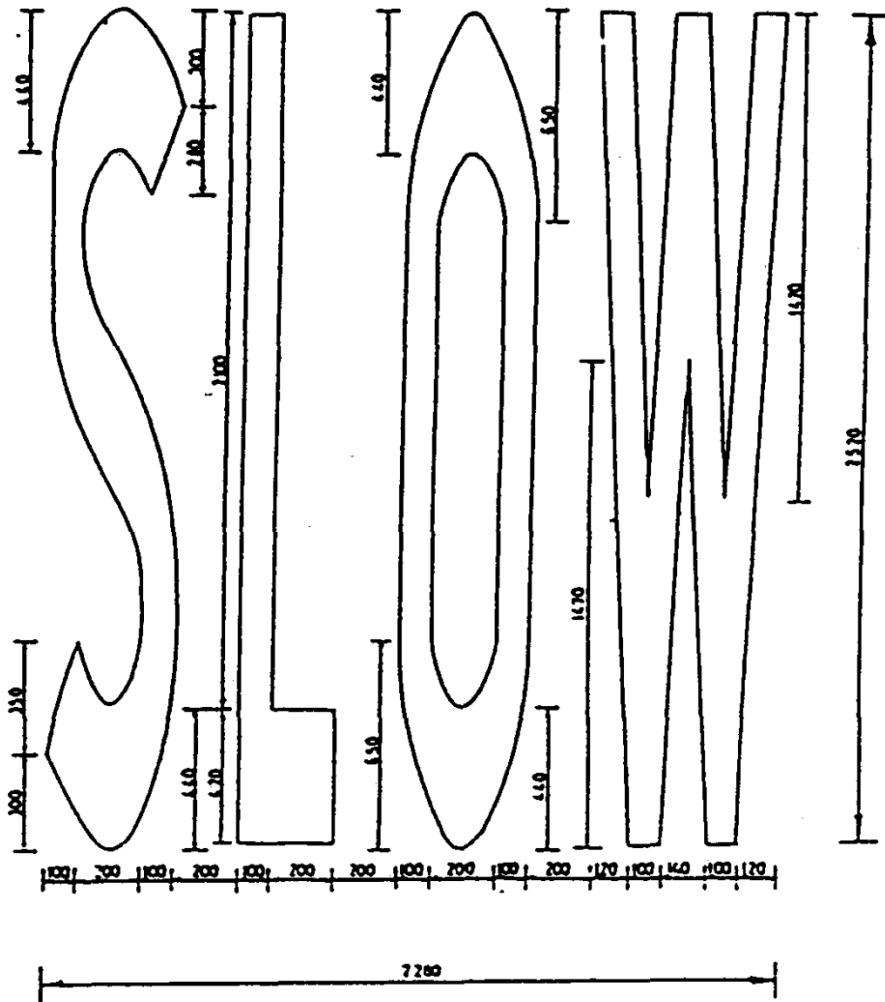

SCALE: 1:20

THE SCHEDULE — continued

DIAGRAM 131

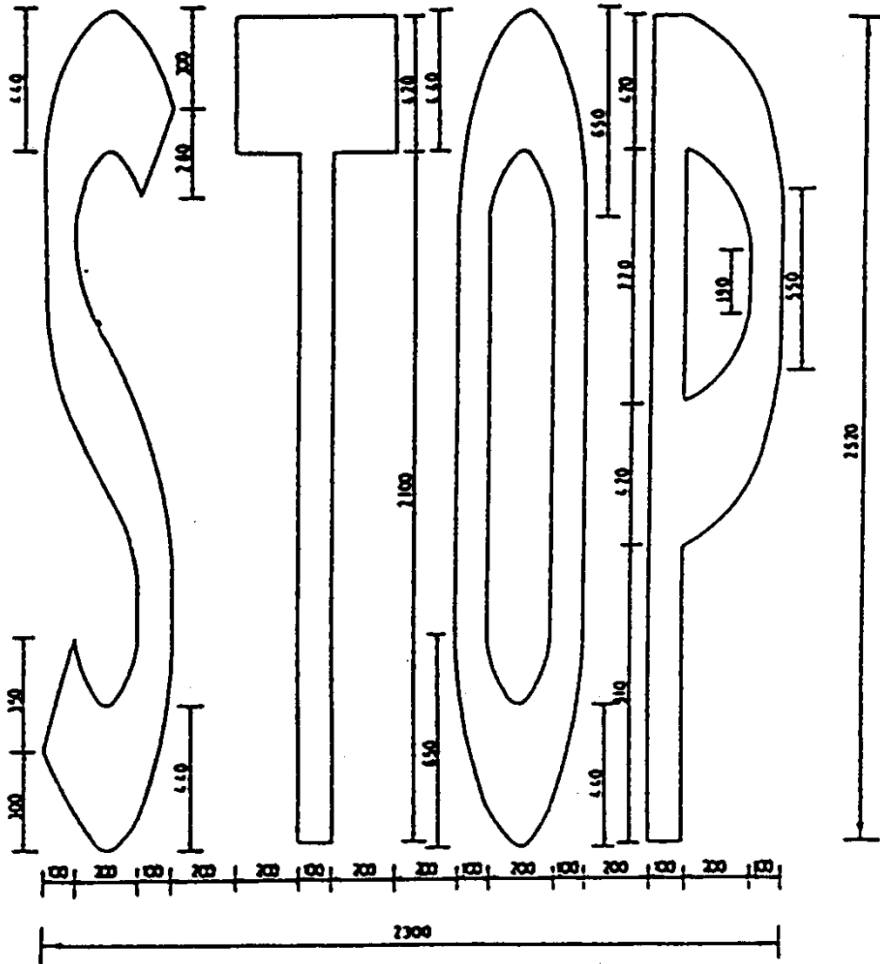

SCALE: 1:20

THE SCHEDULE — *continued*

DIAGRAM 132

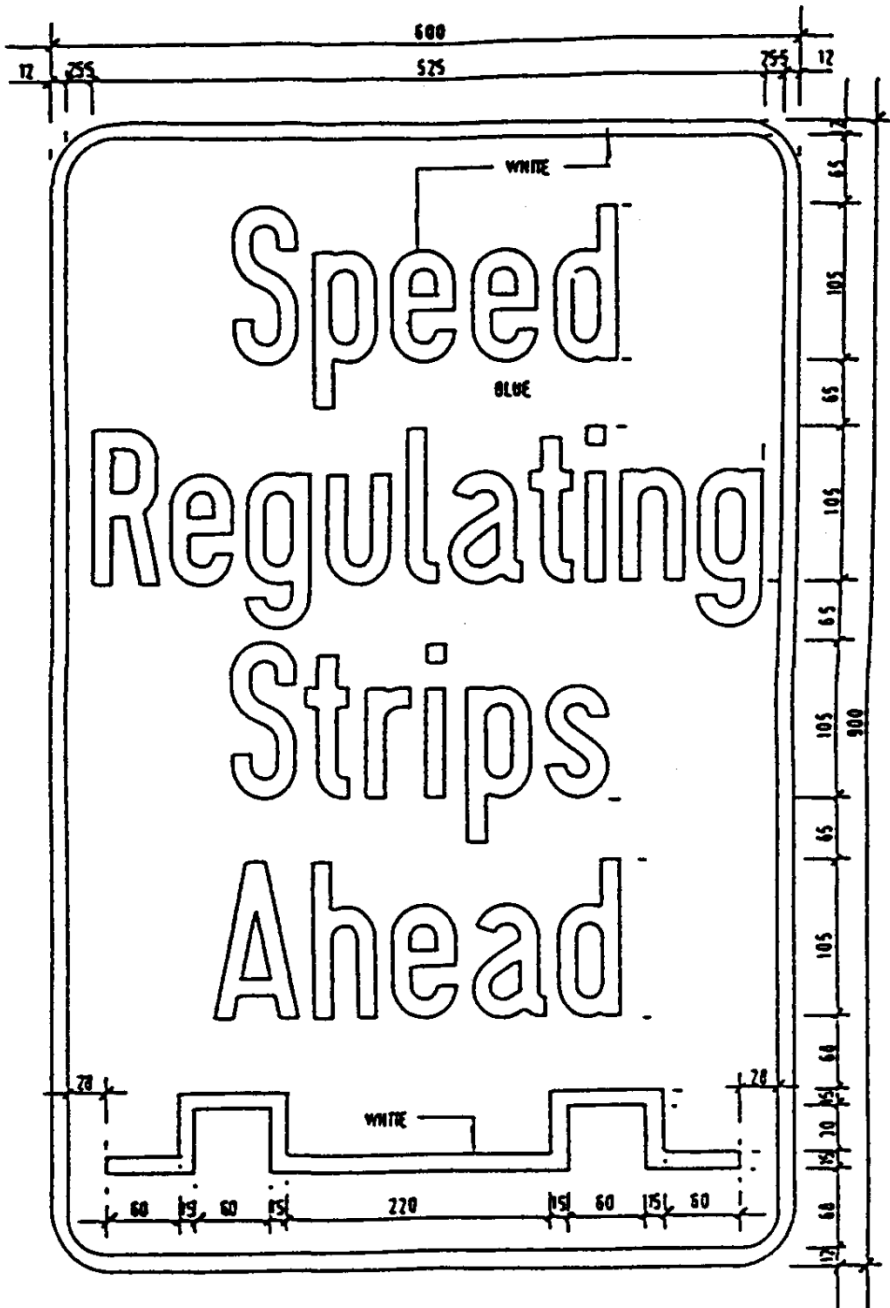

SPEED REGULATING STRIPS AHEAD

THE SCHEDULE — *continued*

DIAGRAM 133

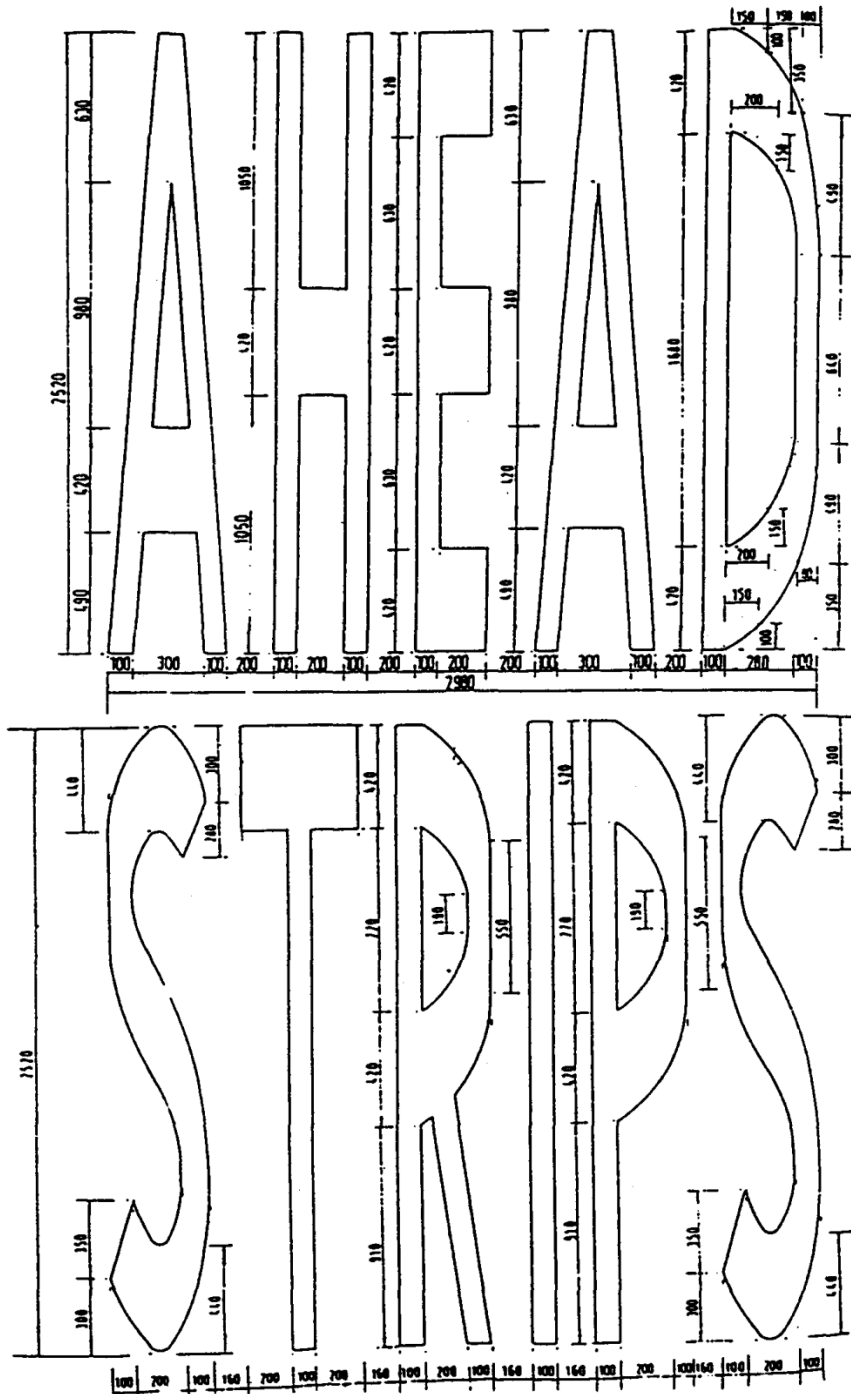

THE SCHEDULE — *continued*

DIAGRAM 134

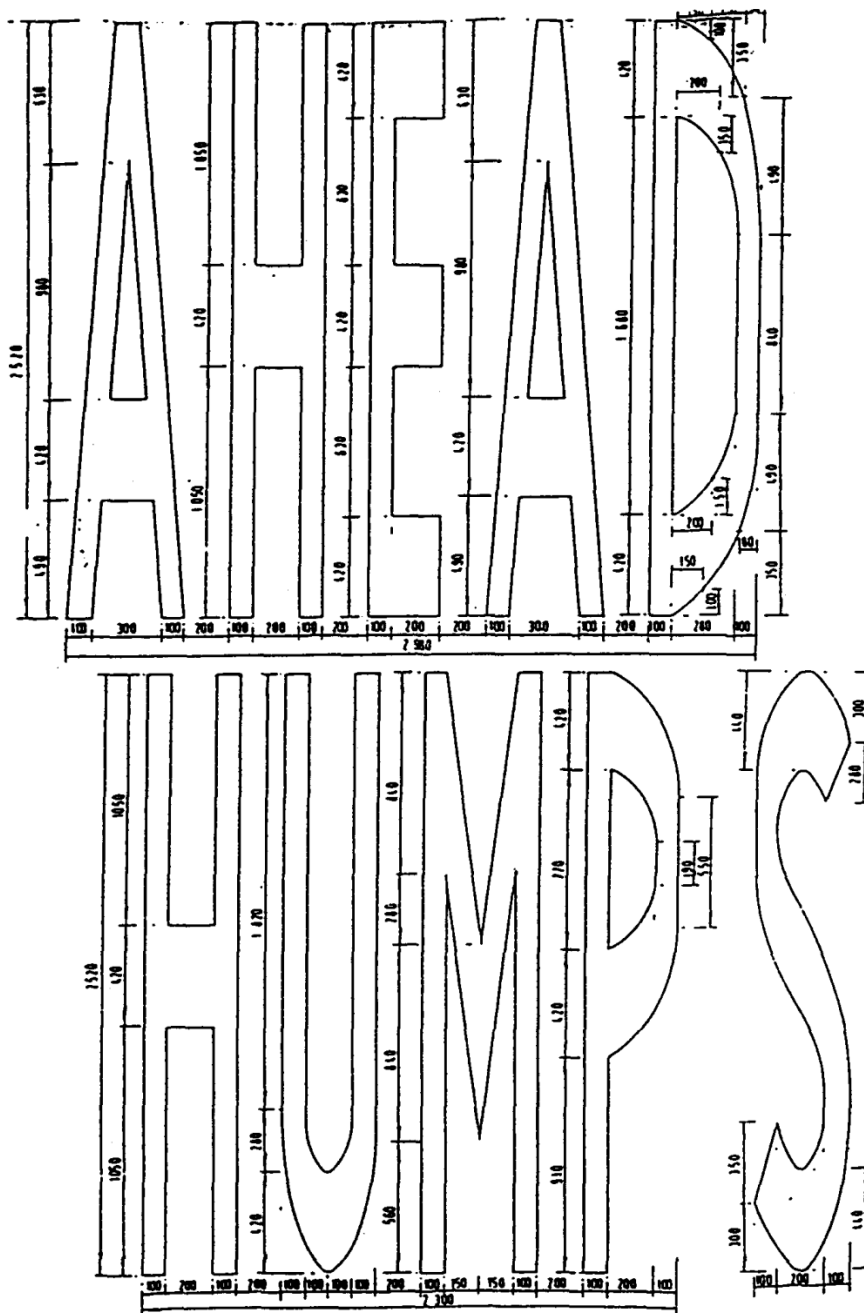

THE SCHEDULE — continued

DIAGRAM 135

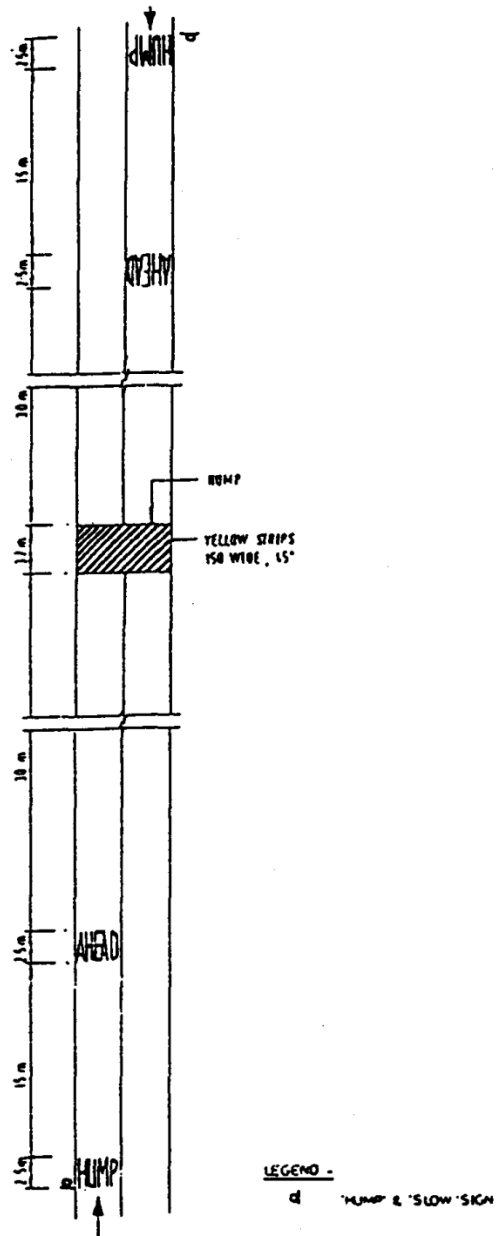

MARKINGS FOR A ROAD HUMP

THE SCHEDULE — *continued*

DIAGRAM 135A

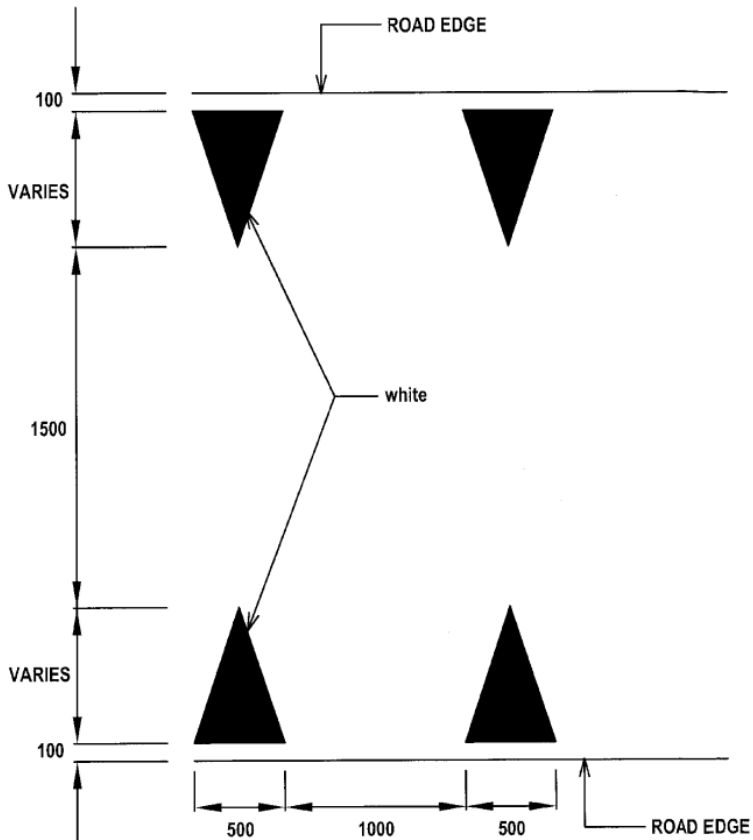

TRAFFIC CALMING MARKINGS

These markings consist of 2 rows of white triangles which are intended to create a visually narrowed lane to slow down the speed of motorists.

[S 257/2009 wef 08/06/2009]

THE SCHEDULE — continued

DIAGRAM 136

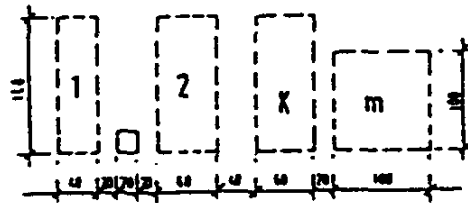
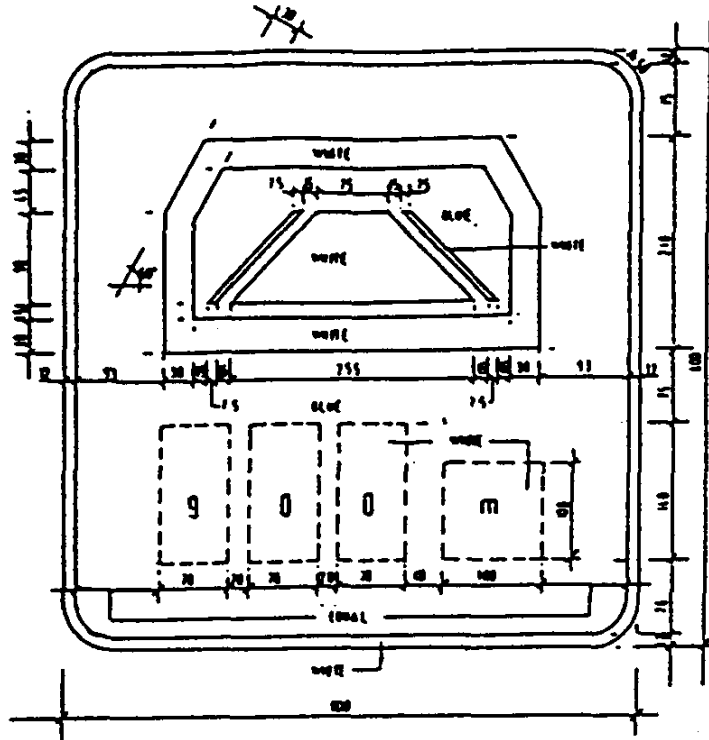

START OF TUNNEL

THE SCHEDULE — *continued*

DIAGRAM 137

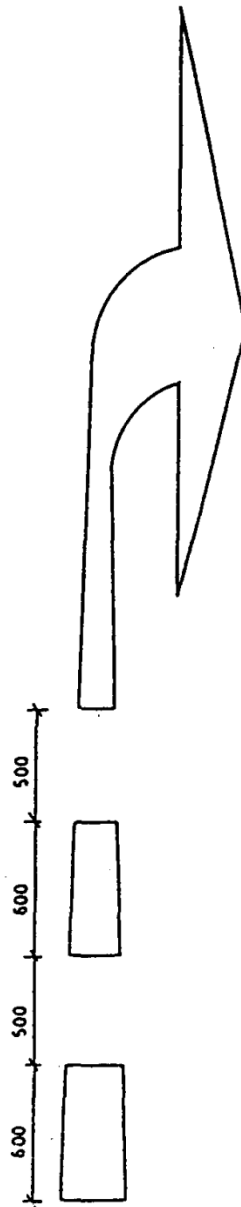

LANE INDICATION ARROWS (WITH TIME RESTRICTIONS)

THE SCHEDULE — *continued*

DIAGRAM 138 (a)

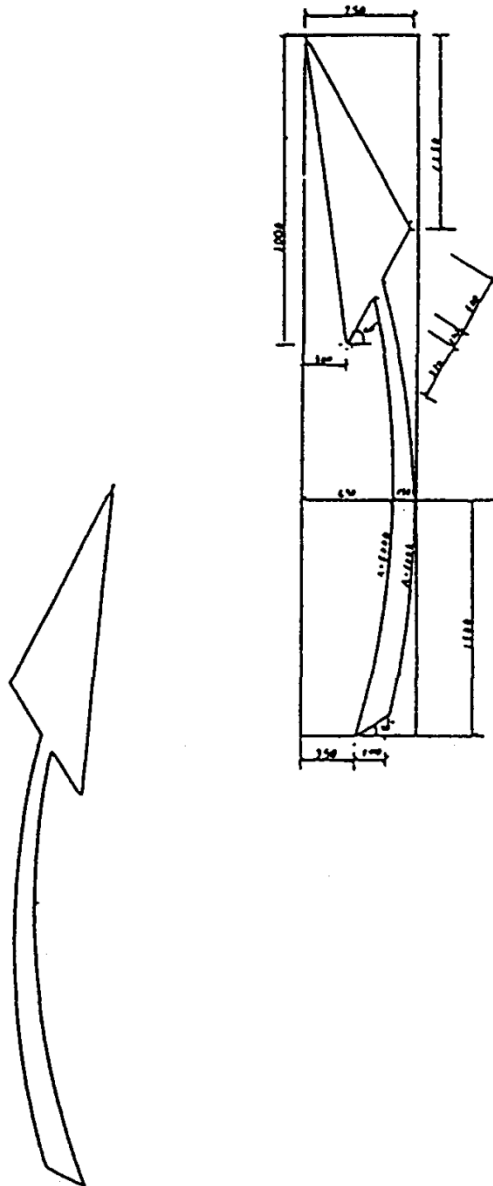

MERGE ARROWS

This marking indicates that the 2 lanes with the marking will merge into a single lane ahead.

THE SCHEDULE — *continued*

DIAGRAM 138 (b)

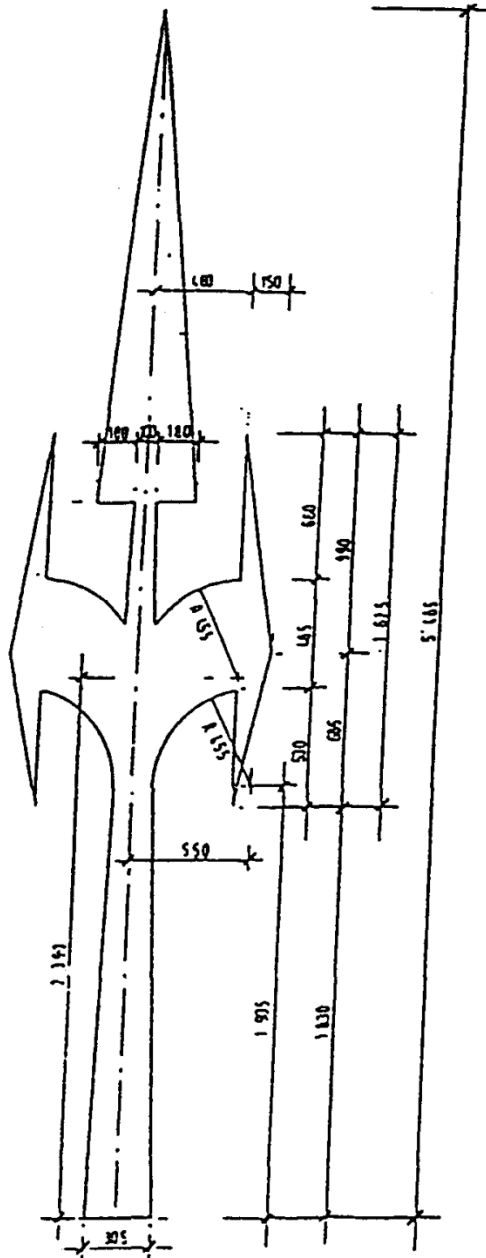

SHARED ARROW

THE SCHEDULE — continued

This marking indicates that vehicles on the lane with the marking may only proceed ahead, turn left or right.

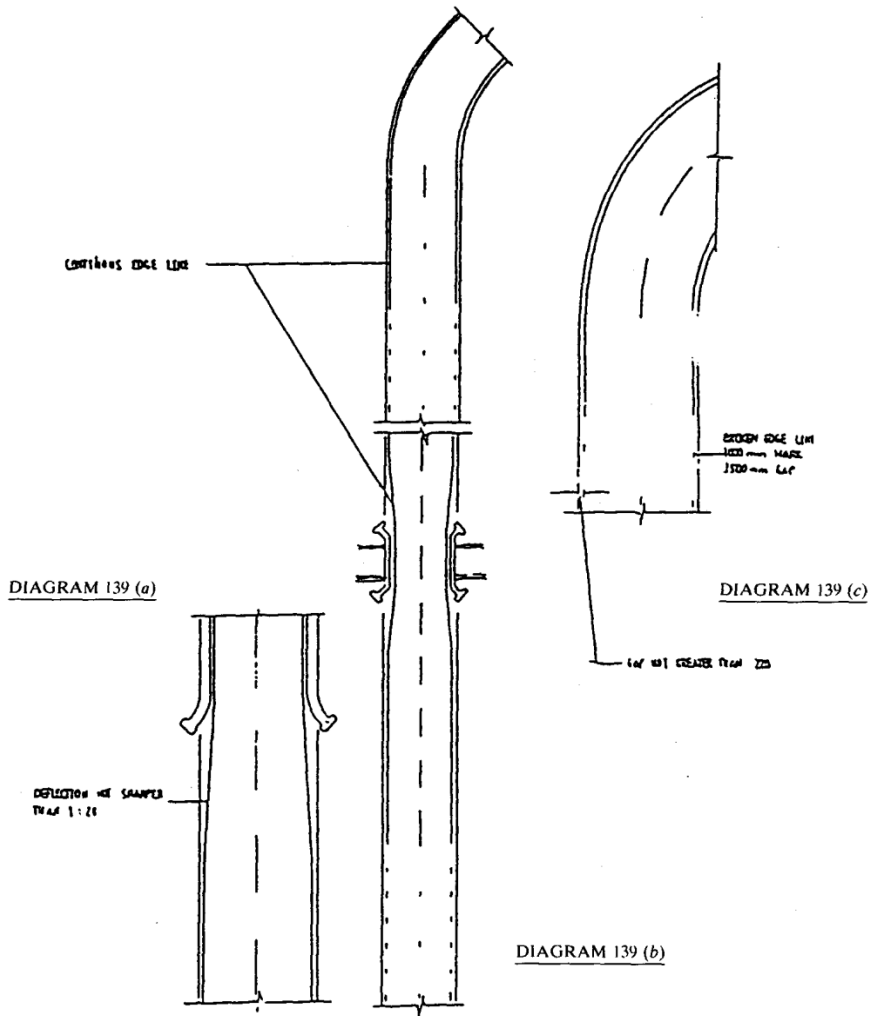

EDGE OF ROAD MARKINGS

THE SCHEDULE — *continued*

DIAGRAM 140 (a)

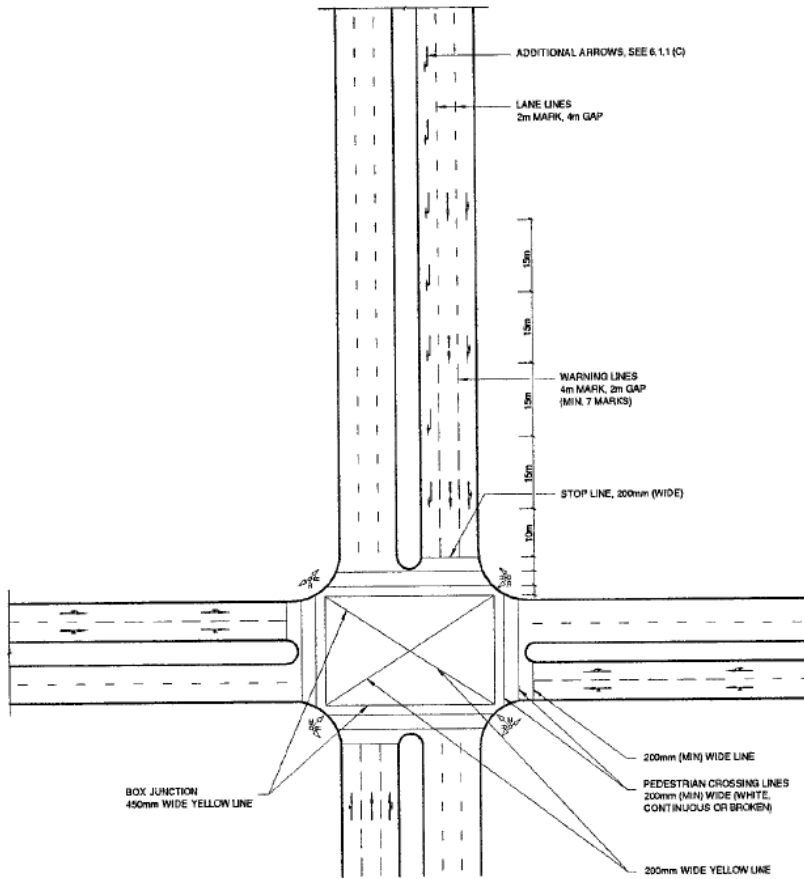

MARKINGS AT SIGNAL-CONTROLLED JUNCTION

[S 572/2005 wef 01/09/2005]

THE SCHEDULE — *continued*

DIAGRAM 140 (b)

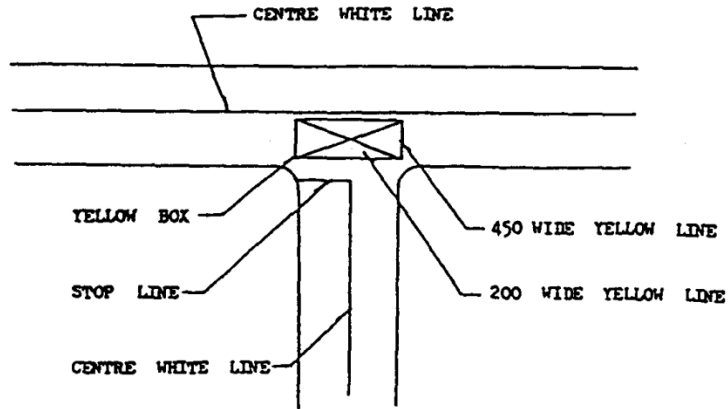

YELLOW BOX AT JUNCTION

DIAGRAM 140 (c)

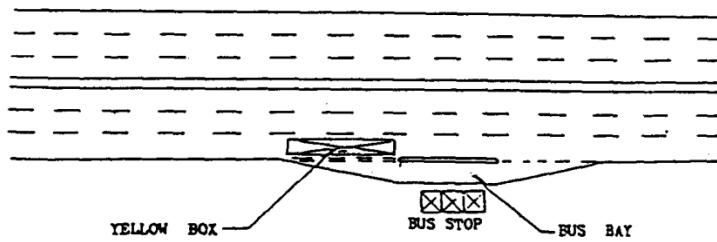

YELLOW BOX NEAR BUS BAY

THE SCHEDULE — *continued*

DIAGRAM 140 (d)

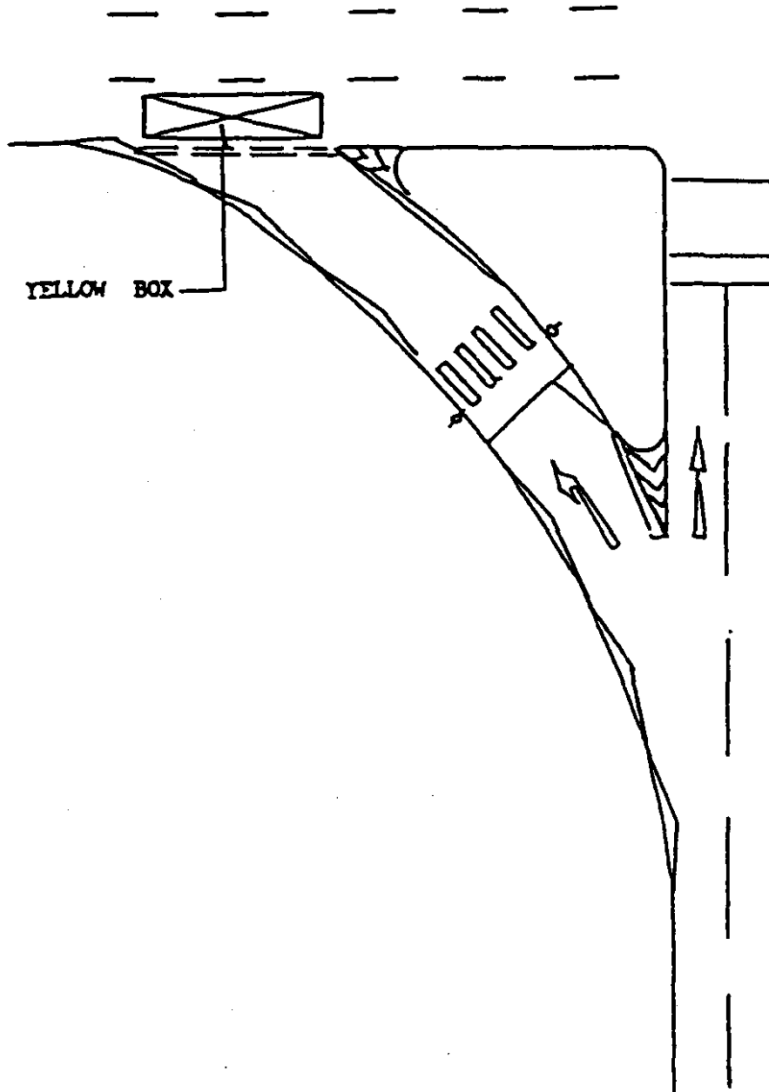

YELLOW BOX AT EXIT OF SLIP ROAD

THE SCHEDULE — *continued*

DIAGRAM 140 (e)

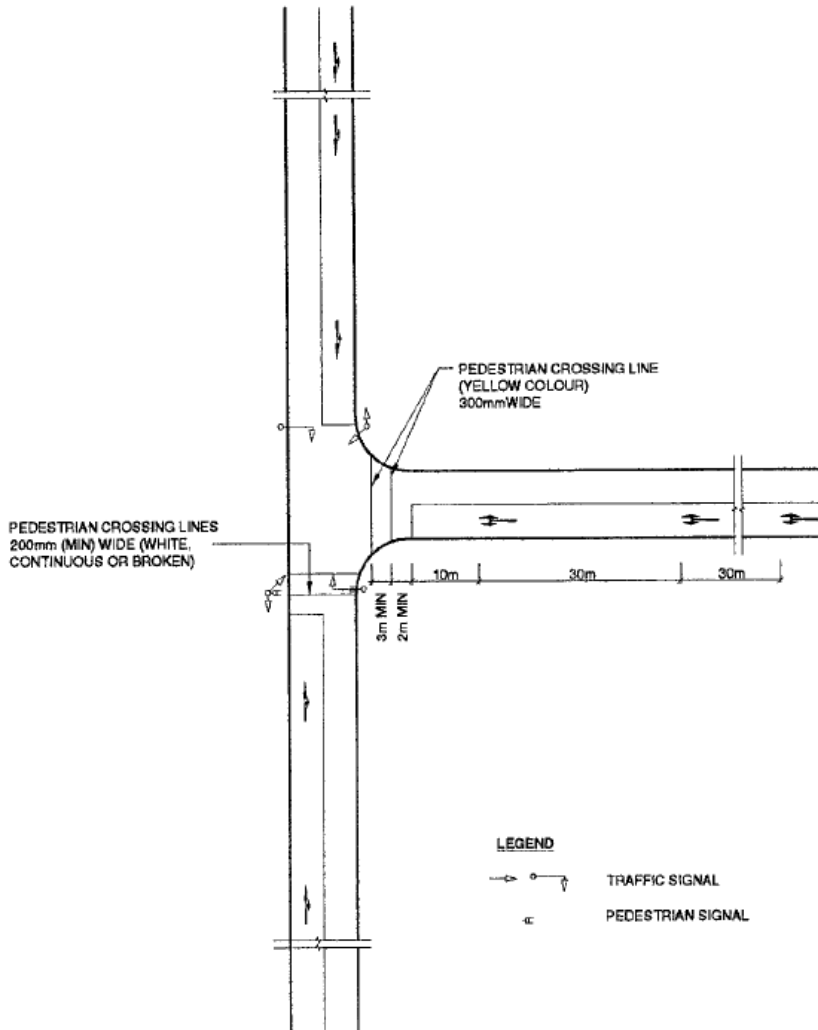

MARKINGS AT SIGNAL-CONTROLLED JUNCTION

[S 572/2005 wef 01/09/2005]

THE SCHEDULE — *continued*

DIAGRAM 140 (f)

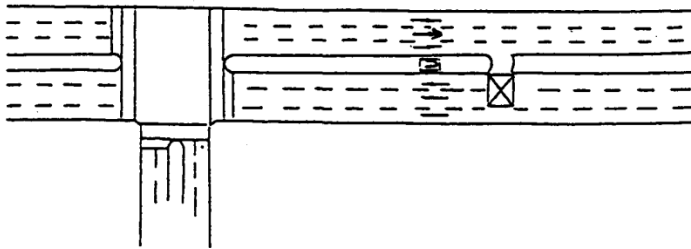

YELLOW BOX NEAR 'U' TURN OPENING

DIAGRAM 140 (g)

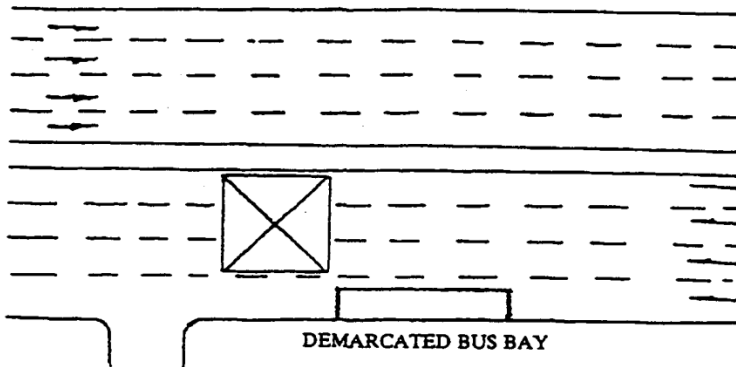

YELLOW BOX NEAR DEMARCATED BUS BAY

DIAGRAM 140 (h)

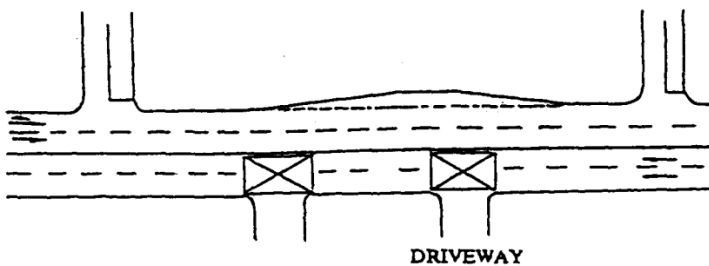

YELLOW BOX NEAR DRIVEWAY

THE SCHEDULE — *continued*

DIAGRAM 140 (i)

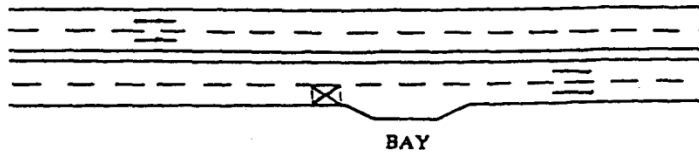

YELLOW BOX NEAR BAY

DIAGRAM 141

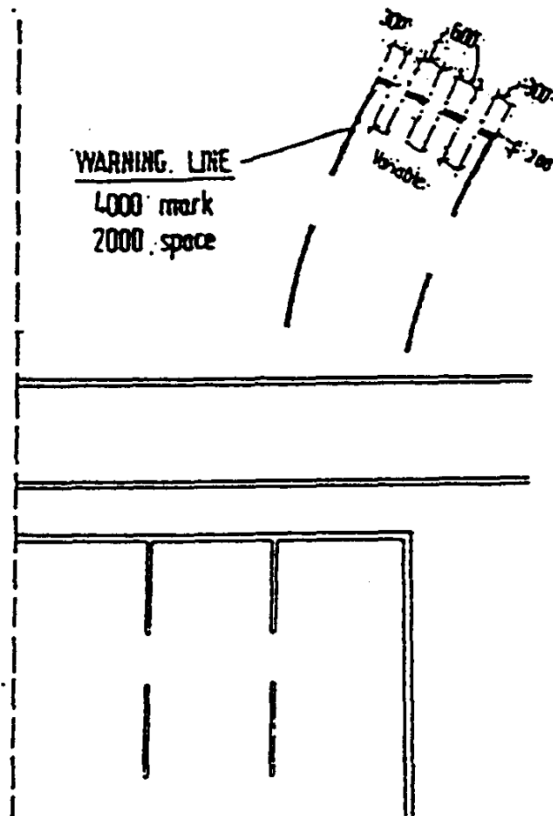

RIGHT TURN POCKET

This marking is intended to guide motorists making a right turning at a junction as to the path they should take.

THE SCHEDULE — *continued*

DIAGRAM 142 (a)

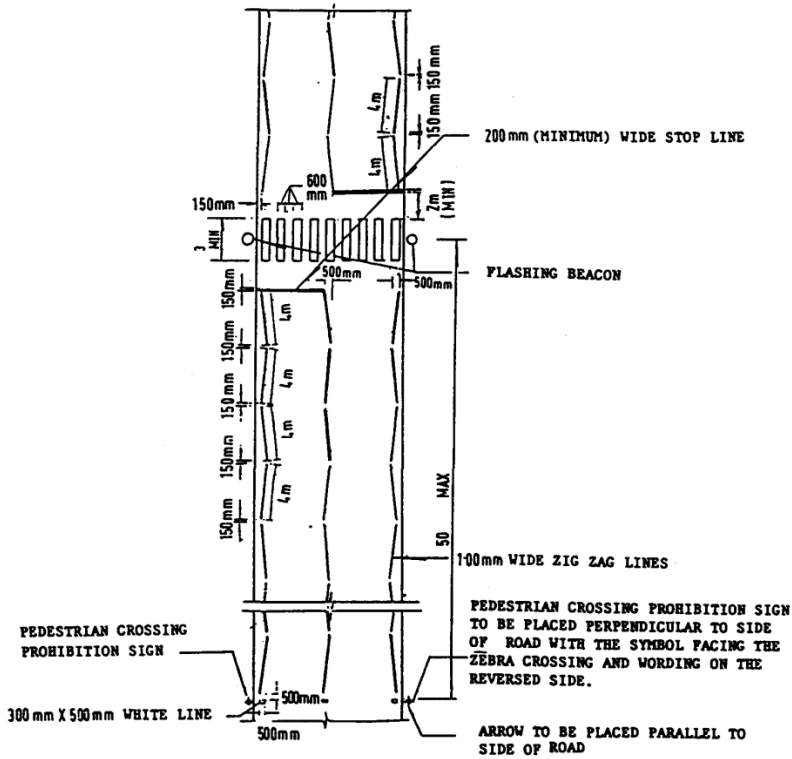

THE SCHEDULE — *continued*

DIAGRAM 142 (b)

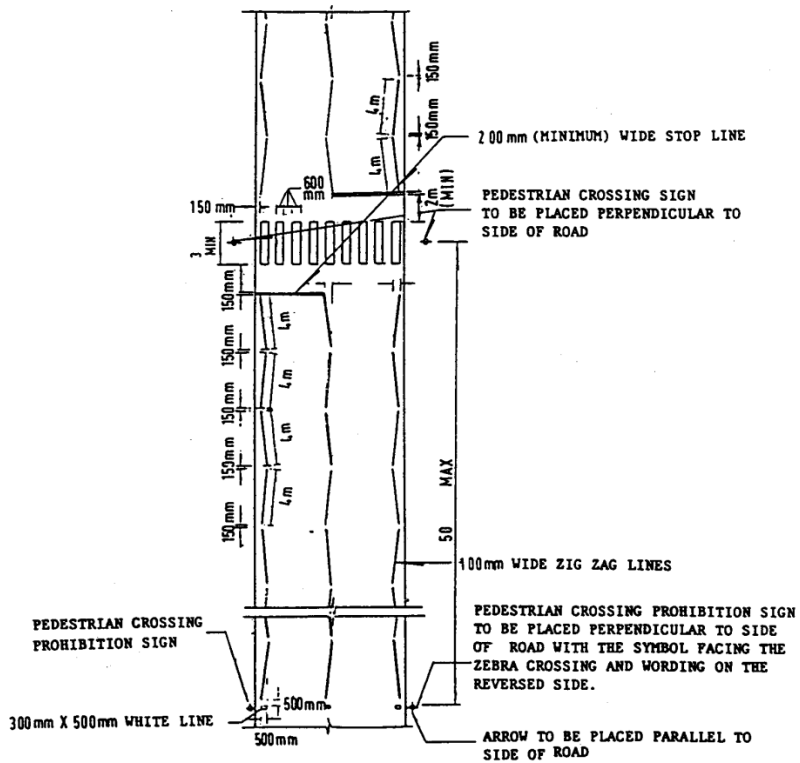

THE SCHEDULE — *continued*

DIAGRAM 143 (a)

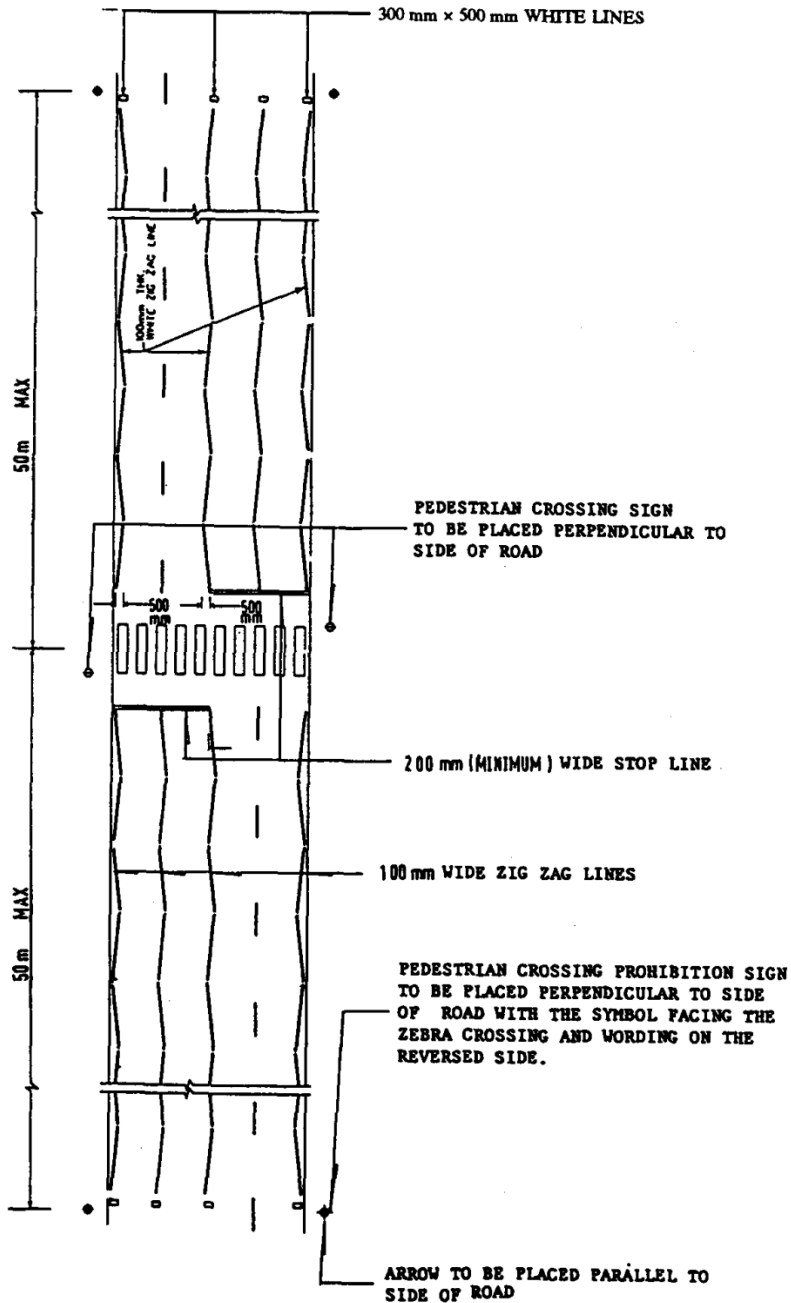

THE SCHEDULE — continued

DIAGRAM 143 (b)

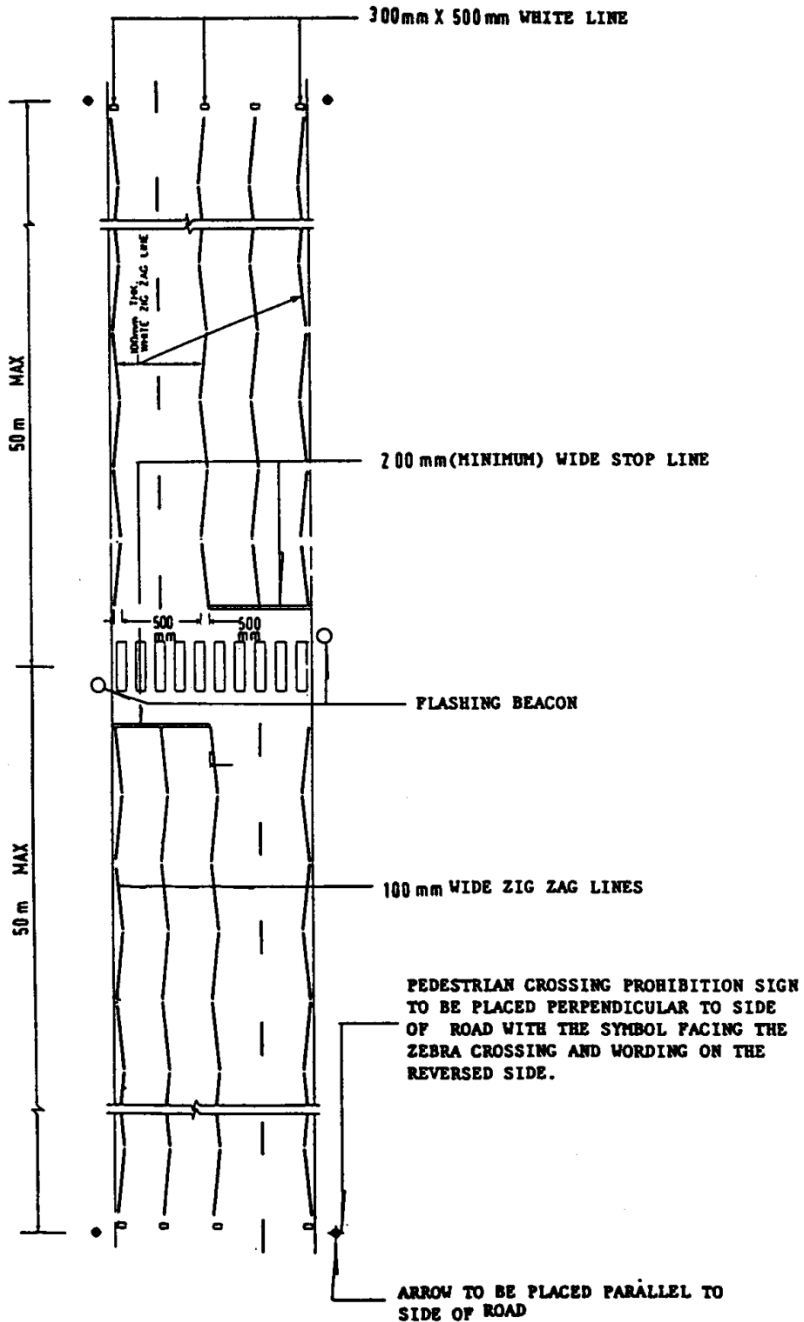

THE SCHEDULE — *continued*

DIAGRAM 144 (a)

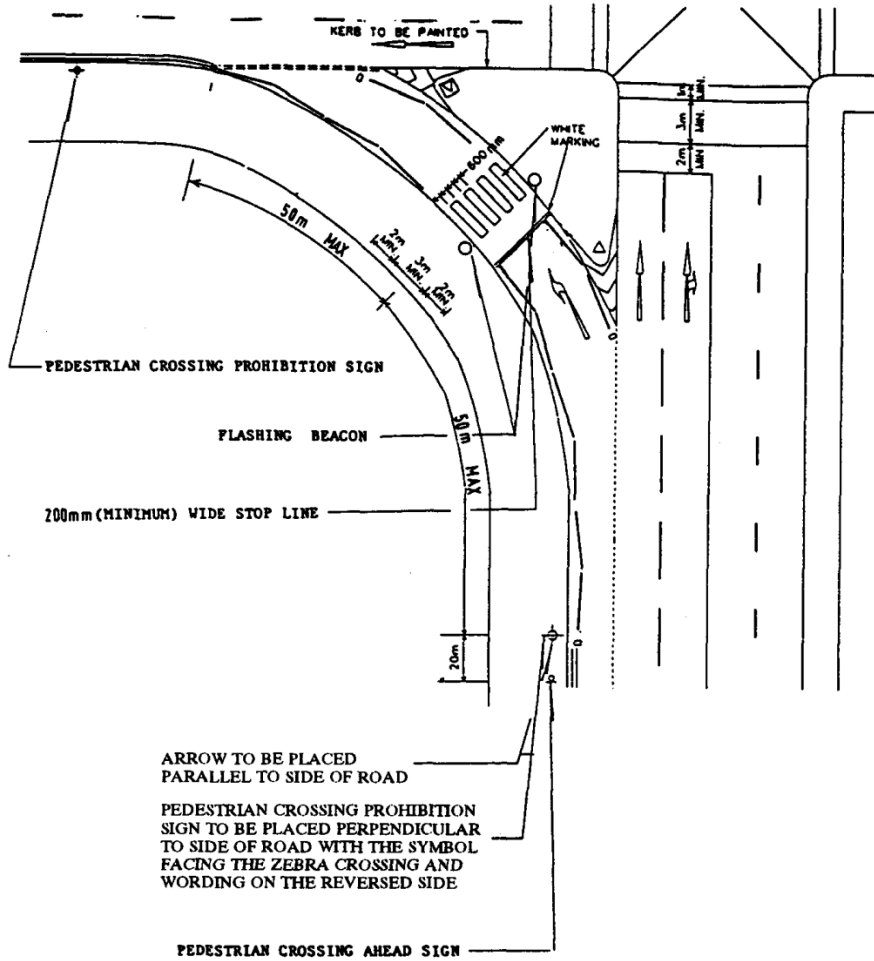

THE SCHEDULE — *continued*

DIAGRAM 144 (b)

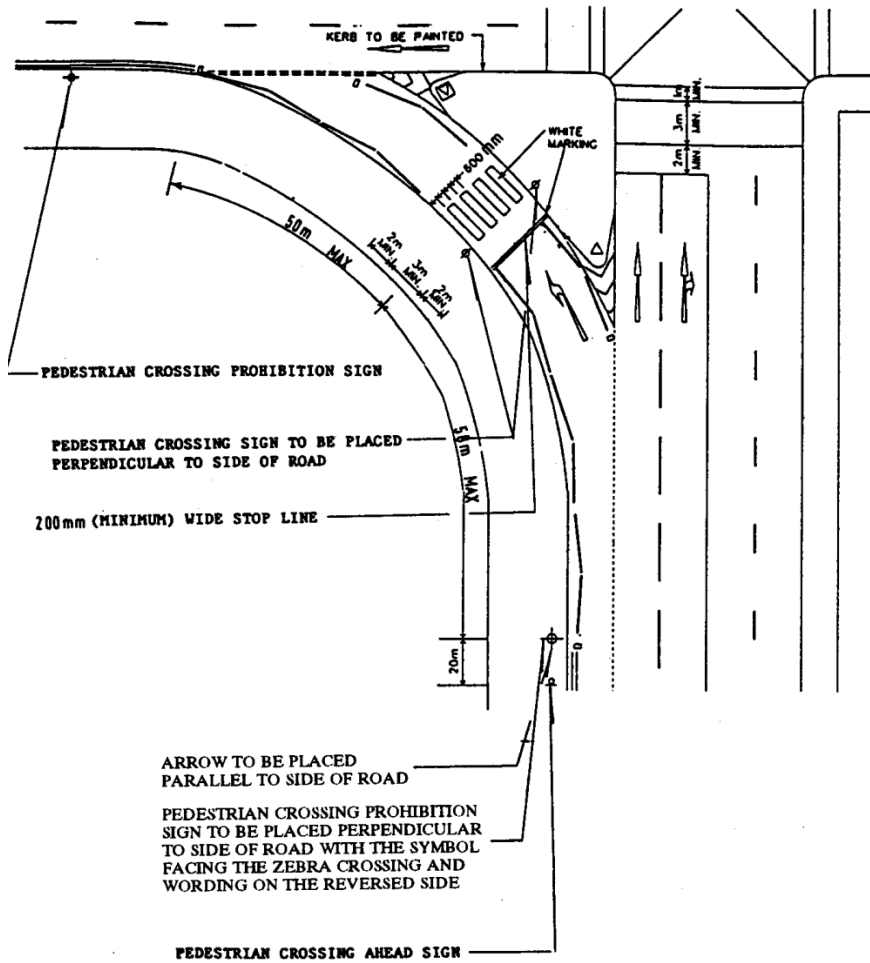

THE SCHEDULE — *continued*

DIAGRAM 145

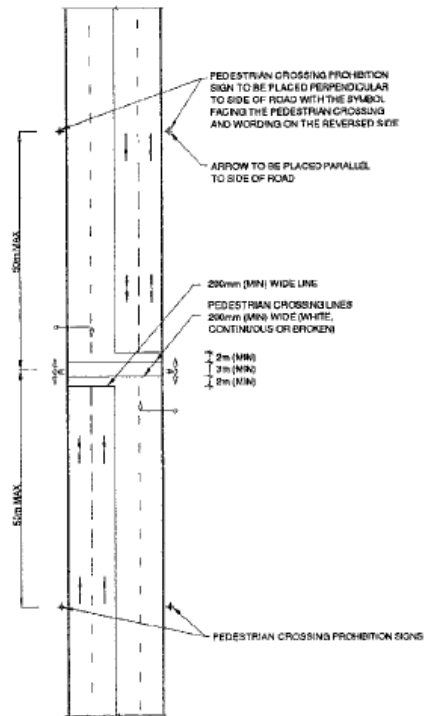

SIGNALISED PEDESTRIAN CROSSING

[S 572/2005 wef 01/09/2005]

THE SCHEDULE — continued

DIAGRAM 145 (a)

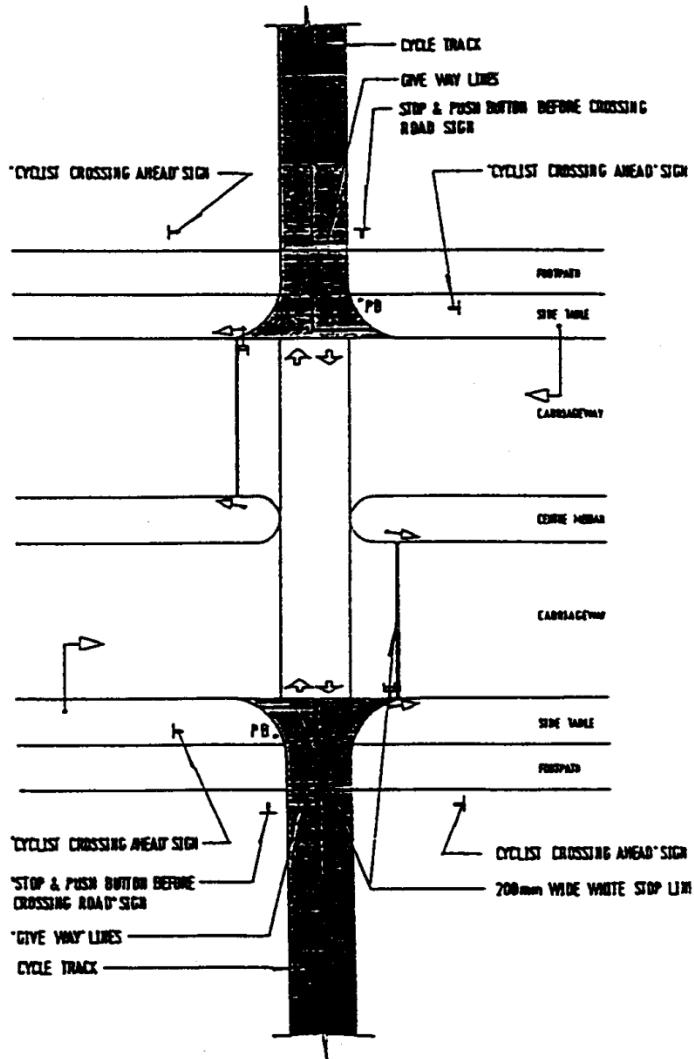

SIGNALISED BICYCLE CROSSING

THE SCHEDULE — *continued*

DIAGRAM 146

U-TURN MARKINGS

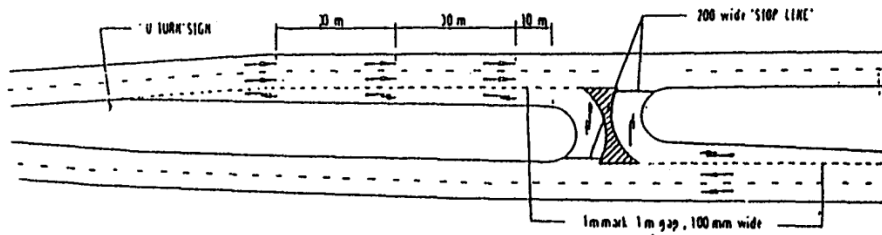

TYPICAL U-TURN MARKINGS ON A DUAL-CARRIAGEWAY

SCALE: 1:1000

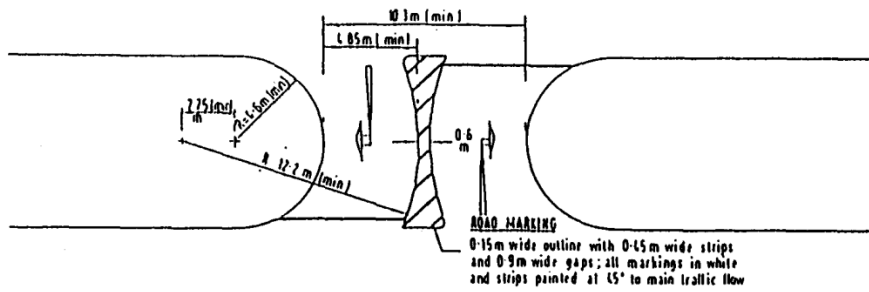

U-TURN MARKINGS

THE SCHEDULE — *continued*

DIAGRAM 147

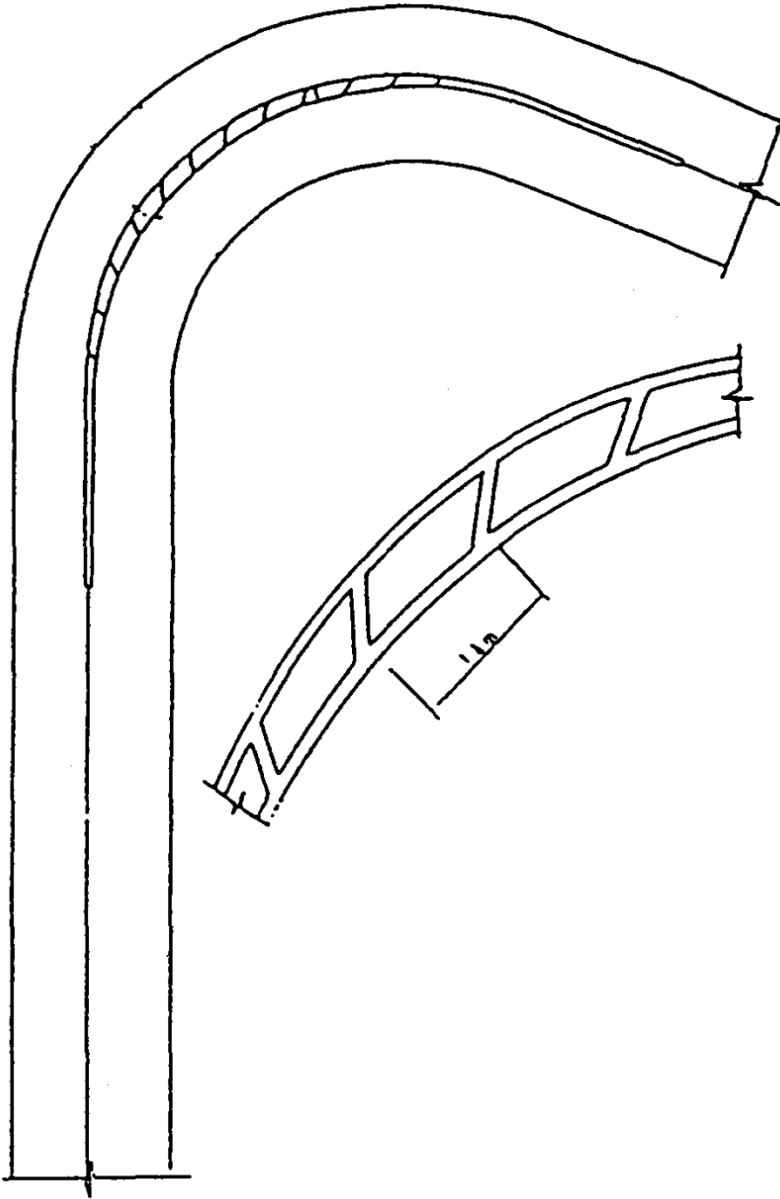

DOUBLE LINES AND HATCHED MARKINGS ON SHARP BENDS

THE SCHEDULE — *continued*

DIAGRAM 148 (a)

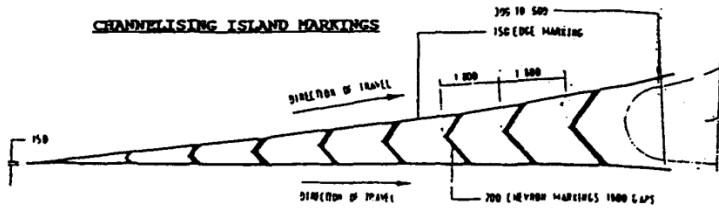

DIVERGING TRAFFIC

DIAGRAM 148 (b)

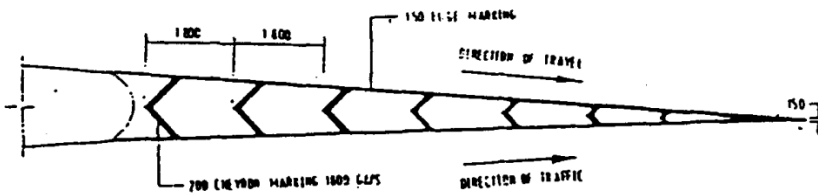

MERGING TRAFFIC

DIAGRAM 148 (c)

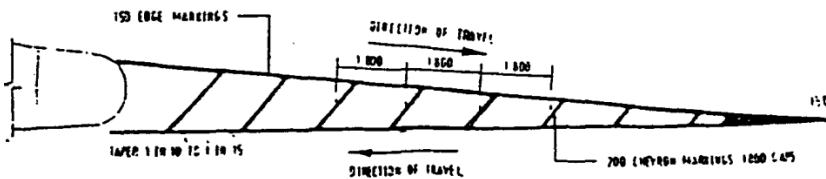

TWO WAY TRAFFIC CHEVRON MARKINGS

THE SCHEDULE — *continued*

DIAGRAM 149 (a)

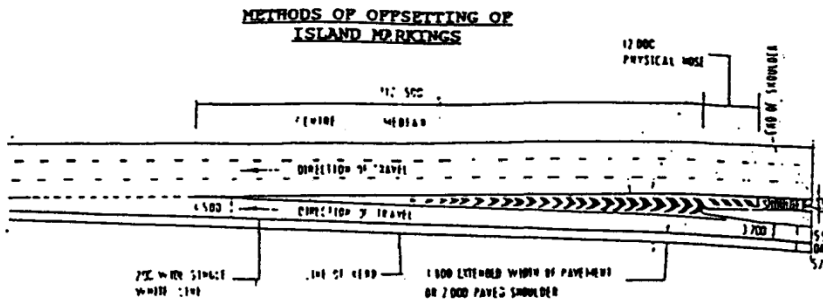

ACCELERATION LANE

SINGLE ENTRY

DIAGRAM 149 (b)

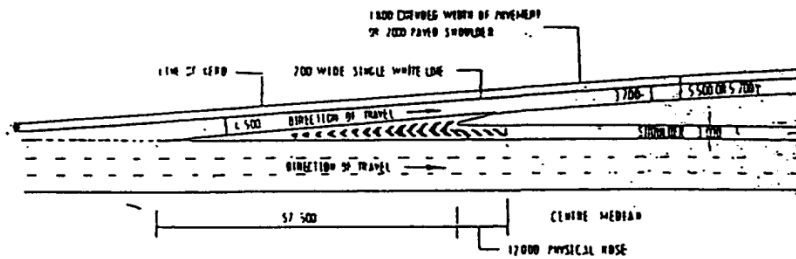

DECELERATION LANE

SINGLE ENTRY

DIAGRAM 149 (c)

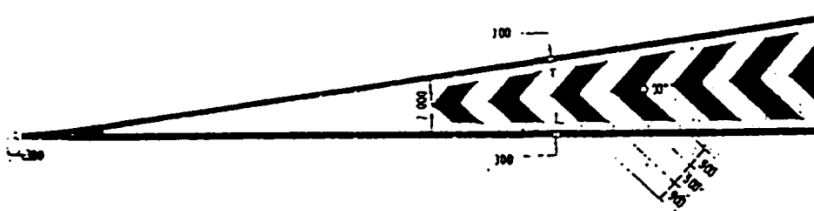

CHEVRON MARKINGS FOR EXPRESSWAY

THE SCHEDULE — continued

DIAGRAM 149 (d)

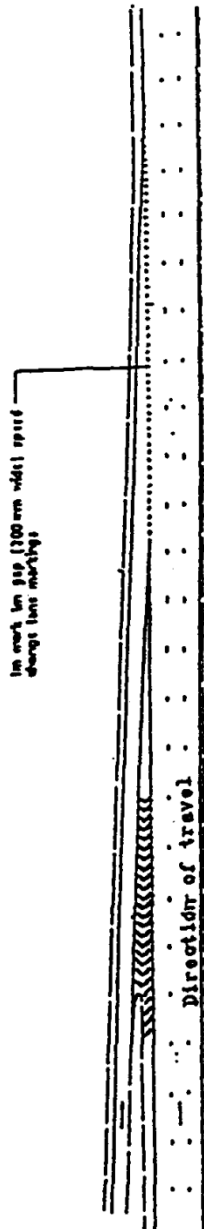
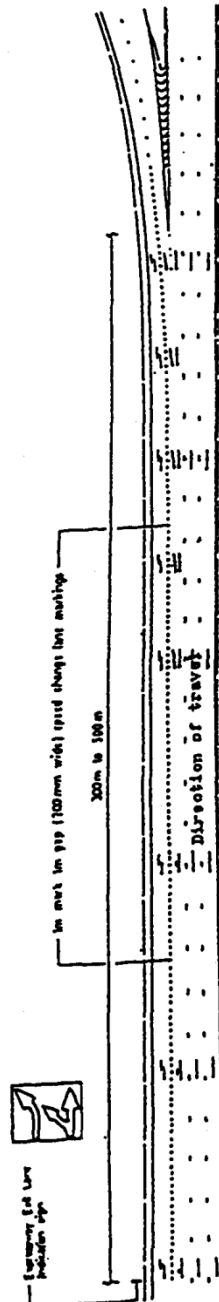
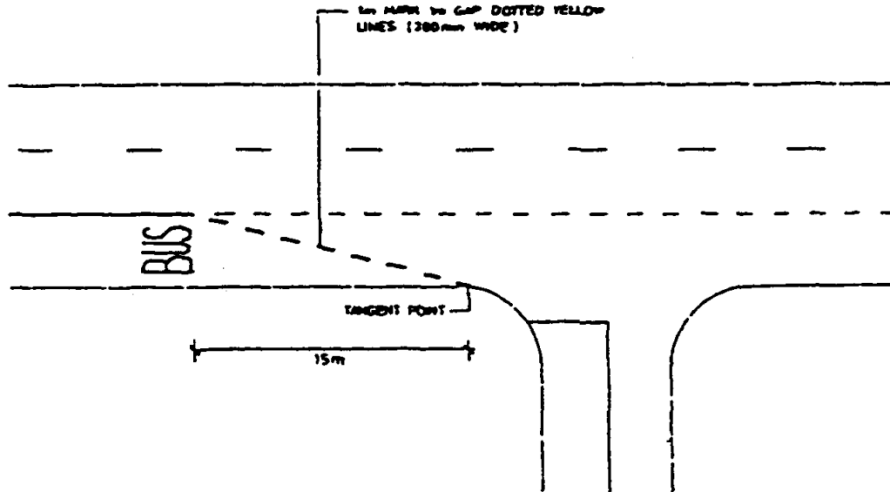

DIAGRAM 149 (e)



THE SCHEDULE — *continued*

DIAGRAM 149 (f)



INCLINED BROKEN YELLOW LINE

The line is used to guide drivers emerging from the side road to keep away from the leftmost traffic lane which is a bus lane. It gives the road user advance warning and provides clearer guidance to motorists of bus lane ahead.

DIAGRAM 150 (a)

LONGITUDINAL MARKINGS

CENTRE / LANE LINES

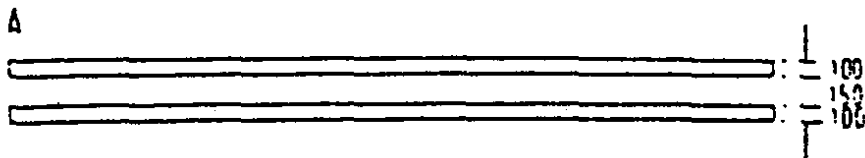

DOUBLE WHITE LINES AT THE CENTRE OF A TWO WAY ROAD
OR BETWEEN LANES

THE SCHEDULE — *continued*

DIAGRAM 150 (b)

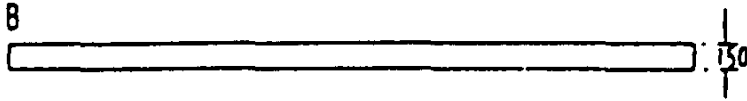

SINGLE WHITE LINE AT THE CENTRE OF A TWO WAY ROAD

DIAGRAM 150 (c)

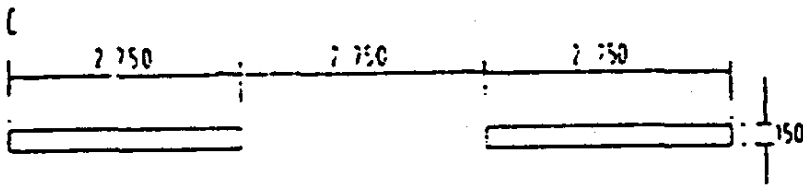

BROKEN WHITE LINES AT THE CENTRE OF A TWO WAY ROAD

DIAGRAM 150 (d)

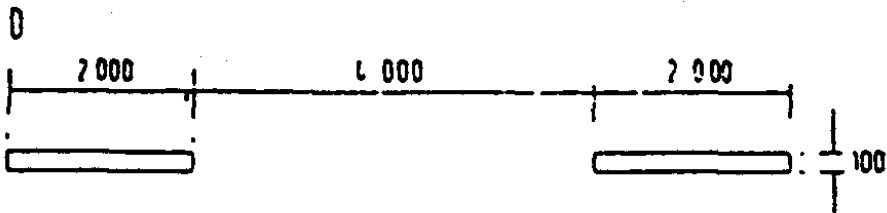

BROKEN WHITE LINES BETWEEN LANES

THE SCHEDULE — *continued*

DIAGRAM 151 (a)

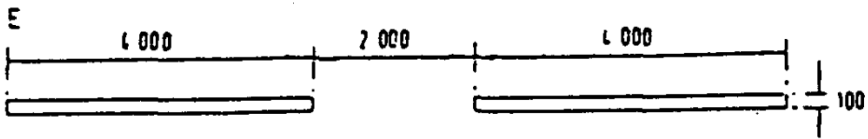

BROKEN WHITE LINES BETWEEN LANES
INDICATING THE APPROACH TO A STOP LINE AT A JUNCTION

DIAGRAM 151 (b)

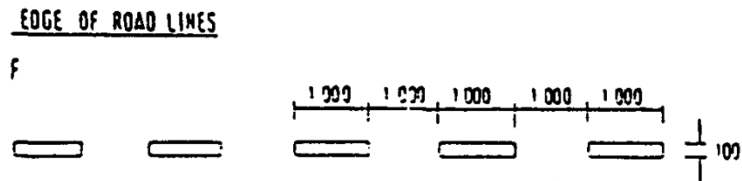

BROKEN WHITE LINES INDICATING THE EDGE OF
THE MAIN ROAD AT —

- (i) Bus Bay and Lay-Bys
- (ii) Slip road, including acceleration and deceleration lanes
- (iii) Exclusive right turn lanes

DIAGRAM 151 (c)

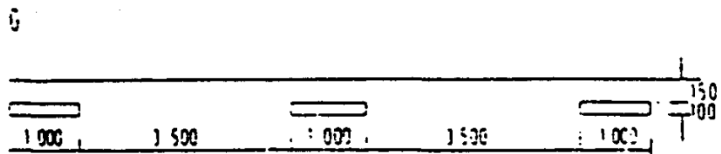

BROKEN WHITE LINES INDICATING THE EDGE OF
UNDIVIDED STRAIGHT ROAD

THE SCHEDULE — *continued*

DIAGRAM 151 (d)

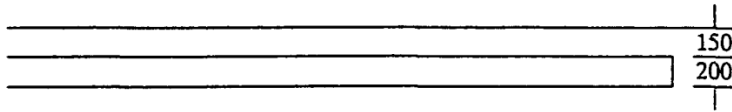

SINGLE WHITE LINE INDICATING THE EDGE OF A ROAD WHERE THERE IS IMMINENT HAZARD

DIAGRAM 151 (e)

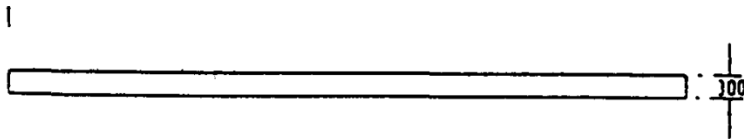

SINGLE WHITE LINE DEMARCATING THE HARD SHOULDER SECTION ON AN EXPRESSWAY

DIAGRAM 151 (f)

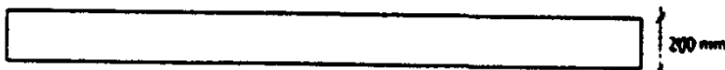

An edgeline is a continuous white line of a width of 200 mm painted alongside the edge of a carriageway or alongside the central dividing kerb of a dual carriageway. It is a supplementary guiding line to be provided on selected roads wherever necessary.

DIAGRAM 152 (a)

PARKING RESTRICTION LINES

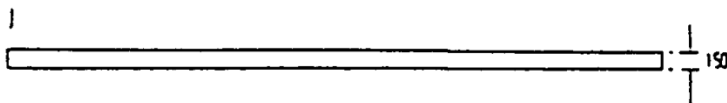

Single yellow line at the edge of a road prohibiting parking from 7am to 7pm on any day except Sundays or gazetted public holidays.

THE SCHEDULE — *continued*

DIAGRAM 152 (b)

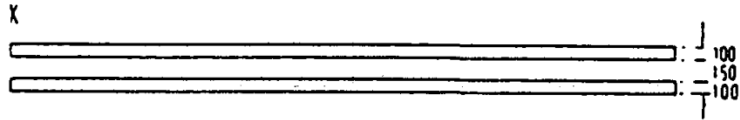

Double yellow lines at the edge of a road prohibiting parking at all times.

DIAGRAM 152 (c)

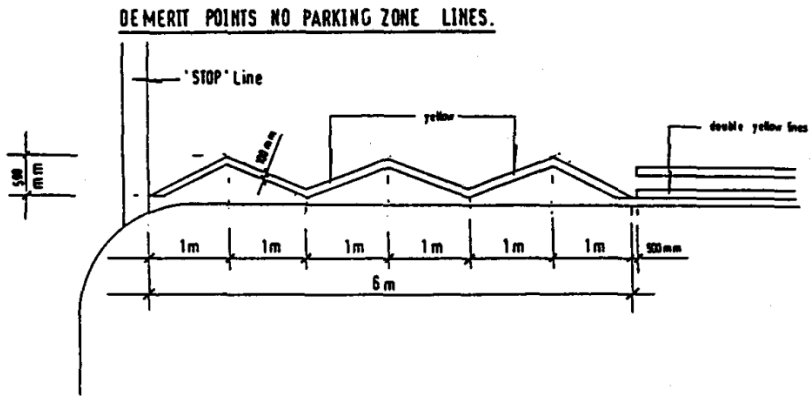

Single zig zag yellow line at the edge of a road prohibiting parking at all times.

THE SCHEDULE — *continued*

DIAGRAM 152 (d)

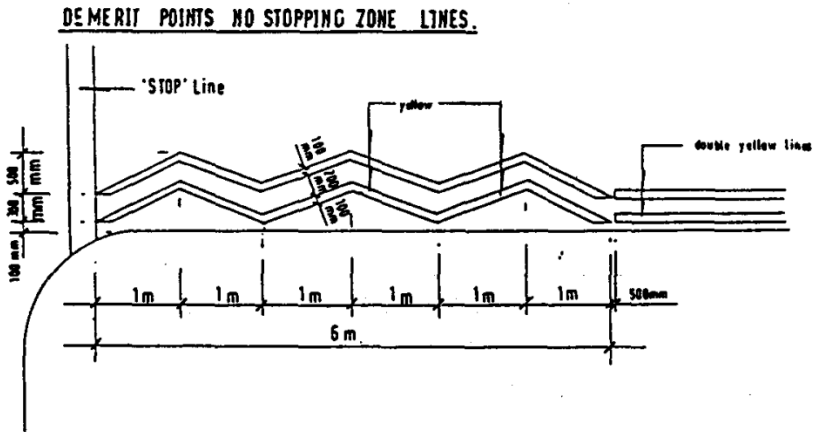

Double zig zag yellow lines at the edge of a road prohibiting stopping of vehicles at all times unless the vehicle is prevented from proceeding due to traffic conditions.

DIAGRAM 152(e)

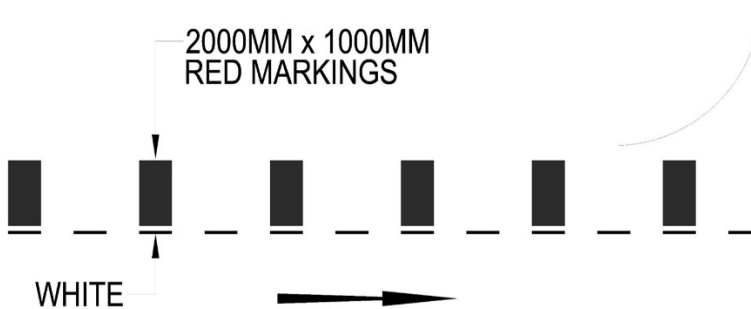

The red transverse lines of not less than 1,000 mm in width are laid down perpendicular to the edge of a road. These lines indicate that the parking of any vehicle is prohibited along the length of the road starting from the point where those lines are indicated, to the point the lines end.

[S 172/2017 wef 22/04/2017]

TRANSVERSE MARKINGS

THE SCHEDULE — *continued*

A STOP LINE

DIAGRAM 153

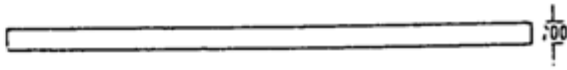

Single white line indicating position on a road where vehicles are required to stop in compliance with a 'STOP' sign, traffic signal or the direction of police officers.

B GIVE WAY LINE

DIAGRAM 154

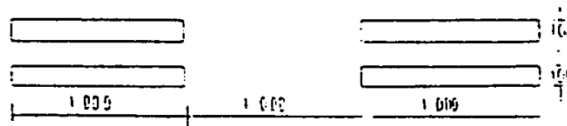

Broken double white lines indicating the position on a road where vehicles are required to give way to traffic on the right or left, as the case may be, in compliance with a 'GIVE WAY' sign.

C GIVE WAY TRIANGULAR MARKING

DIAGRAM 155

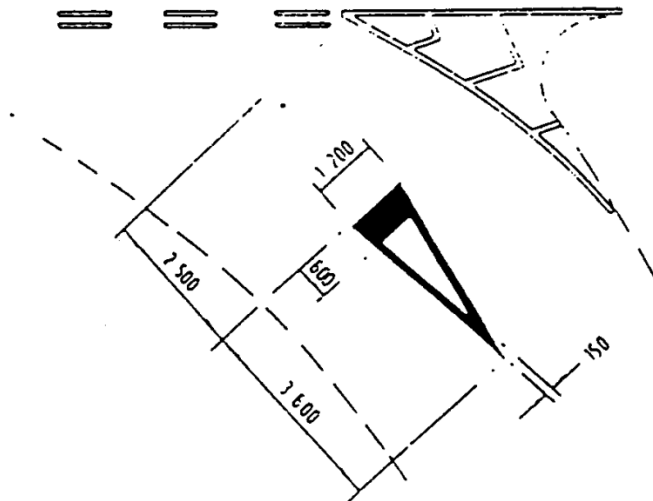

Marking indicating that vehicles are required to give way to traffic on the right or left, as the case may be.

THE SCHEDULE — *continued*

DIAGRAM 156

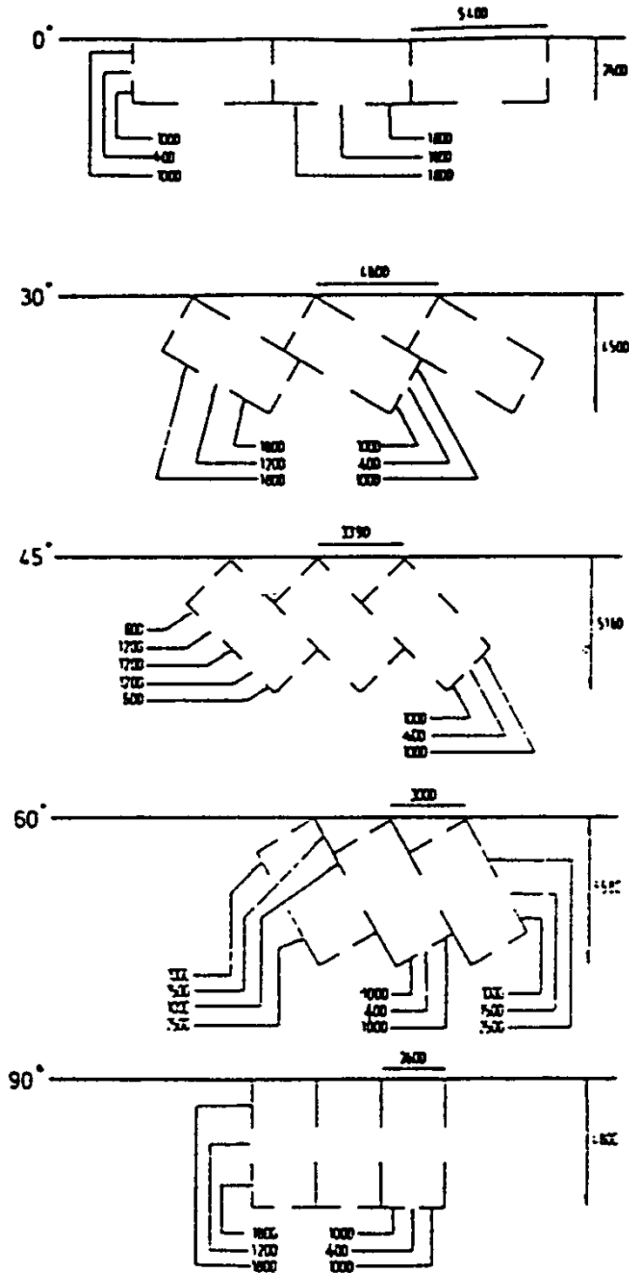

TYPICAL ARRANGEMENT OF PARKING LOTS

THE SCHEDULE — *continued*

DIAGRAM 157

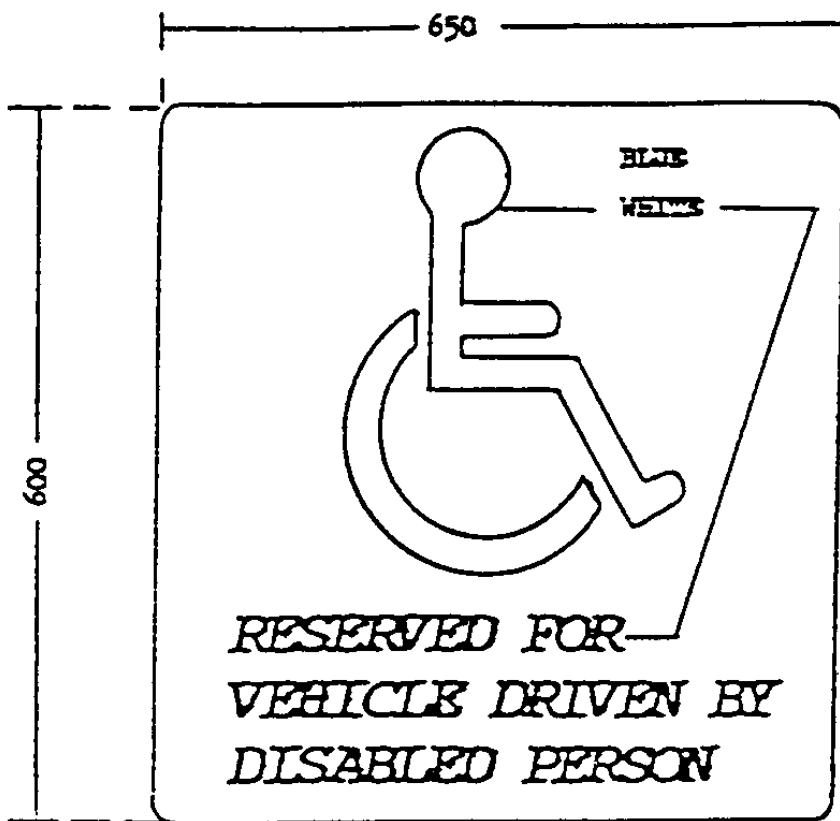

This sign indicates that the parking lot is reserved for a vehicle driven by a disabled person.

[Diagrams 158 and 159 deleted by S 461/98]

THE SCHEDULE — *continued*

DIAGRAM 160 (a)

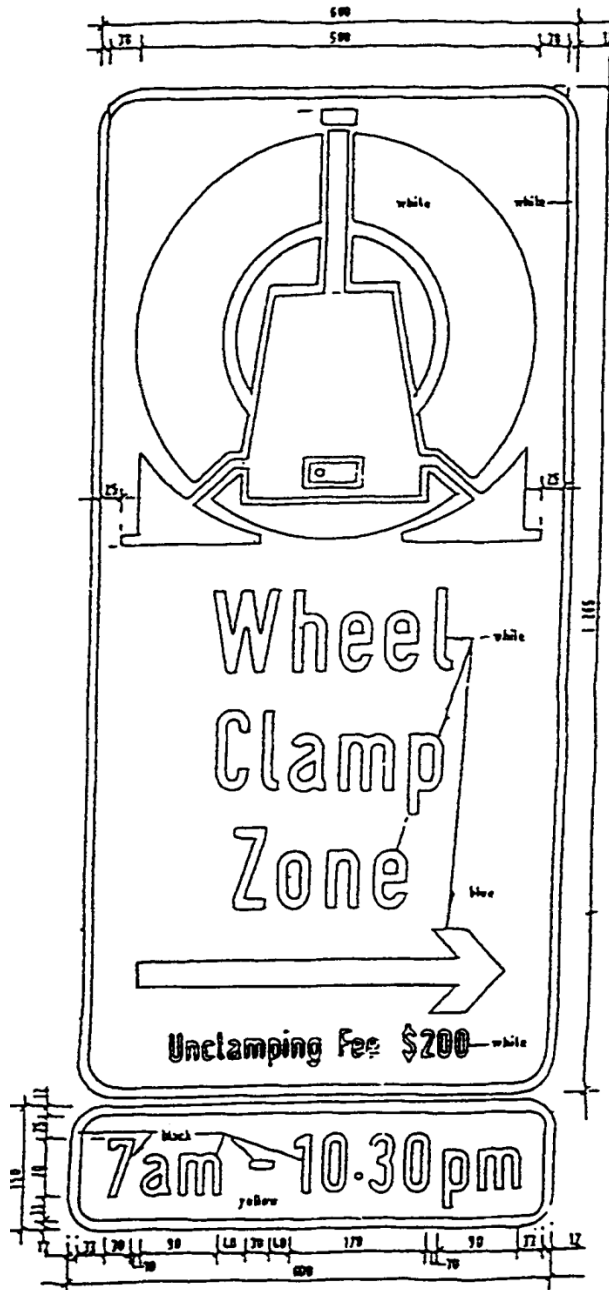

THE SCHEDULE — continued

DIAGRAM 160 (b)

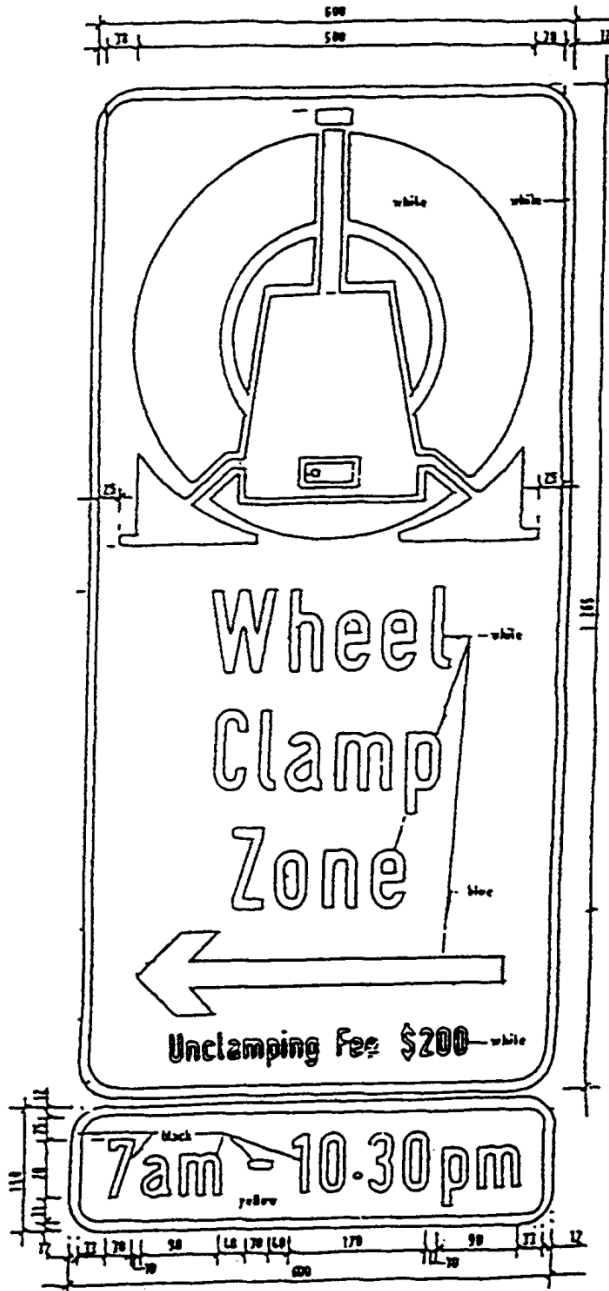

THE SCHEDULE — *continued*

DIAGRAM 160 (c)

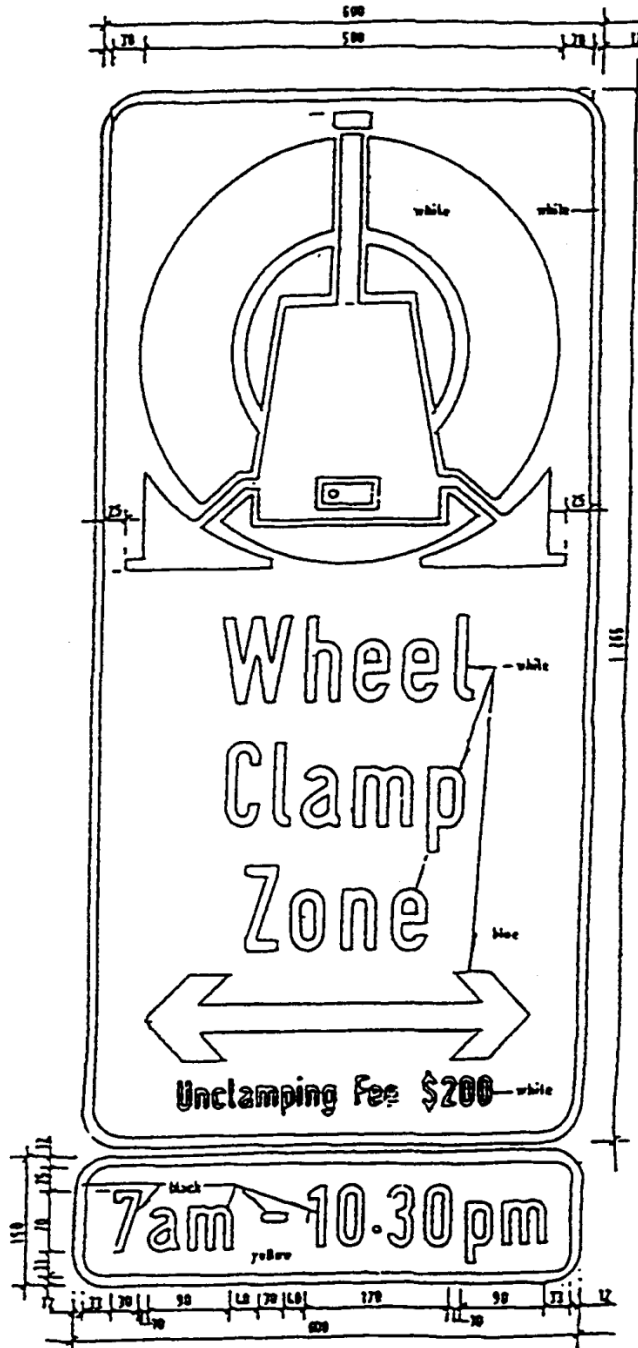

THE SCHEDULE — continued

DIAGRAM 160 (d)

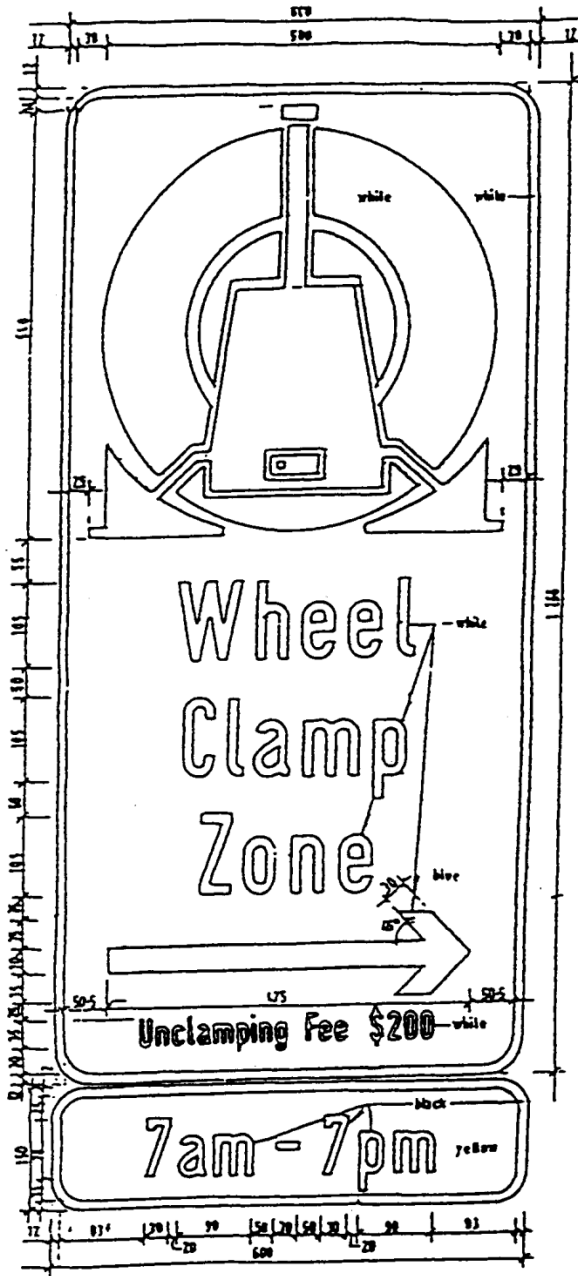

THE SCHEDULE — *continued*

THE SCHEDULE — *continued*

THE SCHEDULE — *continued*

THE SCHEDULE — *continued*

THE SCHEDULE — *continued*

— continued

DIAGRAM 160 (e)

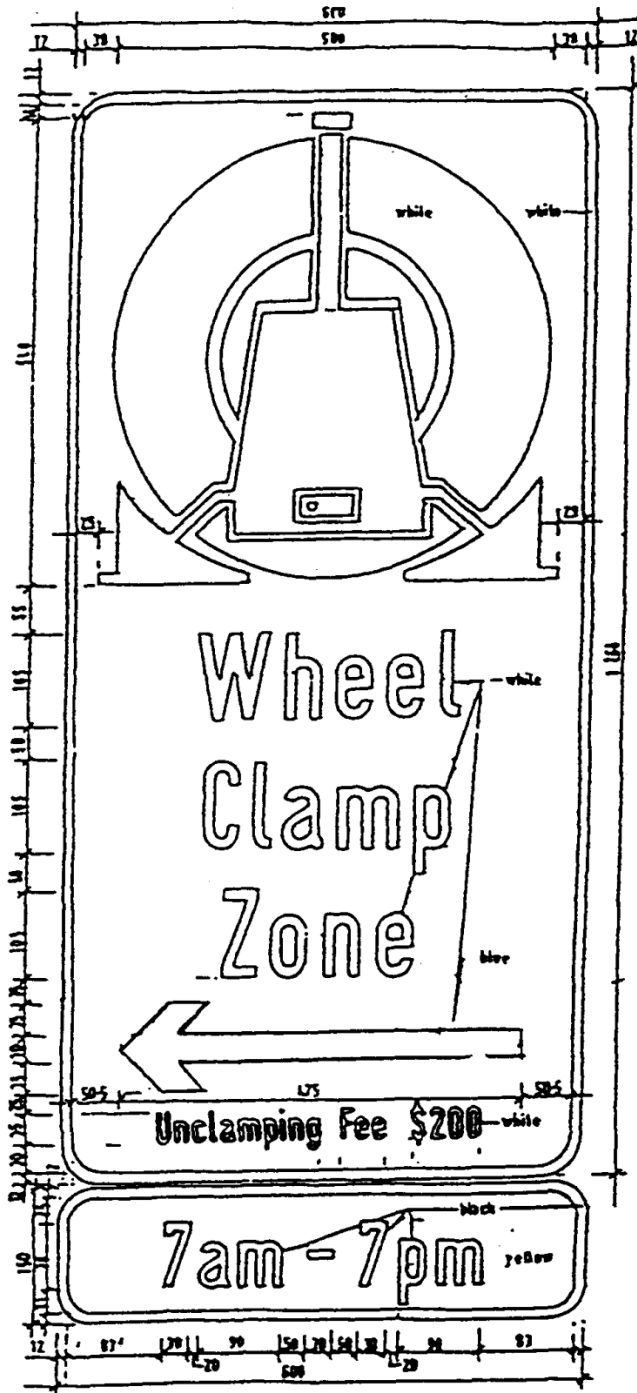

THE SCHEDULE — *continued*

DIAGRAM 160 (f)

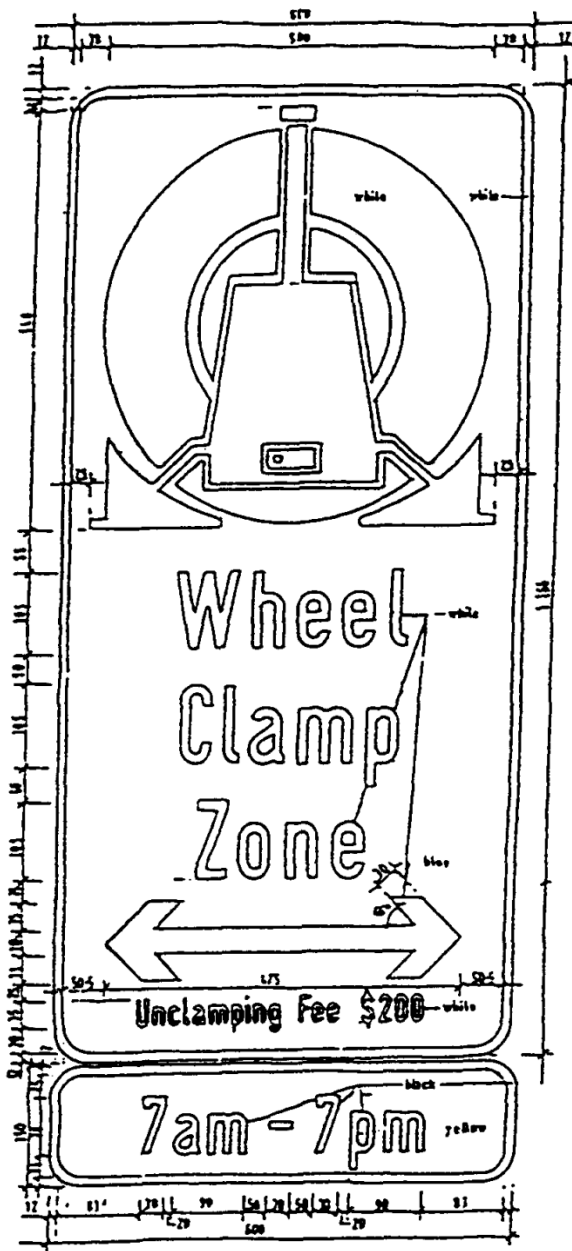

THE SCHEDULE — continued

DIAGRAM 161 (a)

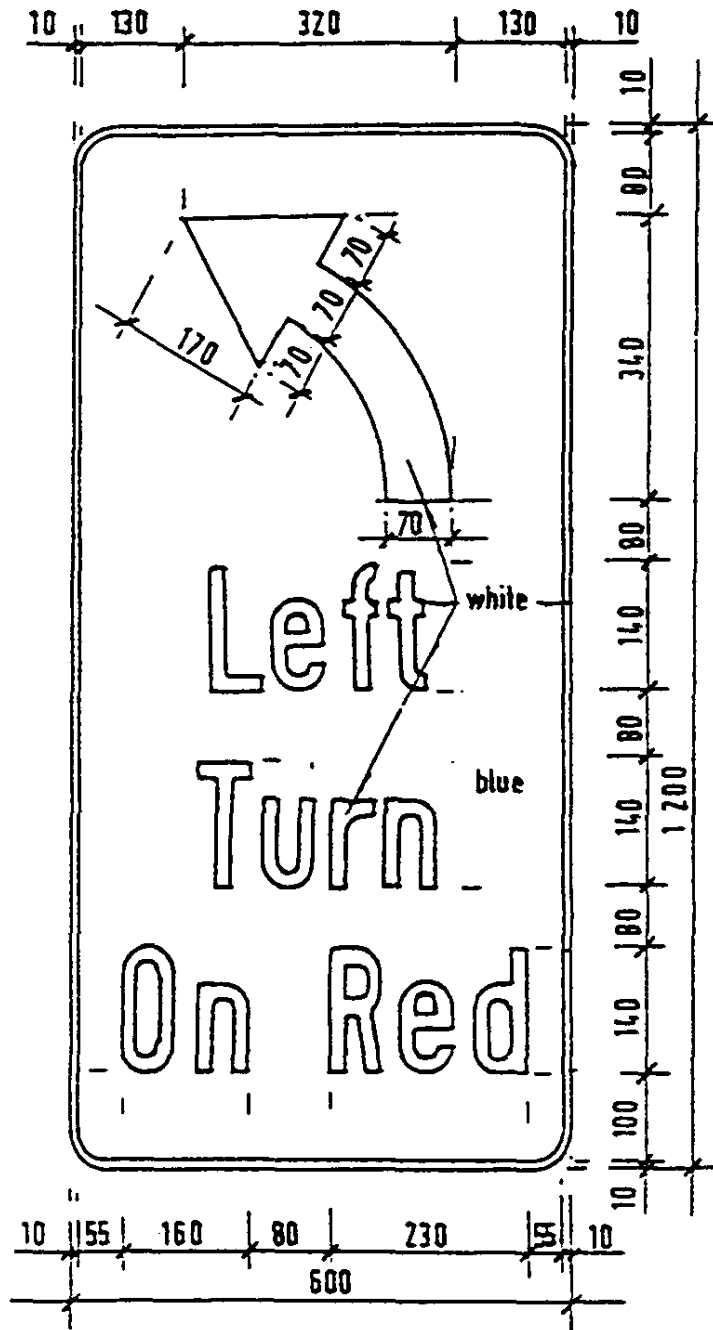

THE SCHEDULE — continued

DIAGRAM 161 (b)

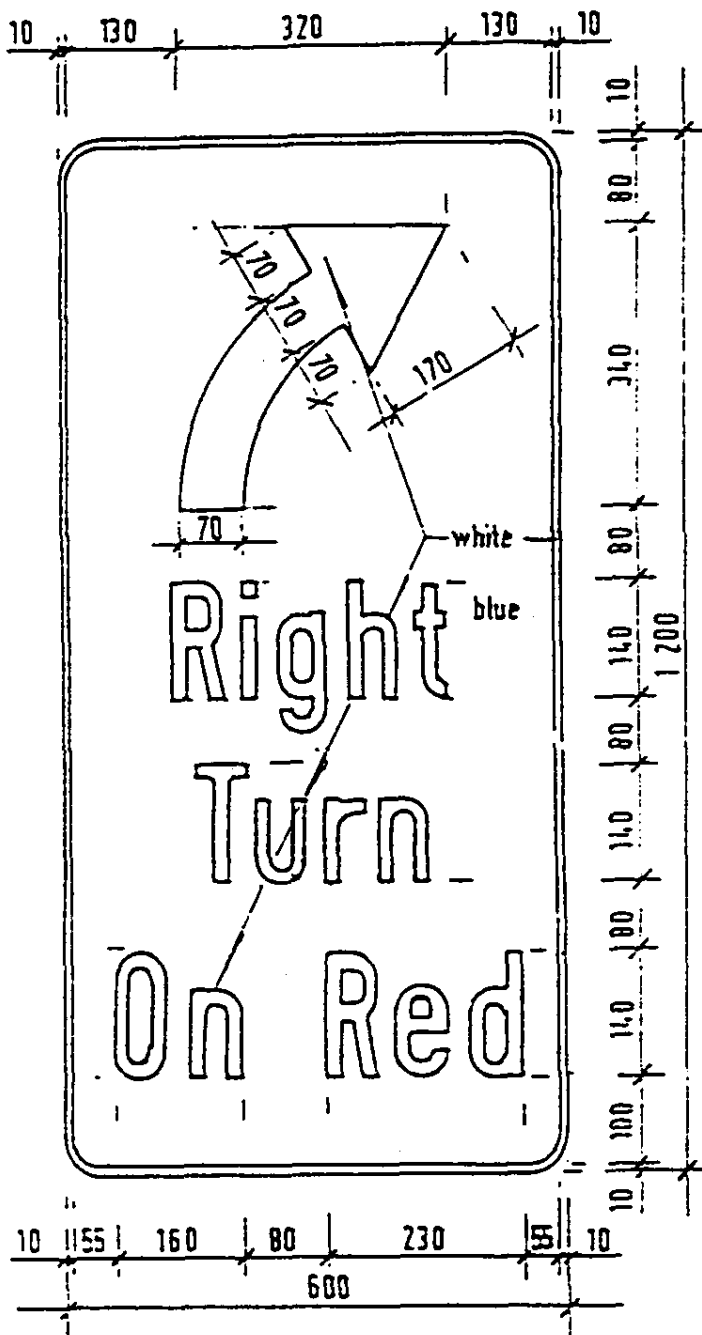

THE SCHEDULE — continued

DIAGRAM 161 (c)

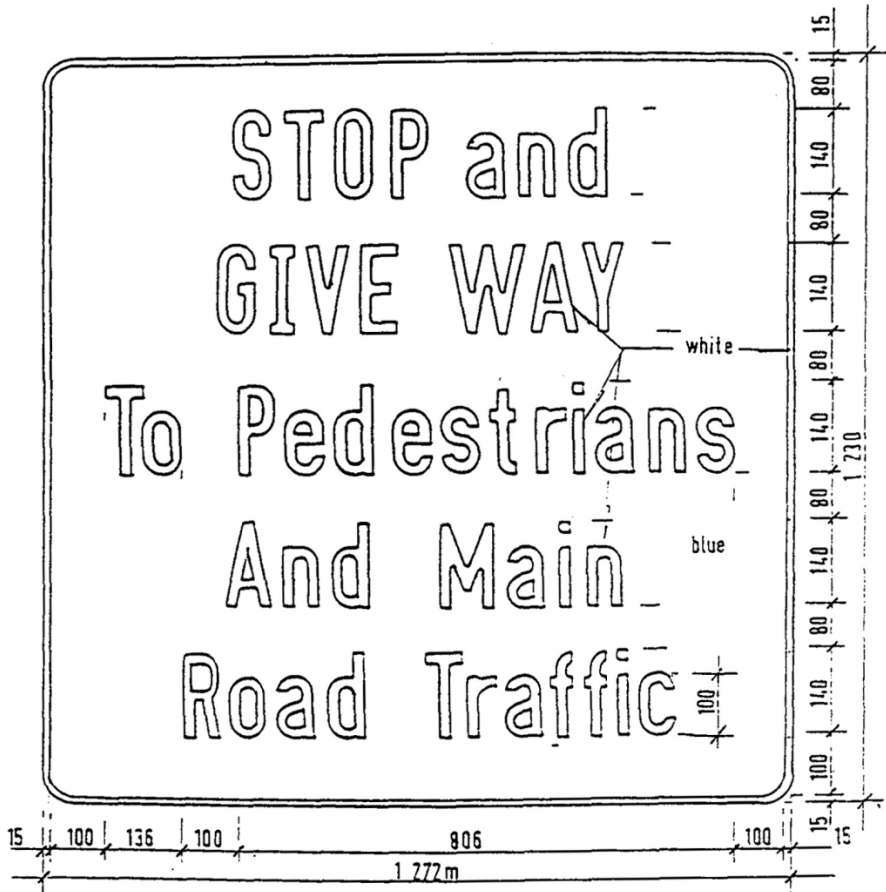

THE SCHEDULE — *continued*

DIAGRAM 161 (d)

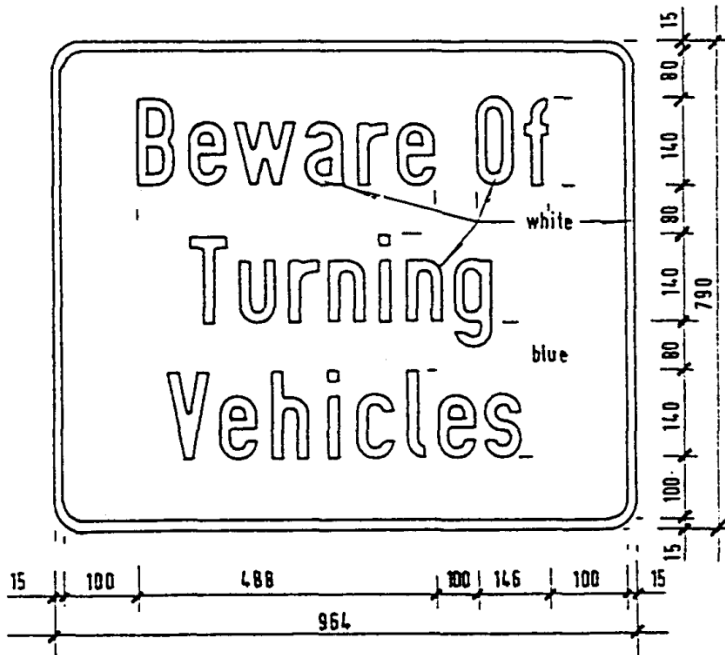
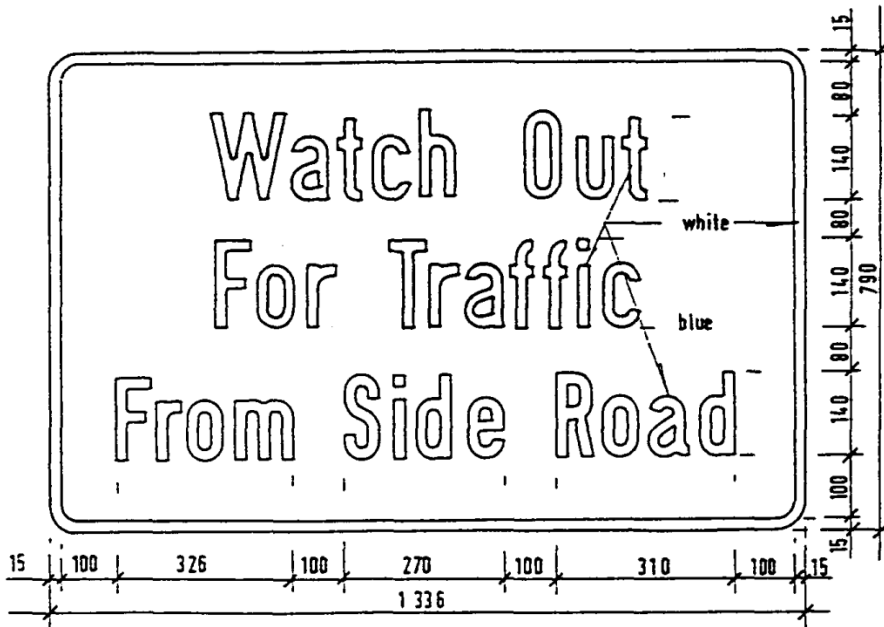
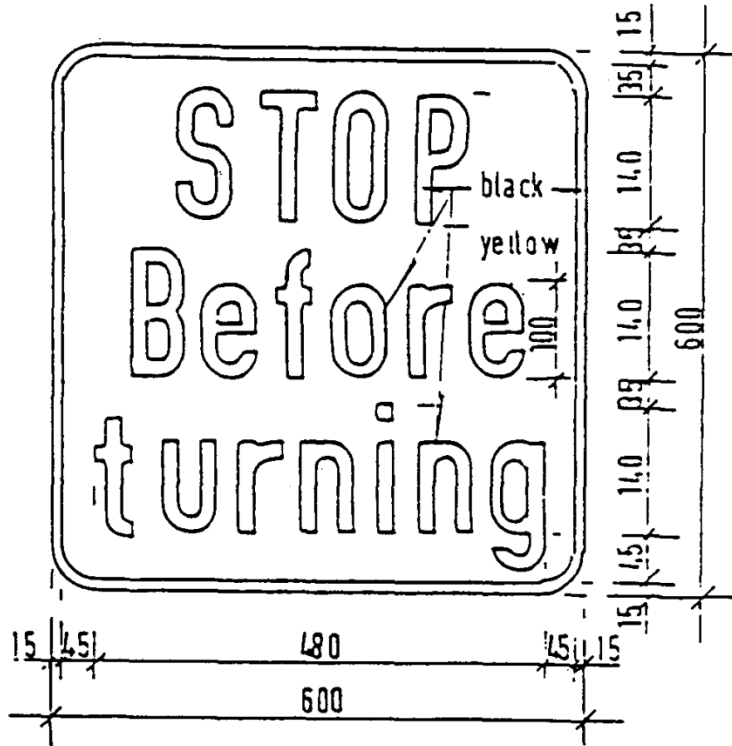

DIAGRAM 161 (e)



THE SCHEDULE — continued

DIAGRAM 161 (f)



THE SCHEDULE — *continued*

DIAGRAM 161 (g)

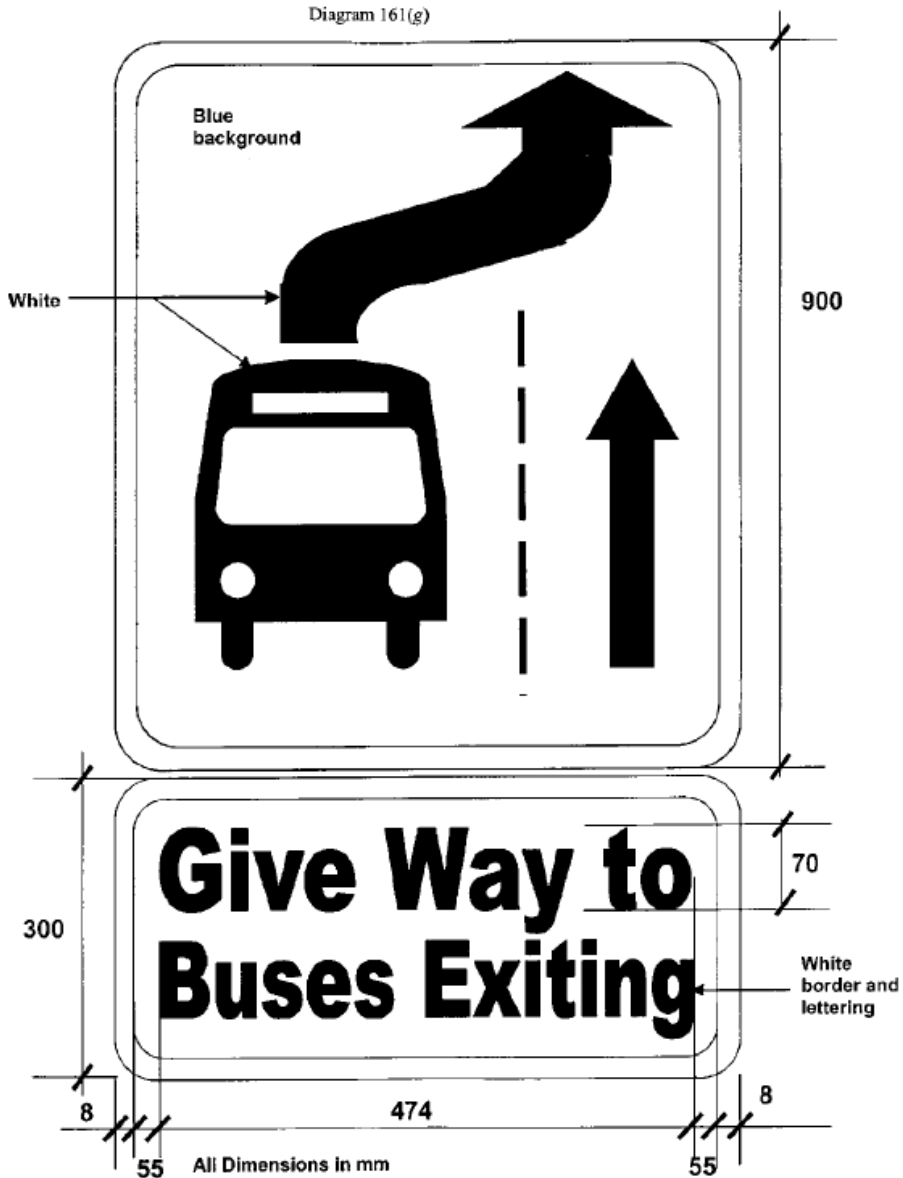

[S 3/2005 wef 03/01/2005]

THE SCHEDULE — *continued*

DIAGRAM 162

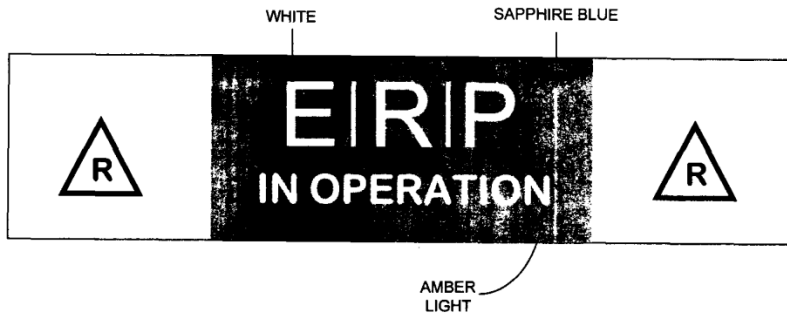
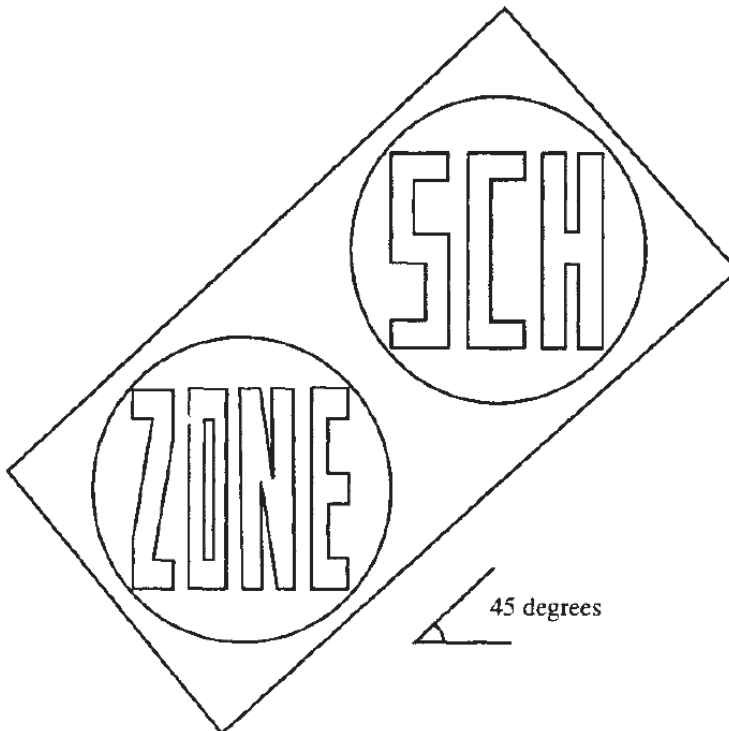

DIAGRAM 163



JUMPING AMBER LIGHTS

The jumping amber lights will flash alternately between the words “SCH” and “ZONE” to indicate to motorists that they are approaching a school zone and they should slow down and drive carefully with regard to school children crossing

THE SCHEDULE — *continued*

the roads.

[S 83/2000 wef 01/03/2000]

DIAGRAM 164

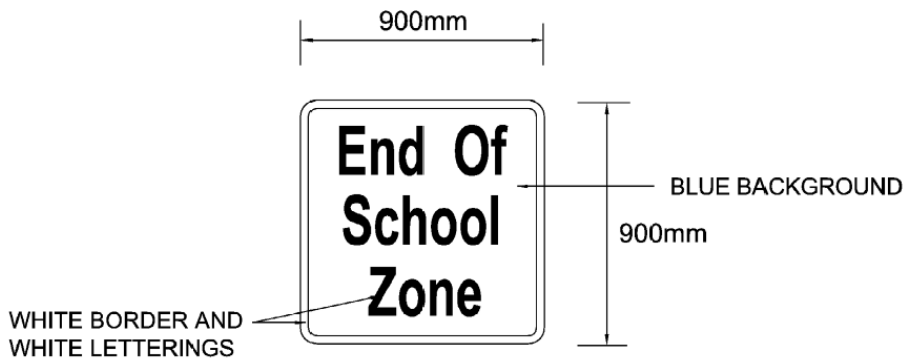

END OF SCHOOL ZONE

This sign is placed at the end of a demarcated school zone. It indicates that the section of the road before fronts a school.

[S 782/2013 wef 01/01/2014]

DIAGRAM 165

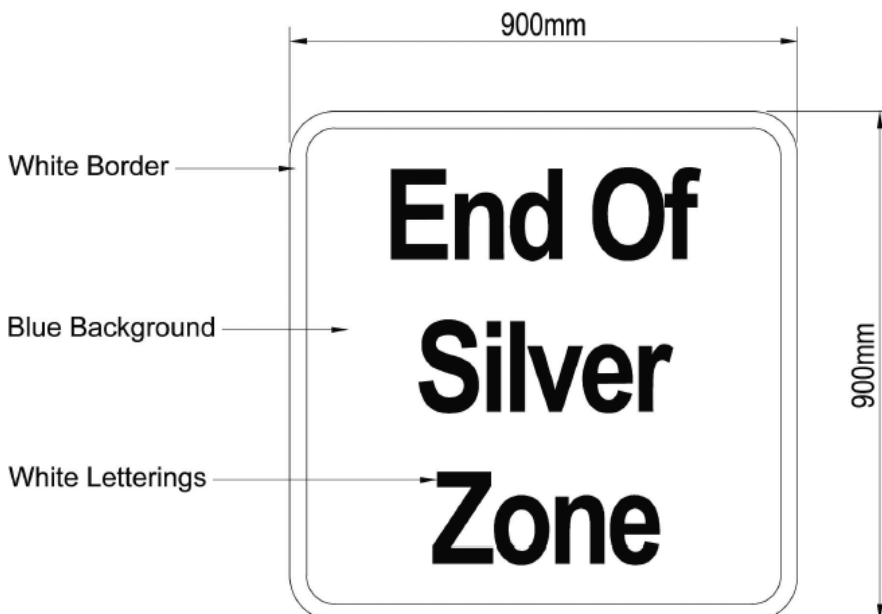

THE SCHEDULE — *continued*

END OF SILVER ZONE

This sign is placed at the end of a demarcated silver zone. It indicates that elderly pedestrians are likely to be encountered in the section of road before.

DIAGRAM 166

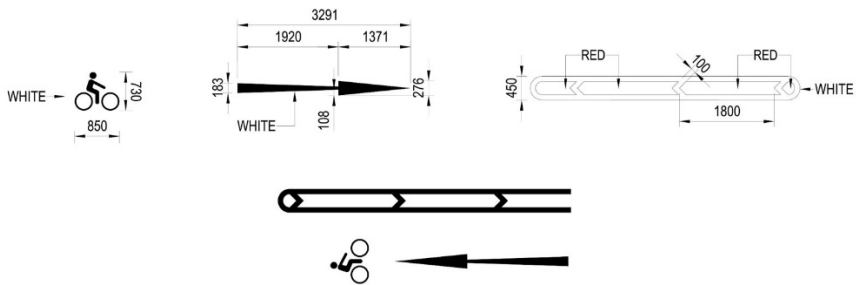

Markings indicating a bicycle lane.

DIAGRAM 167(a)

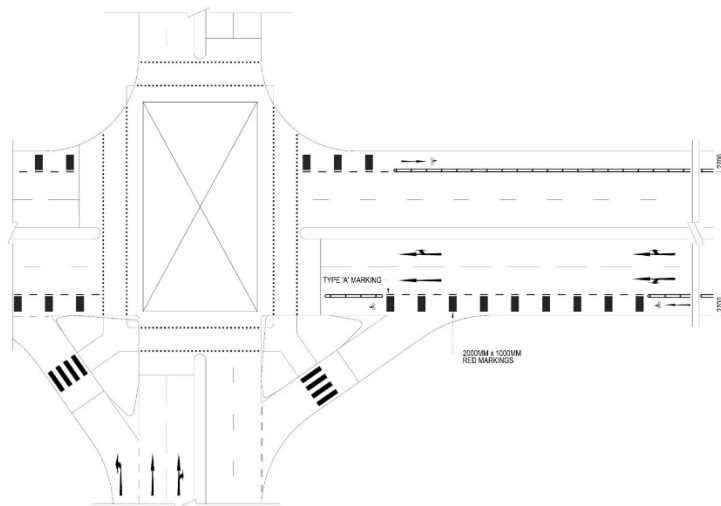

A bicycle lane at a signalised intersection.

DIAGRAM 167(b)

THE SCHEDULE — *continued*

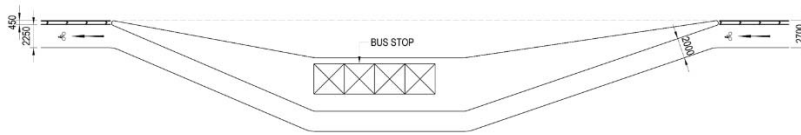

A bicycle lane at a bus stop.

BICYCLE LANES AT UNCONTROLLED JUNCTIONS OR OPENINGS

DIAGRAM 168(a)

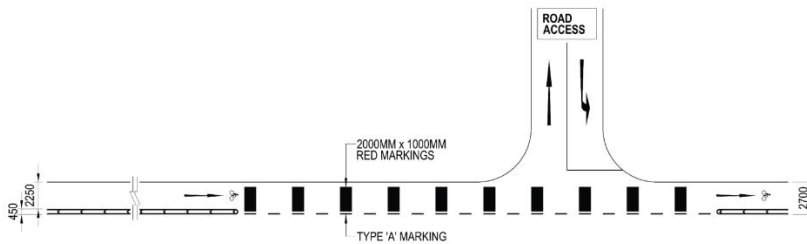

DIAGRAM 168(b)

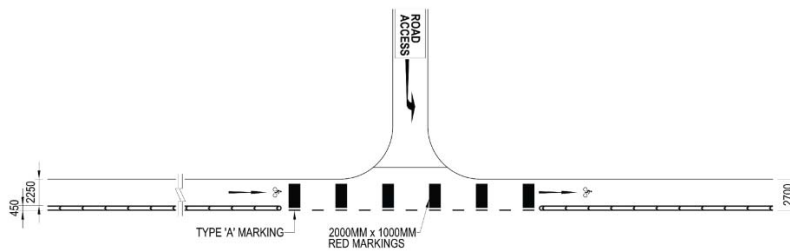

DIAGRAM 168(c)

THE SCHEDULE — *continued*

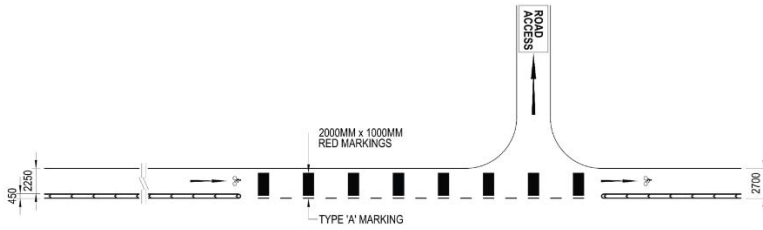

DIAGRAM 169



This sign indicates that cyclists are likely to be encountered in the section of road ahead, and that motorists should slow down.

DIAGRAM 170(a)

THE SCHEDULE — *continued*



This sign indicates the start of a bicycle lane.

DIAGRAM 170(b)

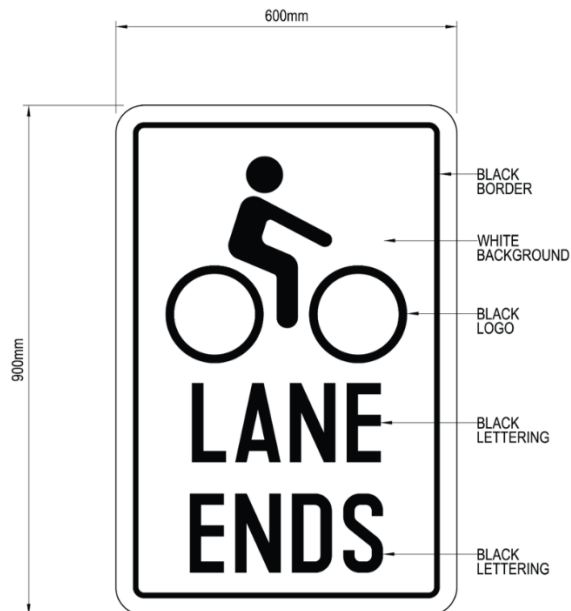

THE SCHEDULE — *continued*

This sign indicates the end of a bicycle lane.

[S 172/2017 wef 22/04/2017]

[S 670/2014 wef 01/10/2014]

*[G.N. Nos. S 501/91; S 442/92; S 540/93; S 341/94;
S 466/94; S 48/95; S 61/95; S 192/95; S 205/95; S 229/95;
S 538/95; S 171/96; S 319/96; S 196/97; S 223/97;
S 482/97; S 179/98; S 461/98; S 636/98; S 191/99]*

LEGISLATIVE HISTORY
ROAD TRAFFIC (TRAFFIC SIGNS) RULES
(CHAPTER 276, R 33)

This Legislative History is provided for the convenience of users of the Road Traffic (Traffic Signs) Rules. It is not part of these Rules.

- 1. G. N. No. S 501/1991 — Road Traffic (Traffic Signs) Rules 1991**
Date of commencement : 15 November 1991
- 2. 1990 Revised Edition — Road Traffic (Traffic Signs) Rules**
Date of operation : 25 March 1992
- 3. G. N. No. S 442/1992 — Road Traffic (Traffic Signs) (Amendment) Rules 1992**
Date of commencement : 23 October 1992
- 4. G. N. No. S 540/1993 — Road Traffic (Traffic Signs) (Amendment) Rules 1993**
Date of commencement : 3 January 1994
- 5. G. N. No. S 341/1994 — Road Traffic (Traffic Signs) (Amendment) Rules 1994**
Date of commencement : 9 September 1994
- 6. G. N. No. S 466/1994 — Road Traffic (Traffic Signs) (Amendment No. 2) Rules 1994**
Date of commencement : 15 December 1994
- 7. G. N. No. S 48/1995 — Road Traffic (Traffic Signs) (Amendment) Rules 1995**
Date of commencement : 11 February 1995
- 8. G. N. No. S 61/1995 — Road Traffic (Traffic Signs) (Amendment No. 2) Rules 1995**
Date of commencement : 18 February 1995
- 9. G. N. No. S 192/1995 — Road Traffic (Traffic Signs) (Amendment No. 3) Rules 1995**
Date of commencement : 24 April 1995
- 10. G. N. No. S 205/1995 — Road Traffic (Traffic Signs) (Amendment No. 4) Rules 1995**
Date of commencement : 2 May 1995

**11. G. N. No. S 229/1995 — Road Traffic (Traffic Signs) (Amendment No. 5)
Rules 1995**

Date of commencement : 1 June 1995

**12. G. N. No. S 538/1995 — Road Traffic (Traffic Signs) (Amendment No. 6)
Rules 1995**

Date of commencement : 1 December 1995

**13. G. N. No. S 171/1996 — Road Traffic (Traffic Signs) (Amendment)
Rules 1996**

Date of commencement : 19 April 1996

**14. G. N. No. S 319/1996 — Road Traffic (Traffic Signs) (Amendment No. 2)
Rules 1996**

Date of commencement : 19 July 1996

**15. G. N. No. S 196/1997 — Road Traffic (Traffic Signs) (Amendment)
Rules 1997**

Date of commencement : 16 April 1997

**16. G. N. No. S 223/1997 — Road Traffic (Traffic Signs) (Amendment No. 2)
Rules 1997**

Date of commencement : 5 May 1997

**17. G. N. No. S 482/1997 — Road Traffic (Traffic Signs) (Amendment No. 3)
Rules 1997**

Date of commencement : 31 October 1997

**18. G. N. No. S 179/1998 — Road Traffic (Traffic Signs) (Amendment)
Rules 1998**

Date of commencement : 1 April 1998

**19. G. N. No. S 461/1998 — Road Traffic (Traffic Signs) (Amendment No. 2)
Rules 1998**

Date of commencement : 1 September 1998

**20. G. N. No. S 636/1998 — Road Traffic (Traffic Signs) (Amendment No. 3)
Rules 1998**

Date of commencement : 1 January 1999

**21. G. N. No. S 191/1999 — Road Traffic (Traffic Signs) (Amendment)
Rules 1999**

Date of commencement : 14 April 1999

- 22. 1999 Revised Edition — Road Traffic (Traffic Signs) Rules**
Date of operation : 30 September 1999
- 23. G. N. No. S 13/2000 — Road Traffic (Traffic Signs) (Amendment) Rules 2000**
Date of commencement : 14 January 2000
- 24. G. N. No. S 83/2000 — Road Traffic (Traffic Signs) (Amendment No. 2) Rules 2000**
Date of commencement : 1 March 2000
- 25. G. N. No. S 375/2001 — Road Traffic (Traffic Signs) (Amendment) Rules 2001**
Date of commencement : 3 August 2001
- 26. G. N. No. S 549/2001 — Road Traffic (Traffic Signs) (Amendment No. 2) Rules 2001**
Date of commencement : 1 November 2001
- 27. G. N. No. S 334/2003 — Road Traffic (Traffic Signs) (Amendment) Rules 2003**
Date of commencement : 14 July 2003
- 28. G. N. No. S 3/2005 — Road Traffic (Traffic Signs) (Amendment) Rules 2005**
Date of commencement : 3 January 2005
- 29. G. N. No. S 572/2005 — Road Traffic (Traffic Signs) (Amendment No. 2) Rules 2005**
Date of commencement : 1 September 2005
- 30. G. N. No. S 577/2005 — Road Traffic (Traffic Signs) (Amendment No. 3) Rules 2005**
Date of commencement : 5 September 2005
- 31. G. N. No. S 639/2005 — Road Traffic (Traffic Signs) (Amendment No. 4) Rules 2005**
Date of commencement : 3 October 2005
- 32. G. N. No. S 134/2007 — Road Traffic (Traffic Signs) (Amendment) Rules 2007**
Date of commencement : 1 April 2007

33. G. N. No. S 651/2008 — Road Traffic (Traffic Signs) (Amendment) Rules 2008

Date of commencement : 20 December 2008

34. G. N. No. S 257/2009 — Road Traffic (Traffic Signs) (Amendment) Rules 2009

Date of commencement : 8 June 2009

35. G. N. No. S 165/2011 — Road Traffic (Traffic Signs) (Amendment) Rules 2011

Date of commencement : 29 March 2011

36. G. N. No. S 538/2011 — Road Traffic (Traffic Signs) (Amendment No. 2) Rules 2011

Date of commencement : 21 September 2011

37. G. N. No. S 814/2013 — Road Traffic (Traffic Signs) (Amendment No. 2) Rules 2013

Date of commencement : 29 December 2013

38. G. N. No. S 782/2013 — Road Traffic (Traffic Signs) (Amendment) Rules 2013

Date of commencement : 1 January 2014

39. G. N. No. S 670/2014 — Road Traffic (Traffic Signs) (Amendment) Rules 2014

Date of commencement : 1 October 2014

40. G.N. No. S 114/2016 — Road Traffic (Traffic Signs) (Amendment) Rules 2016

Date of commencement : 21 March 2016

41. G.N. No. S 676/2016 — Road Traffic (Traffic Signs) (Amendment No. 2) Rules 2016

Date of commencement : 1 January 2017

42. G.N. No. S 172/2017 — Road Traffic (Traffic Signs) (Amendment) Rules 2017

Date of commencement : 22 April 2017