

**ROAD TRAFFIC ACT
(CHAPTER 276, SECTIONS 34 AND 140)**

**ROAD TRAFFIC (MOTOR VEHICLES, REGISTRATION AND
LICENSING) RULES**

ARRANGEMENT OF RULES

PART I

PRELIMINARY

Rule

1. Citation
2. Definitions

PART II

REGISTRATION OF MOTOR VEHICLES

3. Application for registration
- 3A. Waiver of registration
- 3B. Registration of motor vehicles on Pulau Ubin
- 3C. Registration of light goods vehicles and small buses
- 3D. Pre-registration approval of vehicle
- 3E. Vehicle approval code
- 3F. Registration of replacement vehicle
4. Vehicle to be produced for inspection
- 4A. Vehicle testing for vehicles which cease to be tax exempt
5. Vehicles which are more than 3 years
6. Fee payable on registration
7. Additional registration fee
8. Rebate on additional registration fee
- 8A. Circumstances when rebate payable in cash
9. Rebate for off-peak car
- 9A. Rebate for electric car, petrol-electric car, new electric taxi and new petrol-electric taxi
- 9AA. Rebate for electric vehicle and petrol-electric vehicle
- 9B. Rebate for environmentally-friendly motor vehicle
- 9C. Carbon emissions rebate for new or secondhand car or taxi registered on or after 1st January 2013
10. Vehicular emissions rebate for new or secondhand car or taxi registered on or after 1 January 2018

Rule

- 11. [Deleted]
- 12. Register of vehicles
- 12A. Change of registration particulars to be notified
- 12B. Modification of registered vehicles
- 13. Search fee

PART III

INDEX AND IDENTIFICATION MARKS

- 14. Index mark
- 15. Application for cancellation of assigned index mark
- 16. Applications for particular index marks and registration numbers
- 16A. Applications for Registrar to assign index marks and registration numbers for existing motor vehicles
- 17. Identification mark
- 18. Position of identification mark
- 19. Identification mark not to be obstructed
- 20. Identification marks on trailers, etc.
- 21. Illumination of identification mark
- 22. Assignment of identification mark
- 23. [Deleted]
- 24. Tampering with seals

PART IV

TRANSFER OF VEHICLES

- 25. Transfer of vehicle registration
- 26. Temporary transfer of vehicle to finance firm or company or insurer, etc.
- 27. Transfer of business service passenger vehicle
- 28. Heavy vehicle not to be transferred without vehicle parking certificate
- 29. Transfer on death of owner
- 30. Transfer fee
- 31. Sums payable upon transfer of vehicle registration
- 31A. Sale or disposal of certain vehicles

PART V

REGISTRATION AND RE-REGISTRATION OF OFF-PEAK AND ELECTRIC
CARS, ETC.

Rule

- 32. Registration of off-peak cars
- 33. Re-registration before 25th January 2010 of private motor cars as off-peak cars and vice versa
- 33A. [*Deleted*]
- 33B. Re-registration of conventional cars as electric cars, petrol-electric cars or diesel-electric cars
- 33C. Re-registration of petrol-electric cars or diesel-electric cars as electric cars
- 33D. Re-registration of business service passenger vehicles as private motor cars or tuition cars
- 33E. Re-registration on or after 25th January 2010 of private motor cars, etc., as off-peak cars
- 33F. Re-registration on or after 25th January 2010 of off-peak cars as private motor cars or business service passenger vehicles
- 33G. Rebate for secondhand off-peak car registered on or after 1st July 2010
- 33H. Re-registration of private hire cars as business service passenger vehicles or private motor cars and vice versa
- 34. Vehicle destroyed, exported or ceased to be kept or used
- 34A. Keeping of de-registered vehicles in designated areas
- 34B. Keeping of de-registered vehicles in approved private areas and compounds
- 34C. Keeping of unregistered vehicles in approved private areas and compounds
- 34D. Keeping of de-registered original vehicle prior to destruction or export

PART VI

LICENCES

- 35. Application for licence
- 36. Period of motor vehicle licence
- 36A. Licence fee for electric car
- 36B. Licence fee for petrol-electric car and diesel-electric car
- 36C. Licence fee for buses, goods vehicles and goods-cum-passengers vehicles which are CNG vehicles,

petrol-CNG vehicles, diesel-CNG vehicles, electric vehicles, or
petrol-electric vehicles or diesel-electric vehicles

Rule

- 36D. Licence fee for electric motor cycles and electric scooters
- 36E. Licence fee for CNG car, petrol-CNG car and diesel-CNG car
- 37. Additional licence fee
- 38. Licence for off-peak car and supplementary licence
- 38A. Licence for classic vehicle and supplementary licence
- 38B. Licence for PU-registered vehicles
- 38C. Rebate for applicable vehicles with licences issued before
25 June 2017 and valid on or after 1 August 2017
- 39. Conditions for issue and renewal of licence
- 40. Individual may register motor car as business service passenger
vehicle or private motor car
- 41. Motor vehicle unfit or unsuitable for service
- 41A. Transfer of licence to replacement vehicle

PART VII

WEIGHT, MARKINGS AND SEATING CAPACITY

- 42. Maximum laden weight
- 43. Maximum laden weight of motor vehicle
- 44. Maximum laden weight of trailer
- 45. Markings
- 45A. Markings on plate
- 45B. Marking of maximum speed
- 45C. Markings on light goods vehicles and small buses
- 45D. CNG identification marking
- 45E. CNG system information marking
- 46. Prohibition
- 47. Determination of seating capacity

PART VIII

EXEMPTION FROM PAYMENT OF TAXES OR FEES

- 48. [*Deleted*]
- 49. [*Deleted*]
- 50. [*Deleted*]
- 51. [*Deleted*]
- 52. Claims to exemption
- 53. Non-user

Rule

54. Replacement engine or electric traction motors

PART IX

SUPPLEMENTARY LICENCES

55. Issue of electronic supplementary licences for off-peak cars
55A. Classic vehicle supplementary licences
55B. Restricted vintage vehicle and revised use vintage vehicle
supplementary licences
56. Validity and display of supplementary licences

PART X

VISITOR'S PERMITS

57. Visitor's permits
57A. Visitor's permit to be carried
57B. Display of visitor's permit
57C. Illegible visitor's permit not to be exhibited

PART XI

GENERAL LICENCES

58. Application for general licence
59. General licence plates
60. Position of plates and licence
60A. Approval to use general licence upon foreign vehicle
60B. Furnishing of false or misleading information or documents
61. Use of vehicle under general licence by person other than holder
of licence
62. Limitation of use
63. [*Deleted*]
64. Fees for general licence

PART XII

SPECIAL PURPOSE LICENCES

- 64A. Application for special purpose licence
64B. Special purpose licences

PART XIII

DUPLICATE LICENCE OR PERMIT, REFUNDS AND DISPOSAL OF
DEPOSITS

Rule

- 64C. Duplicate licence or permit
- 65. Refunds
- 66. Disposal of deposits
- 67. Fee payable when vehicle ceases to be exempted

PART XIV

AMENDMENT OR WITHDRAWAL OF APPLICATIONS

- 68. Amendment or withdrawal of applications

PART XV

REGISTRATION AND RE-REGISTRATION OF CLASSIC VEHICLES,
NORMAL VINTAGE VEHICLES, RESTRICTED VINTAGE VEHICLES AND
REVISED USE VINTAGE VEHICLES

- 69. Registration or re-registration of motor vehicles as classic vehicles
 - 70. Registration of motor vehicles as normal vintage vehicles or revised use vintage vehicles
 - 71. Re-registration of normal vintage vehicles to allow for transfer
 - 72. Re-registration of restricted vintage vehicles as normal vintage vehicles
 - 73. Re-registration of normal vintage vehicles or restricted vintage vehicles as revised use vintage vehicles
 - 74. Re-registration of revised use vintage vehicles as normal vintage vehicles
- The Schedules

[15th September 1972]

PART I

PRELIMINARY

Citation

1. These Rules may be cited as the Road Traffic (Motor Vehicles, Registration and Licensing) Rules.

Definitions

2.—(1) In these Rules, unless the context otherwise requires —

“business service passenger vehicle” means a motor car registered in the name of —

- (a) a statutory board, company, firm, society, club or an association and is used for the owner’s business; or
- (b) an individual and is used for the purpose of any trade, business, profession or vocation,

but does not include a private hire car or a motor car used —

- (i) for the carriage of goods other than samples;
- (ii) for the carriage of passengers for hire or reward; or
- (iii) for instructional purposes for reward unless prior approval of the Registrar has been obtained;

“car-sharing co-operative” means a co-operative society (not being a business connected with the manufacturer, sale or dealership of motor vehicles) which is registered under the Co-operative Societies Act (Cap. 62) and which has as its object the purchase of vehicles for the shared use of its members and affiliates for their business, social or domestic purposes;

“category (f) certificate of entitlement” means a certificate of entitlement issued under rule 3(1)(f) of the Road Traffic (Motor Vehicles, Quota System) Rules (R 31);

“chauffeured private hire car” means a private hire car hired, or made available for hire, for use primarily in the circumstances in paragraph (b) of the definition of “private

hire car” but which may also be used in the circumstances in paragraph (a) of that definition;

[S 550/2017 wef 01/10/2017]

“classic vehicle” means a motor car, motor cycle or scooter that is at least 35 years old when it is registered or re-registered as a classic vehicle under rule 69, and includes any vehicle which, before 1st August 2012 is registered as a classic car in the register of motor vehicles maintained by the Registrar under rule 12;

“CNG system” means an assembly of components and connecting parts which are fitted on —

- (a) a CNG vehicle;
- (b) a diesel-CNG vehicle; or
- (c) a petrol-CNG vehicle,

to enable the vehicle to use natural gas as its source of power;

“CNG vehicle” means a vehicle which uses natural gas exclusively as its source of power;

“conventional car” means a motor car that is mechanically propelled by means of internal combustion engines;

“cylinder capacity” means —

- (a) the area of the piston crown of the cylinder of the engine multiplied by the stroke multiplied by the number of cylinders of the engine; or
- (b) the volume swept by the piston in the cylinder multiplied by the number of cylinders of the engine,

and the product so derived is expressed in cubic centimetres;

“de-registered”, in relation to a vehicle, means that the registration of the vehicle has been cancelled;

“diesel-CNG vehicle” means a vehicle which uses either or both natural gas and diesel as its source of power;

“diesel-electric car” means a motor car which uses either or both diesel and electricity as its source of power;

“diesel-electric vehicle” means a vehicle, other than a motor car, which uses either or both diesel and electricity as its source of power;

“electric car” means a motor car that is mechanically propelled by means of electric traction motors;

“electric motor cycle” or “electric scooter” means a motor cycle or scooter, respectively, that is mechanically propelled by means of electric traction motors;

“electric vehicle” means a vehicle, other than a car, that is mechanically propelled by means of electric traction motors;

“Euro IV standard” means —

- (a) in relation to a diesel driven motor car, a standard for exhaust emission which complies with the standard specified in row B of the table referred to in paragraph 13 of the Annex to Directive 98/69/EC of the European Parliament and of the Council of the European Union;
- (b) in relation to a diesel driven motor vehicle (other than a motor car) with gross vehicle weight not exceeding 3.5 tons, a standard for exhaust emission which complies with the standard specified in row B of the table referred to in paragraph 13 of the Annex to Directive 98/69/EC of the European Parliament and of the Council of the European Union; or
- (c) in relation to a diesel driven motor vehicle (other than a motor car) with gross vehicle weight exceeding 3.5 tons, a standard for exhaust emission which complies with the standard specified in row B1 of Table 1 or row B1 of Table 2 contained in the Annex to Directive 1999/96/EC of the European Parliament and of the Council of the European Union;

“Euro V standard”, in relation to any vehicle, means a standard for exhaust emission which complies with the standard specified in Table 1 of Annex I of Regulation (EC)

No. 715/2007 of the European Parliament and of the Council of the European Union;

“foreign vehicle” means any motor vehicle which is not registered under the Act, but which is registered under the provisions of any law of any country (other than Singapore) relating to motor vehicles;

“goods-cum-passengers vehicle” means —

- (a) a station wagon constructed for the carriage of 7 passengers or more, excluding the driver, and registered by the owner for the use by him or a member of his family or any person by his authority without consideration for social or domestic purposes or for the owner’s business and excluding the use for instructional purposes for reward;
- (b) a panel van; or
- (c) a twin-cabin goods vehicle;

“heavy goods vehicle” means —

- (a) a goods vehicle, construction equipment, engineering plant, trivan, motor cycle with a side-car attached to it, recovery vehicle, vehicle used as a mobile canteen or mobile bank, goods-cum-passengers vehicle or a vehicle used for a specific purpose such as a horse float, the maximum laden weight of which exceeds 3.0 metric tons and which is registered using a certificate of entitlement issued before 1st April 1998; or
- (b) a goods vehicle, construction equipment, engineering plant, trivan, recovery vehicle, vehicle used as a mobile canteen or mobile bank, goods-cum-passengers vehicle or a vehicle used for a specific purpose such as a horse float, the maximum laden weight of which exceeds 3.5 metric tons and which is registered using a certificate of entitlement issued on or after 1st April 1998;

“heavy oil or diesel oil” includes any liquid other than petroleum which is or may be used as fuel in the engine of a motor vehicle;

“JPN 2009 standard”, in relation to any vehicle, means a standard for exhaust emission which complies with the standard specified in Article 41 of the Japanese Ministry of Land, Infrastructure and Transport Announcement No. 619 dated 15th July 2002 (Announcement That Prescribes Details of Safety Regulations for Road Vehicles), as amended by the Japanese Ministry of Land, Infrastructure, Transport and Tourism Announcement No. 68 dated 25th January 2013;

“light goods vehicle” means —

- (a) a goods vehicle, construction equipment, engineering plant, trivan, motor cycle with a side-car attached to it, recovery vehicle, vehicle used as a mobile canteen or mobile bank, goods-cum-passengers vehicle or a vehicle used for a specific purpose such as a horse float, the maximum laden weight of which does not exceed 3.0 metric tons and which is registered using a certificate of entitlement issued before 1st April 1998; or
- (b) a goods vehicle, construction equipment, engineering plant, trivan, motor cycle with a side-car attached to it, recovery vehicle, vehicle used as a mobile canteen or mobile bank, goods-cum-passengers vehicle or a vehicle used for a specific purpose such as a horse float, the maximum laden weight of which does not exceed 3.5 metric tons and which is registered using a certificate of entitlement issued on or after 1st April 1998;

“maximum power output” means —

- (a) in the case of a conventional vehicle or an electric vehicle, the maximum power output, expressed in kilowatts (kW), of the vehicle’s internal combustion engines or electric traction motors, as the case may be;

(b) in the case of a diesel-CNG vehicle or a petrol-CNG vehicle, the higher of the maximum power output, expressed in kilowatts (kW), of the vehicle using either of its sources of power; or

(c) in the case of a diesel-electric vehicle or a petrol-electric vehicle, the peak aggregate power output, expressed in kilowatts (kW), of the vehicle using both of its sources of power simultaneously;

“mobile engineering plant” has the same meaning as in rule 2 of the Road Traffic (Regulation of Speed) Rules (R 13);

“motor car” has the same meaning as in section 4(1)(e) of the Act;

“motor tractor” has the same meaning as in rule 2 of the Road Traffic (Regulation of Speed) Rules;

“new vehicle”, for the purposes of rules 3B, 7, 8, 8A, 9, 9A, 9AA, 9B, 9C and 10 and Part II of the First Schedule, means —

(a) a motor vehicle or trailer which —

(i) is first registered in a country or place outside Singapore and is subsequently de-registered within a period of 3 working days (excluding Saturdays, Sundays and public holidays), or such longer period as the Registrar may allow in any particular case, after that first registration;

(ii) is registered under these Rules on or after 1st June 2000 pursuant to an application made within 3 months (or such longer period as the Registrar may allow in any particular case) after de-registration in that country or place; and

(iii) has never been used anywhere before the date of its first registration in Singapore; or

- (b) any motor vehicle which has not been registered elsewhere before its first registration in Singapore;

[S 263/2021 wef 01/01/2013]

[S 263/2021 wef 01/01/2018]

“normal vintage vehicle” means a motor car, motor cycle or scooter in respect of which —

- (a) the Registrar is satisfied was manufactured before 1940; and
- (b) the levy under section 10A(2) of the Act is paid and which —
- (i) before 1st August 2012 is registered as a vintage vehicle in the register of motor vehicles maintained by the Registrar under rule 12;
- (ii) is registered as a normal vintage vehicle under rule 70; or
- (iii) is re-registered as a normal vintage vehicle under rule 71, 72 or 74;

“off-peak car” means a motor car which is registered under rule 32, or re-registered under rule 33 or 33E (as the case may be), as an off-peak car and which may not be driven on any road during the days and times specified in the Fifth Schedule unless there is in force a supplementary licence issued under Part IX for that vehicle;

“original vehicle” has the same meaning as in the Road Traffic (Motor Vehicles, Quota System) Rules;

“panel van” means a light goods vehicle having a body derived from a motor car with its sides panelled up and with a design similar to a station wagon (saloon model) or a jeep;

“petrol-CNG vehicle” means a vehicle which uses either natural gas or petrol as its source of power;

“petrol-electric car” means a motor car which uses either or both petrol and electricity as its source of power;

“petrol-electric vehicle” means a vehicle, other than a car, which uses either or both petrol and electricity as its source of power;

“private hire car” means a motor car that does not ply for hire on any road, and —

- (a) is hired or made available for hire, under a contract (express or implied) for use as a whole by the hirer or any other individual authorised by the hirer in the contract to drive the car personally; or
- (b) is hired or made available for hire, under a contract (express or implied) for use as a whole with a driver for the purpose of conveying the hirer, and one or more passengers (if any), in that car;

[S 550/2017 wef 01/10/2017]

“private motor car” means a motor car registered in the name of —

- (a) a private individual and used by him or a member of his family or any person by his authority without consideration for social or domestic purposes or for his business;
- (b) a charitable organisation, whose income is exempt from tax under the Income Tax Act (Cap. 134) and which is a full member of the National Council of Social Service established under the National Council of Social Service Act (Cap. 195A) and used solely for the owner’s business; or
- (c) a car-sharing co-operative,

excluding the carriage of goods other than samples and excluding the use for instructional purposes for reward;

“power rating” means the maximum aggregate power output, expressed in kilowatts (kW), of the electric traction motors;

“public bus services contract” has the same meaning as in section 2 of the Bus Services Industry Act 2015 (Act 30 of 2015);

[S 327/2017 wef 25/06/2017]

“PU-registered vehicle” means a motor vehicle which is registered under rule 3B;

“register of vehicles” means the register maintained under rule 12;

“registered owner” means a person registered under the Act as owner of a motor vehicle;

“restricted vintage vehicle” means a motor car, motor cycle or scooter in respect of which —

- (a) the Registrar is satisfied was manufactured before 1940;
- (b) the levy under section 10A(2) of the Act is not paid; and
- (c) before 1st August 2012 is registered as a vintage vehicle in the register of motor vehicles maintained by the Registrar under rule 12;

“revised use vintage vehicle” means a motor car, motor cycle or scooter in respect of which —

- (a) the Registrar is satisfied was manufactured before 1940;
- (b) the levy under section 10A(2) of the Act is paid; and
- (c) is registered as a revised use vintage vehicle under rule 70 or re-registered as a revised use vintage vehicle under rule 73;

“secondhand vehicle”, for the purposes of rules 3D, 7, 8, 8A, 9A, 9AA, 9C, 10 and 33G and Part II of the First Schedule, means a vehicle which has been registered or used in a country or place outside Singapore before the date of its first registration in Singapore unless the vehicle —

- (a) was de-registered within a period of 3 working days (excluding Saturdays, Sundays and public holidays), or such longer period as the Registrar may allow in any particular case, after its first registration in that country or place;
- (b) is registered under these Rules on or after 1st June 2000 pursuant to an application made within 3 months (or such longer period as the Registrar may allow in any particular case) after that de-registration outside Singapore; and
- (c) has never been used anywhere before the date of its first registration in Singapore;

[S 263/2021 wef 01/01/2013]

[S 263/2021 wef 01/01/2018]

“self-drive private hire car” means a private hire car hired, or made available for hire, in the circumstances in paragraph (a) of the definition of “private hire car”;

[S 550/2017 wef 01/10/2017]

“small bus” means a bus having a maximum seating capacity of 10 persons (including the driver) or less;

“station wagon” means a vehicle with folding seats and side doors and either a tailboard or doors opening at the rear, constructed or adapted for the carriage of goods as well as passengers;

“station wagon (passengers only)” means a station wagon registered by the owner for the use by him or a member of his family or any person by his authority without consideration for social or domestic purposes or for the owner’s business, excluding the carriage of goods other than samples and excluding the use for instructional purposes for reward;

“tuition car” means a motor car that is used in the course of its owner’s business for instructional purposes for reward;

“twin-cabin goods vehicle” means a goods vehicle with a maximum laden weight not exceeding 5.0 metric tons constructed with an additional cabin or enclosed space for

passengers or goods adjacent to or as an extension of the cabin for the driver and front seat passenger.

(2) For the purposes of these Rules, the age of a vehicle shall be reckoned —

(a) in the case of a vehicle which has not been registered outside Singapore before its first registration in Singapore, from the date of its first registration in Singapore;

(b) in the case of a vehicle which —

(i) is first registered outside Singapore; and

(ii) before the expiry of one month from the date of its first registration outside Singapore is first registered in Singapore,

from the date of its first registration in Singapore;

(c) in the case of a vehicle which —

(i) is first registered outside Singapore; and

(ii) after the expiry of one month from the date of its first registration outside Singapore is first registered in Singapore,

from the last day of the month of its first registration outside Singapore;

(d) in the case of a vehicle which —

(i) is first registered outside Singapore and is subsequently de-registered within a period of 3 working days thereafter (or such longer period as the Registrar may allow in any particular case);

(ii) is registered under these Rules on or after 1st June 2000 pursuant to an application made within 3 months (or such longer period as the Registrar may allow in any particular case) after that de-registration outside Singapore; and

(iii) has never been used anywhere before the date of its first registration in Singapore,

from the date of its first registration in Singapore;

- (e) where it is not possible to ascertain the date on which the vehicle was first registered in or outside Singapore, from the first day of its year of manufacture; and
- (f) where it is not possible to ascertain the date on which the vehicle was first registered in or outside Singapore and the year of its manufacture, from such date as the Registrar may, in his discretion, determine.

(3) In these Rules, a reference to registration as a private hire car is a reference to both registration as a chauffeured private hire car and registration as a self-drive private hire car.

[S 550/2017 wef 01/10/2017]

PART II

REGISTRATION OF MOTOR VEHICLES

Application for registration

3.—(1) The application of a person, or a motor firm on behalf of that person (referred to in this rule as the motor firm), desiring to be registered under the Act as the owner of a motor vehicle or a trailer shall be in such form as the Registrar may approve.

(2) Such form shall be —

- (a) fully and correctly completed by the applicant or motor firm and delivered to the Registrar; and
- (b) accompanied by the fees prescribed by these Rules.

(3) Every applicant or motor firm shall furnish such particulars and shall produce such evidence as may be required by the Registrar.

(4) [Deleted by S 125/2006]

(5) [Deleted by S 125/2006]

(6) [Deleted by S 125/2006]

(7) The Registrar may register a motor vehicle in the name of a car-sharing co-operative subject to such terms and conditions as he thinks fit.

(8) On receipt of an application under this rule, the Registrar may —

- (a) grant the application for registration; or
- (b) refuse to grant the application for registration.

Waiver of registration

3A. The Registrar may, in his discretion and subject to such conditions as he thinks fit, waive the registration of any vehicle if he is satisfied that —

- (a) the vehicle —
 - (i) will not be used on any road at any time; and
 - (ii) will be kept and used exclusively for any of the following purposes:
 - (A) training;
 - (B) research and development;
 - (C) exhibition for a duration not exceeding one month;
 - (D) racing within an enclosed area; or
- (b) the vehicle —
 - (i) will not be used on any road repairable at the public expense at any time; and
 - (ii) will not conform with the requirements of the Road Traffic (Motor Vehicles, Construction and Use) Rules (R 9).

Registration of motor vehicles on Pulau Ubin

3B.—(1) Subject to paragraph (2), the Registrar may, in his discretion, upon application in an approved form by the owner of a motor vehicle who —

- (a) resides in Pulau Ubin; or
- (b) operates a business in Pulau Ubin,

register or re-register the motor vehicle as a PU-registered vehicle.

(2) No vehicle shall be registered or re-registered as a PU-registered vehicle after 1st February 2001 unless it is a new vehicle or a vehicle which is already registered under the Act.

(3) Notwithstanding anything in these Rules, no vehicle shall be registered or re-registered as a PU-registered vehicle if its maximum laden weight exceeds 3 tonnes.

(4) The registration or re-registration of a motor vehicle as a PU-registered vehicle shall be subject to —

(a) the condition that the vehicle shall be kept and used only on Pulau Ubin; and

(b) such other conditions as the Registrar may impose.

(5) Any person who fails to comply with any condition referred to in paragraph (4) shall be guilty of an offence.

(6) No vehicle which is or has been registered as a PU-registered vehicle shall be re-registered as any other type of vehicle.

(7) [*Deleted by S 356/2010*]

Registration of light goods vehicles and small buses

3C.—(1) The Registrar shall not register any person as the owner of a light goods vehicle (other than a goods-cum-passengers vehicle) or a bus having a maximum seating capacity of 10 persons (including the driver) unless the Registrar is satisfied that the person —

(a) is —

(i) a person registered under the Business Registration Act (Cap. 32);

(ii) a company registered under the Companies Act (Cap. 50);

(iii) a statutory authority established under any written law;

(iv) the Government; or

(v) a person exempted from registration under section 4(1)(a) of the Business Registration Act

read with paragraphs 1 and 3(d) of the First Schedule to that Act; and

- (b) has complied or has undertaken to the Registrar to comply with rule 45C(1), (2) or (3), as the case may be.

(2) Notwithstanding paragraph (1), the Registrar may, in his discretion and subject to such conditions as he thinks fit, register any person not specified in paragraph (1) as the owner of a light goods vehicle (other than a goods-cum-passengers vehicle) or a bus having a maximum seating capacity of 10 persons (including the driver).

Pre-registration approval of vehicle

3D.—(1) No new or secondhand vehicle shall be registered under the Act unless —

- (a) in the case of a vehicle that is imported by a person other than the manufacturer of the vehicle or an authorised dealer, the vehicle has been granted batch type-approval; and
- (b) in any other case, the model of the vehicle has been granted type-approval or the vehicle has been granted batch type-approval.

(2) Where —

- (a) a new or secondhand vehicle is of a model which is modified after the model has been granted type-approval; or
- (b) a new or secondhand vehicle is of a model which has been granted type-approval but is manufactured in Singapore (whether wholly or partially),

the new or secondhand vehicle shall not be registered unless the modified model of the vehicle or the vehicle, as the case may be, has been granted modified type-approval.

(3) Any person who wishes to obtain batch type-approval, type-approval or modified type-approval in respect of a new or secondhand vehicle, a batch of new or secondhand vehicles or a

model of a new or secondhand vehicle shall apply to the Registrar for such approval.

(4) An application under paragraph (3) shall be accompanied by —

- (a) such information and documents as the Registrar may require;
- (aa) where the new vehicle, batch of new vehicles or model of a new vehicle falls within a class, description or type of motor vehicle to which Division 1 of Part IV of the Energy Conservation Act (Cap. 92C) applies, such information and documents relating to fuel economy and vehicular emissions as may be required to be submitted to the Registrar in respect of that class, description or type of motor vehicle under that Act;

[S 777/2017 wef 01/01/2018]

- (b) the appropriate application fee specified in Part IA of the First Schedule, in the case of an application for batch type-approval;
- (c) the appropriate application fee specified in Part IB of the First Schedule, in the case of an application for type-approval; and
- (d) the appropriate application fee specified in Part IC of the First Schedule, in the case of an application for modified type-approval.

(5) Where —

- (a) a new or secondhand vehicle does not comply with rule 6, 7, 8, 52, 56 or 99 of the Road Traffic (Motor Vehicles, Construction and Use) Rules (R 9);
- (b) a new or secondhand vehicle is one to which rule 48A or 48B of the Road Traffic (Motor Vehicles, Construction and Use) Rules applies; or
- (c) any part of a new or secondhand vehicle is manufactured in Singapore,

the person making the application under paragraph (3) shall, in addition to the documents and fee referred to in paragraph (4), submit —

- (i) a detailed drawing of the vehicle in respect of which the application is made for the approval of the Registrar; and
- (ii) a fee of \$385.20 (inclusive of GST).

(6) The Registrar may waive the fee referred to in paragraph (4)(b), (c) or (d) or (5)(ii).

(7) Where the fee referred to in paragraph (4)(b), (c) or (d) or (5)(ii) is paid by cheque or by means of an electronic fund transfer system and such payment is unsuccessful for any reason, the Registrar may require the payment of an additional fee of \$21.40 (inclusive of GST) for each unsuccessful payment accompanying an application.

(7AA) The fees referred to in paragraphs (4)(b), (c) and (d), (5)(ii) and (7) shall be payable to the Authority.

(7A) The Registrar may refuse to grant, or may revoke, any batch type-approval, type-approval or modified type-approval, of any particular vehicle or batch or model of vehicles if —

- (a) the application contains, or the approval has been procured by the provision to the Registrar of, any particulars, information or document, or by the making of any statement or representation to the Registrar, which is false or misleading in any way;
- (b) the actual fuel consumption or vehicular emissions of the motor vehicle do not conform to the fuel consumption or vehicular emissions of the motor vehicle as stated in the documents submitted to the Registrar under paragraph (4)(aa);

[S 777/2017 wef 01/01/2018]

- (c) there has been a modification to the motor vehicle which has affected the fuel economy or vehicular emissions performance of the vehicle model as stated in the information or documents submitted to the Registrar;

[S 777/2017 wef 01/01/2018]

- (d) the Registrar is satisfied that the authorised dealer, manufacturer or importer of the motor vehicle has contravened any provision under Part IV of the Energy Conservation Act;
- (e) the motor vehicle fails to meet such minimum fuel economy standards, if any, as may be prescribed under Part IV of the Energy Conservation Act in respect of that class, description or type of motor vehicle; or
- (f) the motor vehicle has been modified or retrofitted to operate on a maximum power output that is lower than the maximum power output of the motor vehicle when it was manufactured and as stated in the information or documents submitted by the applicant to the Registrar under paragraph (4).

(7B) The Registrar shall, before revoking any batch type-approval, type-approval or modified type-approval granted, inform the person to whom the approval was granted of his intention to do so and give that person a reasonable opportunity to be heard.

(7C) The Registrar shall, within 14 days after revoking any batch type-approval, type-approval or modified type-approval under paragraph (7A), inform the person to whom the approval was granted in writing of the revocation, the date on which the revocation takes effect and the grounds for the revocation.

(8) In this rule —

“authorised dealer” means a person who is appointed to sell a vehicle in Singapore under a distributorship agreement with the manufacturer of the vehicle;

“batch type-approval” means approval given by the Registrar in respect of a vehicle or a batch of vehicles upon his determination that the vehicle or all the vehicles in the batch are of a type which —

- (a) complies with the applicable relevant Rules; or
- (b) in the case of a vehicle referred to in paragraph (5)(a), complies with all other provisions of the applicable

relevant Rules other than the provisions referred to in that paragraph;

“modified type-approval” means approval given by the Registrar in respect of a model of a vehicle which is modified after being type-approved or a vehicle of which any part is manufactured in Singapore after the model of the vehicle has been type-approved upon his determination that the modified model or the vehicle is of a type which —

- (a) complies with the applicable relevant Rules; or
- (b) in the case of a vehicle referred to in paragraph (5)(a), complies with all other provisions of the applicable relevant Rules other than the provisions referred to in that paragraph;

“new vehicle” means a motor vehicle or trailer which has not been registered under the Act;

“relevant Rules” means the following Rules:

- (a) [*Omitted*]
- (b) rules 18, 19, 20, 21, 42, 43(2), 44(2), 45, 45A, 45B and 45C of these Rules;
- (c) the Road Traffic (Motor Vehicles, Construction and Use) Rules (R 9);
- (d) the Road Traffic (Motor Vehicles, Lighting) Rules (R 10);
- (e) rules 15, 16, 19 and 67 of the Road Traffic (Public Service Vehicles) Rules (R 14);
- (f) the Road Traffic (Motor Vehicles, Seat Belts) Rules (R 15);
- (g) the Road Traffic (Motor Vehicles, Rear and Side Markings) Rules (R 18);
- (h) the Road Traffic (Motor Vehicles, Speed Warning Device) Rules (R 19);

- (i) the Road Traffic (Motor Vehicles, Speed Limiters) Rules (R 39);

“type-approval” means approval given by the Registrar in respect of a model of a vehicle upon his determination that the model of the vehicle is of a type which —

- (a) complies with the applicable relevant Rules; or
(b) in the case of a vehicle referred to in paragraph (5)(a), complies with all other provisions of the applicable relevant Rules other than the provisions referred to in that paragraph.

Vehicle approval code

3E.—(1) Upon granting any batch type-approval, type-approval or modified type-approval under rule 3D, the Registrar shall issue a vehicle approval code in respect of the approved new vehicle, batch of new vehicles or model of new vehicle, as the case may be, to the person applying for such approval under rule 3D.

(2) The vehicle approval code issued under paragraph (1) shall be used for the purpose of registering the new vehicle, batch of new vehicles or model of new vehicle under the Act.

(3) A person who has been issued with a vehicle approval code may apply to transfer the code to any person at any time in such manner as may be specified by the Registrar.

(4) The fee payable to the Authority on the transfer of a vehicle approval code is \$32.10 (inclusive of GST).

(5) The Registrar may waive the fee referred to in paragraph (4).

(6) In this rule, “vehicle approval code” means an alphanumeric code issued by the Registrar upon the approval of the application under rule 3D.

Registration of replacement vehicle

3F.—(1) The Registrar may, upon an application under rule 3 and payment of a processing fee of \$32.10 (inclusive of GST), register a replacement vehicle in substitution of the original vehicle if the

certificate of entitlement of the original vehicle has been transferred to the replacement vehicle under rule 19A of the Road Traffic (Motor Vehicles, Quota System) Rules (R 31).

[S 696/2017 wef 20/12/2017]

(2) Upon the registration of the replacement vehicle —

- (a) the replacement vehicle shall be deemed to have been registered on the date of registration of the original vehicle for the purposes of the Act;
- (b) the registration of the original vehicle shall be cancelled under section 27(d) of the Act;
- (c) the licence issued in respect of the original vehicle under Part VI may be transferred to the replacement vehicle under rule 41A; and
- (d) the index mark and registration number of the original vehicle shall be re-assigned to the replacement vehicle.

(3) No fee shall be payable under rule 6 (registration fee) on the registration of a replacement vehicle.

(4) The amount of the rebate calculated in accordance with paragraph (5) shall be set off against the additional registration fee stipulated in Part II of the First Schedule to be payable in respect of the replacement vehicle under rule 7(1)(a) or (7).

(5) The amount of the rebate referred to in paragraph (4) shall be the sum of —

- (a) the additional registration fee paid in respect of the registration of the original vehicle; and
- (b) any residual value allowed under rule 20 of the Road Traffic (Motor Vehicles, Quota System) Rules or rebate granted by the Registrar under rule 8(4), which was set off against the additional registration fee payable in respect of the registration of the original vehicle.

(6) Except for the rebate provided under paragraph (5)(b), no other residual value allowed under rule 20 of the Road Traffic (Motor Vehicles, Quota System) Rules or rebate granted by the Registrar

under rule 8(4) shall be set off against the additional registration fee in respect of the registration of the replacement vehicle.

(7) For the avoidance of doubt, the rebate referred to in paragraph (4) shall apply in addition to any other rebates granted by the Registrar under these Rules which may be set off against the additional registration fee in respect of the registration of the replacement vehicle.

(8) Where the sum of all the rebates which may be set off against the additional registration fee in respect of the registration of the replacement vehicle exceeds the amount of that additional registration fee, the excess amount of the rebate shall be paid to the last registered owner of the original vehicle.

(9) If the replacement vehicle is a secondhand vehicle, a rebate equal to the sum specified in rule 7(1A) (secondhand vehicle surcharge) and paid in respect of the original vehicle (if any) shall be set off against the sum payable under rule 7(1A) in respect of the replacement vehicle.

(10) Upon the transfer of a licence issued in respect of the original vehicle to the replacement vehicle under paragraph (2)(c) —

- (a) a rebate equal to the refund that would be payable by the Registrar under rule 65 if the licence were surrendered on the actual registration date shall be set off against the licence fee payable under Part VI in respect of the replacement vehicle for the unexpired period of the licence so transferred; and
- (b) no such licence fee shall be payable for the replacement vehicle in respect of the period between the deemed registration date and the eve of the actual registration date (both dates inclusive).

(11) Where the amount of any rebate under paragraph (9) or (10), as the case may be, exceeds the amount against which it may be set off, the excess amount of the rebate shall be paid to the last registered owner of the original vehicle.

(12) Notwithstanding rules 33E(6) and 33G(3), if on the actual registration date both the original vehicle and the replacement vehicle

are new scheme off-peak cars within the meaning of rule 33E or 33G, the rebate for the eligibility period or rebate period under rule 33E(4) or 33G(1), as the case may be, shall be payable at the end of that period —

- (a) for the original vehicle on a pro-rata basis (discounting the period running from the actual registration date); and
- (b) for the replacement vehicle on a pro-rata basis (discounting any period before the actual registration date).

(13) Except as provided in this rule, no fee or part thereof which has been paid under rule 6, 7 or 36 for the original vehicle shall be refunded upon the cancellation of the registration of the original vehicle under paragraph (2)(b).

(14) For the avoidance of doubt, this rule shall not allow any replacement vehicle to be registered under a different registration scheme from that of the original vehicle.

Illustration:

Where the original vehicle was an off-peak car, a PU-registered vehicle or an RU-registered vehicle, the replacement vehicle may only be registered under this rule as an off-peak car, a PU-registered vehicle or an RU-registered vehicle respectively.

(15) In this rule —

“actual registration date”, in relation to a replacement vehicle, means the date on which the replacement vehicle is registered pursuant to paragraph (1);

“deemed registration date”, in relation to a replacement vehicle, means the date on which the replacement vehicle is deemed to have been registered pursuant to paragraph (2)(a).

Vehicle to be produced for inspection

4. The Registrar may, before registering any motor vehicle under these Rules, require the motor vehicle to be produced —

- (a) for his inspection; or

- (b) for an inspection by any examiner authorised by the Registrar under the Road Traffic (Motor Vehicles, Test) Rules (R 21).

Vehicle testing for vehicles which cease to be tax exempt

4A. Where a motor vehicle which is registered on or after 1st January 2013 —

- (a) ceases to be exempt from the payment of any tax payable under section 11 of the Act; and
- (b) does not have recorded in the register of vehicles maintained by the Registrar under rule 12 —
- (i) for a vehicle registered before 1 January 2018, its carbon dioxide emission value; and
- (ii) for a vehicle registered on or after 1 January 2018, its vehicular emission values,

[S 777/2017 wef 01/01/2018]

the Registrar may, before re-registering the motor vehicle under these Rules, require the motor vehicle to be produced for an inspection and testing by any examiner authorised by the Registrar under the Road Traffic (Motor Vehicles, Test) Rules (R 21).

Vehicles which are more than 3 years

5.—(1) Subject to paragraph (2), no vehicle which is more than 3 years old on or after 1st September 1992 shall be registered under the Act.

(2) Paragraph (1) shall not apply to any vehicle —

- (a) which has been registered as a normal vintage vehicle, restricted vintage vehicle or revised use vintage vehicle;
- (b) which is registered as a PU-registered vehicle;
- (c) which is registered or re-registered as a classic vehicle;
- (d) where it is registered in the name of any of the following persons, which is not more than 7 years old:
- (i) a diplomatic agent;

- (ii) a consular officer;
- (iii) the designated spouse or only lawful spouse of a diplomatic agent or consular officer;
- (iv) a member of the administrative and technical staff of a diplomatic mission or consular post;
- (v) a representative, an officer or an employee of such international organisation as may be approved by an authorised officer of the Ministry of Foreign Affairs;
- (vi) a member of a visiting military force who is approved by an authorised officer of the Ministry of Defence and who complies with such conditions for approval as the authorised officer may impose;
- (e) which has been approved by the Registrar as a mobile engineering plant or motor tractor;
- (f) which is registered as a trailer;
- (g) which is registered as a mobile crane;
- (h) which is registered as a recovery vehicle; or
- (i) which was licensed to be kept or used on a road under section 28A of the Act.

(3) In this rule —

“consular officer” means a person entrusted in that capacity with the exercise of consular functions, and includes the head of a consular post;

“designated spouse”, in relation to a diplomatic agent or consular officer with more than one lawful spouse, means the lawful spouse of the diplomatic agent or consular officer whom the Ministry of Foreign Affairs recognises for the purposes of paragraph (2);

“diplomatic agent” means —

- (a) the head of a diplomatic mission; or
- (b) a member of the staff of a diplomatic mission having diplomatic rank;

“member of the administrative and technical staff”, in relation to a diplomatic mission or consular post, means a member of the staff of the diplomatic mission or consular post who is employed in the administrative or technical service of the diplomatic mission or consular post.

Fee payable on registration

6.—(1) The fee payable on the registration of a motor vehicle shall be in accordance with the scale of fees specified in Part I of the First Schedule.

(2) This rule shall not apply to any vehicle which is registered as a PU-registered vehicle on or before 1st February 2001.

(3) The Registrar may, in his discretion, waive in whole or in part the fee payable under paragraph (1).

Additional registration fee

7.—(1) In addition to the fee payable under rule 6 —

- (a) a fee in accordance with the scale specified in Part II of the First Schedule and, where applicable, paragraph (1A) shall be payable on the first registration of a motor vehicle in Singapore whether new or secondhand; and
- (b) a fee in accordance with the scale specified in Part IIA of the First Schedule shall be payable on the registration of a de-registered vehicle in Singapore as a classic vehicle, normal vintage vehicle or revised use vintage vehicle.

(1A) Where a secondhand vehicle (other than a classic vehicle, normal vintage vehicle, restricted vintage vehicle or revised use vintage vehicle) is to be first registered in Singapore using a certificate of entitlement issued on or after 28th February 2004 as a business service passenger vehicle, private hire car, private motor car, off-peak car or station wagon (passengers only), the sum of \$10,000 shall be added to the fee payable under paragraph (1)(a).

(2) No fee shall be payable under this rule in respect of a motor vehicle which is proved to the satisfaction of the Registrar to be for

use in industry or agriculture and not intended for use on a public road.

(3) For the purposes of paragraph (8) and Parts II and IIA of the First Schedule, the value of a motor vehicle shall be determined by the Registrar after making such enquiries, if any, as he thinks fit and the decision of the Registrar shall be final.

(4) Where a motor vehicle is brought into Singapore by a person who is only on a temporary stay, the Registrar may, on registration of the motor vehicle, waive the immediate payment of the fee specified in paragraph (1)(a) in respect of the motor vehicle if there is produced to him in respect of that motor vehicle a guarantee issued in the name of the Automobile Association of Singapore.

(5) The fee specified in paragraph (1)(a) may be waived altogether if it is proved to the satisfaction of the Registrar that the motor vehicle referred to in paragraph (4) has been —

- (a) seriously damaged as a result of an accident or fire; and
- (b) either destroyed at the expense of the parties concerned or abandoned free of all expenses to the Government before the expiration of that guarantee.

(6) A guarantee, produced to the Registrar under paragraph (4), shall be valid for a period of 12 months from the date of entry into Singapore of the motor vehicle in respect of which it is issued; and no fee shall be payable under this rule if such motor vehicle shall be taken out of Singapore within that period of 12 months.

(7) Where a registered vehicle is used in an altered condition or for a purpose which brings it within or which if it was used solely in that condition or for that purpose, would bring it within, a description of vehicle to which a higher rate of fee for the first registration of a vehicle of that description is applicable under Part II of the First Schedule, a fee at that higher rate shall be chargeable for the re-registration of the vehicle.

(8) Where a fee at a higher rate becomes chargeable under paragraph (7) for the re-registration of a vehicle, the vehicle may be re-registered, on payment of the difference between —

- (a) the amount payable for the first registration of the vehicle in the description of vehicle in which it is presently registered; and
 - (b) the amount payable under these Rules for the first registration of the vehicle at the higher rate in force on the date of the re-registration.
- (9) No refund of any fee or part thereof which has been paid for the first registration of a vehicle shall be made if it is re-registered as a vehicle of a description to which a lower rate of fee for the first registration of a vehicle of that description is applicable under Part II of the First Schedule.
- (10) [*Deleted by S 356/2010*]
- (11) This rule shall not apply to a PU-registered vehicle unless —
- (a) the vehicle was a new vehicle at the time it was registered as a PU-registered vehicle; and
 - (b) it is kept or used in any place in Singapore outside Pulau Ubin.

Rebate on additional registration fee

- 8.—**(1) Subject to this rule, any —
- (a) person who desires to purchase a new vehicle which will be registered as an off-peak car, a private hire car or a private motor car;
 - (b) person who registers a new vehicle as a taxi or a business service passenger vehicle using a certificate of entitlement issued on or after 1st April 1998;
 - (c) person who registers a new vehicle as a replacement taxi on or after 1st September 1998;
 - (d) statutory board, company, firm, society, association or club to which a private motor car has been transferred on or after 1st April 1998 and which registers a new vehicle on or after that date; or

- (e) person who, on or after 1st September 2007, registers in Singapore a secondhand vehicle as a business service passenger vehicle, private hire car, private motor car, off-peak car or station wagon (passengers only), which is not more than 3 years old at the date of its registration,

may apply to the Registrar for a rebate on —

- (i) the fees payable under rules 6 and 7; and
(ii) the quota premium payable under the Road Traffic (Motor Vehicles, Quota System) Rules (R 31) for a certificate of entitlement,

in respect of the new vehicle or secondhand vehicle, as the case may be, at the time of its registration.

(2) Subject to this rule —

- (a) where a taxi (other than a replacement taxi) is registered before 1st September 2003 with a certificate of entitlement issued on or after 1st April 1998, and the owner of the taxi applies to the Authority to use or keep the taxi for 8 years, the owner may apply to the Registrar for a rebate on the additional quota premium payable under rule 24B of the Road Traffic (Motor Vehicles, Quota System) Rules for the extension of the certificate of entitlement; and
(b) where a replacement taxi is registered on or after 1st September 1998 but before 1st September 2003, and the owner of the taxi applies to the Authority to use or keep the taxi for 8 years, the owner may apply to the Registrar for a rebate on the additional levy payable under rule 24B of the Road Traffic (Motor Vehicles, Quota System) Rules for the restoration of the certificate of entitlement.

(3) In granting an application for a rebate under paragraph (1) or (2), the Registrar may impose such conditions as he thinks fit.

(4) The Registrar may, in his discretion, grant a rebate if he is satisfied that the applicant satisfies or undertakes to comply with all the following conditions:

- (a) the applicant is or has been the registered owner of a motor vehicle (referred to in this rule as the old vehicle) which is —
- (i) an off-peak car, a private hire car or a private motor car;
 - (ii) a taxi (other than a replacement taxi) or business service passenger vehicle registered using a certificate of entitlement issued on or after 1st April 1998;
 - (iii) a private motor car transferred to a statutory board, company, firm, society, association or club on or after 1st April 1998;
 - (iv) a replacement taxi registered on or after 1st September 1998; or
 - (v) a secondhand vehicle registered in Singapore on or after 1st September 2007 as a business service passenger vehicle, private hire car, private motor car, off-peak car or station wagon (passengers only), which was not more than 3 years old at the date of its registration;
- (b) [*Deleted by S 467/2007*]
- (c) the old vehicle was or will be de-registered at any time on or after 31st December 1975 and —
- (i) it was or will be destroyed or exported; or
 - (ii) the Registrar is satisfied that the old vehicle has been or will be taken off the roads permanently;
- (d) the old vehicle was not or will not be temporarily unlicensed on or after 31st December 1975;
- (e) the old vehicle shall not, at the time of its de-registration, be more than 10 years old;
- (f) the old vehicle has not, on or after 16th September 1977 but before 1st April 1998, been registered as a business service passenger vehicle other than under any of the

circumstances specified in paragraph (22)(b), (c), (d) and (e);

- (g) in the case of an application under paragraph (1), the vehicle in respect of which that the application is made will be registered in the name of the applicant within 12 months of the date of the de-registration of the old vehicle or within such further period as the Registrar may approve.

(h) [*Deleted by S 467/2007*]

(5) Upon granting a rebate under paragraph (4), the Registrar shall issue to the applicant a notice setting out the amount of the rebate which has been granted.

(6) The Registrar may, in his discretion, upon application and the payment of a fee of \$15 and subject to such conditions as he may impose, allow the benefit of a rebate granted under paragraph (4) to be —

- (a) transferred to such person as the registered owner of the old vehicle may nominate; and
- (b) used or further transferred by the person nominated as if he were or had been the registered owner of the old vehicle.

[S 696/2017 wef 20/12/2017]

(7) The amount of the rebate which may be granted under paragraph (4) shall be —

- (a) as specified in Part VI of the First Schedule where the old vehicle has been registered prior to 1st November 1990;
- (b) as calculated in accordance with Part VII of the First Schedule where the old vehicle has been registered on or after 1st November 1990 (not being a vehicle referred to in sub-paragraph (e)), except that where the old vehicle is a vehicle for which a rebate was granted under rule 9 when it was registered and no conversion premium under rule 33(6) has been paid afterwards, the rebate calculated under this sub-paragraph shall not exceed the fee paid under rule 7 when the said vehicle was registered;

- (c) as calculated in accordance with Part VIIA of the First Schedule (which is a sum expressed as a percentage of the relevant additional registration fee) where the old vehicle —
- (i) is a replacement taxi registered on or after 4th May 2002;
 - (ii) is a vehicle (other than a replacement taxi or a secondhand vehicle) registered using a certificate of entitlement issued on or after 4th May 2002; or
 - (iii) is a secondhand vehicle registered on or after 1st September 2007;
- (d) as calculated in accordance with —
- (i) Part VIIA of the First Schedule (which is a sum expressed as a percentage of the relevant additional registration fee) where the old vehicle is a vehicle other than a taxi and has been registered before 1st June 2004 using a certificate of entitlement issued on or after 4th May 2002;
 - (ii) Part IX of the First Schedule (which is a sum expressed as a percentage of the relevant additional registration fee) where the old vehicle is a taxi (other than a replacement taxi) registered before 1st June 2004 using a certificate of entitlement issued on or after 4th May 2002; or
 - (iii) Part IX of the First Schedule (which is a sum expressed as a percentage of the relevant additional registration fee) where the old vehicle is a replacement taxi registered between 4th May 2002 and 31st May 2004 (both dates inclusive),
and the old vehicle was granted a rebate under rule 9A or 9B when it was registered;
- (e) as calculated in accordance with —
- (i) Part VIIA of the First Schedule (which is a sum expressed as a percentage of the relevant additional

registration fee) where the old vehicle is a vehicle other than a taxi and has been registered on or after 1st June 2004 using a certificate of entitlement issued on or after 4th May 2002;

(ii) Part IX of the First Schedule (which is a sum expressed as a percentage of the relevant additional registration fee) where the old vehicle is a taxi (other than a replacement taxi) registered on or after 1st June 2004 using a certificate of entitlement issued on or after 4th May 2002; or

(iii) Part IX of the First Schedule (which is a sum expressed as a percentage of the relevant additional registration fee) where the old vehicle is a replacement taxi registered on or after 1st June 2004,

and the old vehicle was granted a rebate under rule 9A, 9B, 9C or 10 when it was registered;

[S 263/2021 wef 01/01/2018]

(f) as calculated in accordance with Part VIII of the First Schedule where the old vehicle is a taxi which has been registered on or after 1st October 2001 and which was granted a rebate under rule 9B when it was registered; or

[S 263/2021 wef 01/01/2013]

(g) as calculated in accordance with Part X of the First Schedule (which is a sum expressed as a percentage of the relevant additional registration fee) where the old vehicle has been first registered as an off-peak car using a certificate of entitlement issued on or after 4th May 2002 and for which —

(i) a rebate was granted under rule 9 (whether or not a rebate had also been granted under rule 9A, 9B, 9C or 10); or

[S 263/2021 wef 01/01/2018]

(ii) a conversion premium under rule 33(6) has been paid afterwards to re-register the off-peak car as a private motor car.

(8) For the purposes of paragraph (7)(c), (d) and (e), the relevant additional registration fee shall be determined in accordance with the following formula:

$$A - B + C$$

where A is the additional registration fee stipulated in Part II of the First Schedule to be payable in respect of the old vehicle under rule 7(1)(a) or (7);

B is the rebate granted by the Registrar under rule 9A, 9B, 9C or 10 in respect of the old vehicle (applicable only if the old vehicle has been registered on or after 1st June 2004); and

C is the conversion premium payable to the Registrar under rule 9B(9)(b) in respect of any application made to him under rule 9B(8) (applicable only if the old vehicle has been registered on or after 1st June 2004).

[S 263/2021 wef 01/01/2018]

(8A) For the purposes of paragraph (7)(g), the relevant additional registration fee shall be determined in accordance with the following formula:

$$A - (17,000 - B) - C + D + E$$

where A is the additional registration fee stipulated in Part II of the First Schedule to be payable in respect of the old vehicle under rule 7(1)(a);

B is the quota premium (excluding any applicable rebates) payable under rule 14(1) or (1A) of the Road Traffic (Motor Vehicles, Quota System) Rules in respect of the old vehicle;

C is the rebate granted by the Registrar under rule 9A, 9B, 9C or 10 in respect of the old vehicle (applicable only if the old vehicle has been registered on or after 1st June 2004);

D is the conversion premium payable to the Registrar under rule 33(6) to re-register an off-peak car as a private motor car (if applicable); and

E is the conversion premium payable to the Registrar under rule 9B(9)(b) in respect of any application made to him under rule 9B(8) (applicable only if the old vehicle has been registered on or after 1st June 2004),

and the value of $(17,000 - B)$ is 0 where B is more than 17,000.

[S 263/2021 wef 01/01/2018]

(9) Subject to paragraphs (10) and (11), where the amount of the rebate granted under paragraph (4) in respect of —

(a) an application under paragraph (1) exceeds the fees payable under rules 6 and 7 and the quota premium payable under the Road Traffic (Motor Vehicles, Quota System) Rules for a certificate of entitlement, in respect of the vehicle to be registered; or

(b) an application under paragraph (2) exceeds —

(i) the additional quota premium payable under rule 24B of the Road Traffic (Motor Vehicles, Quota System) Rules for the extension of the certificate of entitlement; or

(ii) the additional levy payable under rule 24B of the Road Traffic (Motor Vehicles, Quota System) Rules for the restoration of the certificate of entitlement,

as the case may be,

the excess amount of the rebate shall be forfeited.

(10) A person who holds the benefit of any rebate granted under paragraph (4) may apply to the Registrar for the whole amount of the rebate to be divided into such smaller portions as the applicant may require and —

(a) to use each such portion for —

(i) the registration of a separate vehicle; or

(ii) the extension or restoration of a separate certificate of entitlement under rule 24B of the Road Traffic (Motor Vehicles, Quota System) Rules; or

(b) to transfer any such portion to any other person under paragraph (6).

(11) A person who holds the benefits of the rebates which have been granted under paragraph (4) in respect of 2 or more old vehicles may apply to the Registrar for the benefits of such rebates to be used collectively for —

- (a) the registration of one or more vehicles; or
- (b) the extension or restoration of one or more certificates of entitlement under rule 24B of the Road Traffic (Motor Vehicles, Quota System) Rules.

(12) The Registrar may grant an application under paragraph (10) or (11) subject to such conditions as he thinks fit and shall, upon granting an application under paragraph (10), issue to the applicant a notice in respect of each portion into which the amount of the rebate has been divided.

(13) The notices issued under paragraph (12) shall replace the notice referred to in paragraph (5).

(14) A fee of \$16.05 (inclusive of GST) shall be payable in respect of each portion into which the amount of the rebate is to be divided under paragraph (10).

[S 696/2017 wef 20/12/2017]

(15) Paragraph (4)(c)(ii), (e) and (g) shall not apply to an applicant —

- (a) who is the registered owner of an old vehicle which has been lost on or after 1st January 1976 but before 1st April 1994 and who has made his application not less than 3 months after 1st April 1994;
- (b) who is the registered owner of an old vehicle which has been insured under a policy of insurance effected before 1st April 1994 and which has been lost on or after 1st April 1994 for a period of not less than 3 months at the time the application is made; or

- (c) who is the registered owner of an old vehicle where —
- (i) the vehicle has been insured under a policy of insurance effected on or after 1st April 1994;
 - (ii) the vehicle has been reported to the police, on or after that date, to be lost through theft; and
 - (iii) at the time of the application, a period of more than 3 months has lapsed since the date of such report,
- if —
- (i) in the case only of an old vehicle —
 - (A) which has been lost before 1st April 1994, the old vehicle has not been insured under a policy of insurance which covers theft; or
 - (B) which has been insured under a policy of insurance effected before 1st April 1994 and which has been lost after 1st April 1994, the policy of insurance does not cover theft;
 - (ii) in the case of an old vehicle —
 - (A) which is not a taxi, it was not more than 10 years old at the time it was reported lost; or
 - (B) which is a taxi, it was not more than 8 years old at the time it was reported lost;
 - (iii) the vehicle in respect of which the application is made will be registered in the name of the applicant within 12 months of the Registrar's approval under paragraph (4) or within such further period as the Registrar may approve;
 - (iv) the applicant undertakes to abandon free of all expenses the old vehicle to the Government, or scrap or export it, or take it permanently off the roads in a manner approved by the Registrar, within 6 months of its recovery, if it is subsequently recovered; and
 - (v) the applicant undertakes to pay to the Government a sum equal to the amount of the rebate granted under this rule for the registration of the vehicle in respect of which the

application is made if he fails to comply with sub-paragraph (iv).

(15A) Paragraph (4)(c)(ii), (e) and (g) shall not apply to an applicant who is the registered owner of an old vehicle where —

- (a) the old vehicle has been reported to the police, on or after 1st January 2005, to be lost on or after that date through criminal breach of trust; and
- (b) at the time of the application, a period of more than one year has lapsed since the date of such report,

if —

- (i) in the case of an old vehicle —
 - (A) which is not a taxi, it was not more than 10 years old at the time it was reported lost; or
 - (B) which is a taxi, it was not more than 8 years old at the time it was reported lost;
- (ii) the vehicle in respect of which the application is made will be registered in the name of the applicant within 12 months of the Registrar's approval under paragraph (4) or within such further period as the Registrar may approve;
- (iii) the applicant undertakes to abandon free of all expenses the old vehicle to the Government, or scrap or export it, or take it permanently off the roads in a manner approved by the Registrar, within 6 months of its recovery, if it is subsequently recovered; and
- (iv) the applicant undertakes to pay to the Government a sum equal to the amount of the rebate granted under this rule for the registration of the vehicle in respect of which the application is made if he fails to comply with sub-paragraph (iii).

(15B) Paragraph (4)(c)(ii), (e) and (g) shall not apply to an applicant who is the registered owner of an old vehicle which is seized, on or after 1st January 2005, by any authority under any written law where —

(a) the vehicle —

- (i) has been scrapped or exported, or taken permanently off the roads in a manner approved by the Registrar, upon its release by the authority within such time as the Registrar may, in any particular case, permit; or
- (ii) has been forfeited to the Government or the authority pursuant to an order of court and the Registrar is satisfied that it will be scrapped or exported, or taken permanently off the roads in a manner approved by the Registrar, after its forfeiture;

(b) in the case of an old vehicle —

- (i) which is not a taxi, it was not more than 10 years old at the time it was seized; or
- (ii) which is a taxi, it was not more than 8 years old at the time it was seized; and

(c) the vehicle in respect of which the application is made will be registered in the name of the applicant within 12 months of the Registrar's approval under paragraph (4) or within such further period as the Registrar may approve.

(16) [*Deleted by S 356/2010*]

(17) [*Deleted by S 125/2006*]

(18) Where a vehicle —

- (a) has been registered under these Rules after 1st January 1976 but before 1st November 1990, and a fee, computed in accordance with the preferential scale set out in Part V of the First Schedule was paid on the registration of the vehicle; or
- (b) has been registered on or after 1st November 1990, and a rebate under this rule has been granted for the registration of the vehicle,

such vehicle may, upon payment of the amount required under paragraph (20) —

- (i) on transfer of ownership of the vehicle, be reclassified as a business service passenger vehicle; or
 - (ii) on transfer of ownership of the vehicle from a firm or company referred to in paragraph (22)(b), (c), (d) or (e) to any other firm or company or any statutory board, society, club or association, remain as a business service passenger vehicle.
- (19) This rule shall not apply to —
- (a) a business service passenger vehicle registered using a certificate of entitlement issued before 1st April 1998; or
 - (b) a private motor car transferred to a statutory board, company, firm, society, club or an association before 1st April 1998.
- (20) Where an additional registration fee would be payable under rule 7 if the vehicle were first registered under these Rules on the date of the transfer, the amount of the payment referred to in paragraph (18) shall be —
- (a) in the case of a vehicle referred to in paragraph (18)(a), the difference between the amount payable under rule 7 and the amount payable in accordance with the preferential scale set out in Part V of the First Schedule at the date of the registration of the vehicle; or
 - (b) in the case of a vehicle referred to in paragraph (18)(b), the amount of the rebate granted under this rule for the registration of the vehicle.
- (21) For the purposes of paragraph (20)(a), the value of the vehicle shall be determined as at the date of its transfer by depreciating the value of the vehicle as determined by the Registrar under rule 7(3) on the date of its first registration under these Rules over 10 years, except that the value of a vehicle which is less than one year old at the date of its transfer shall be the same as that determined by the Registrar under rule 7(3) on the date of its first registration under these Rules.
- (22) Paragraph (18) shall not apply to a transfer of the ownership of a vehicle —

- (a) in respect of which payment has been made under that paragraph on a previous transfer of the vehicle;
- (b) to a firm or a company which repossesses such vehicle under the Hire-Purchase Act (Cap. 125) for the purpose of selling the vehicle or letting it to a hirer under that Act;
- (c) to a firm or a company which deals in secondhand motor vehicles and which buys the vehicle for the purpose of reselling it;
- (d) to an insurer registered under the Insurance Act (Cap. 142) which takes over the vehicle from an insured under a policy of insurance; or
- (e) to such other firm or company as the Minister may, from time to time, determine.

Circumstances when rebate payable in cash

8A.—(1) Without prejudice to anything in rule 8, a person —

- (a) to whom a rebate is granted on or after 1st September 2008 on —
 - (i) the fees payable under rules 6 and 7 and the quota premium payable under the Road Traffic (Motor Vehicles, Quota System) Rules (R 31) for a certificate of entitlement under rule 8(1); or
 - (ii) the additional quota premium payable under rule 24B of the Road Traffic (Motor Vehicles, Quota System) Rules for the extension or restoration of a certificate of entitlement relating to that motor vehicle under rule 8(2); or
- (b) who, immediately before 1st September 2008, holds the benefit of a rebate granted under rule 8(4) and has not registered a new or secondhand motor vehicle in respect of which that rebate was granted,

may, within the grace period, apply to the Registrar to be paid, in lieu of the rebate, a sum of cash equal to the amount of the rebate set out in any notice issued under rule 8(5) or (12) that he holds.

(2) Upon receipt of an application in accordance with paragraph (1), the Registrar may —

- (a) grant the application and, subject to paragraph (3), pay the applicant the sum of cash equal to the amount of rebate which has been granted and set out in a notice under rule 8(5) or (12); or
- (b) refuse the application.

(3) The Registrar may refuse to make any payment of any sum of cash under paragraph (2)(a) to a holder of the benefit of a rebate granted under rule 8(4) in respect of a motor vehicle if the Registrar is not satisfied that no amount of any tax under section 11(1)(b) of the Act or any fee under section 21 or 30 of the Act is due and payable in respect of that motor vehicle.

(4) In relation to any application under paragraph (1) to be paid a sum of cash equal to the amount set out in a notice under rule 8(5) or (12) as the amount of the rebate which has been granted, “grace period” means a period of 12 months starting on the date of the notice, or such longer period as the Registrar may allow in relation to any particular application.

(5) For the avoidance of doubt, nothing in this rule shall entitle any person to receive or apply to receive any sum of cash —

- (a) in the circumstances described in rule 8(9); or
- (b) in lieu of any rebate granted under rule 9, 9A, 9AA, 9B, 9C or 10.

[S 263/2021 wef 01/01/2018]

Rebate for off-peak car

9.—(1) Subject to rule 8, a person who desires to purchase a vehicle which will be registered as an off-peak car may apply to the Registrar for a rebate on —

- (a) the fee payable under rule 7; and
- (b) the quota premium payable under the Road Traffic (Motor Vehicles, Quota System) Rules (R 31) for a certificate of entitlement,

in respect of the new vehicle at the time of its registration.

(2) In granting an application under paragraph (1), the Registrar may impose such conditions as he thinks fit.

(3) The Registrar may, subject to paragraph (6), grant a rebate of the whole or part of the additional registration fee for an off-peak car registered with a certificate of entitlement issued before 4th May 2002 which shall be determined in accordance with the following formula:

$$T \times \frac{C}{A + B + C}$$

where T is equal to the sum of A, B and C, if the sum of A, B and C does not exceed the appropriate maximum rebate specified in paragraph (5) or, otherwise, the amount of the appropriate maximum rebate specified in that paragraph;

A is the amount of customs duties paid in respect of the motor car under the Customs (Duties) Order (Cap. 70, O 4);

B is the quota premium payable under rule 14(1) of the Road Traffic (Motor Vehicles, Quota System) Rules for the certificate of entitlement of the motor car; and

C is the net additional registration fee.

(4) The Registrar may, in his discretion, grant a rebate, not exceeding \$17,000, of the whole or part of —

(a) the additional registration fee; and

(b) the quota premium payable under the Road Traffic (Motor Vehicles, Quota System) Rules for a certificate of entitlement,

for an off-peak car registered with a certificate of entitlement issued on or after 4th May 2002.

- (5) For the purposes of paragraph (3) —
- (a) the maximum rebate shall be —
 - (i) in the case of an off-peak car in respect of which a category (f) certificate of entitlement has been issued, \$15,000; and
 - (ii) in any other case, \$17,000;
 - (b) the net additional registration fee shall be an amount equal to 70% of the value of the motor car determined by the Registrar under rule 7(3) if the motor car is registered using a certificate of entitlement issued before 1st April 1998; and
 - (c) the net additional registration fee shall be an amount equal to 60% of the value of the motor car determined by the Registrar under rule 7(3) if the motor car is registered using a certificate of entitlement issued on or after 1st April 1998.
- (6) The Registrar may, on or after 1st October 1994, grant to the holder of a category (f) certificate of entitlement the rebate granted under paragraph (3) for an off-peak car in respect of which a certificate of entitlement other than a category (f) certificate of entitlement has been issued if the holder of the certificate pays to the Registrar a sum of an amount equivalent to any positive difference derived by deducting —
- (a) the quota premium paid under the Road Traffic (Motor Vehicles, Quota System) Rules for the category (f) certificate of entitlement; from
 - (b) the quota premium which would have been payable under the Road Traffic (Motor Vehicles, Quota System) Rules for a certificate of entitlement for a motor vehicle of the appropriate cylinder capacity which was issued at the same time as the category (f) certificate of entitlement.

Rebate for electric car, petrol-electric car, new electric taxi and new petrol-electric taxi

9A.—(1) Subject to rule 8, a person who desires to register a new or a secondhand electric car or petrol-electric car, or a new electric taxi or petrol-electric taxi, may apply to the Registrar for a rebate on —

- (a) in the case of a new vehicle first registered before 1st June 2004 — the fees payable under rules 6 and 7, and the quota premium payable under the Road Traffic (Motor Vehicles, Quota System) Rules (R 31) for a certificate of entitlement;
- (b) in the case of a new vehicle first registered on any date between 1st June 2004 and 31st December 2012 (both dates inclusive) — the fee payable under rule 7(1)(a) in respect of the new vehicle at the time of its first registration on any date between 1st June 2004 and 31st December 2012 (both dates inclusive); or
- (c) in the case of a secondhand vehicle first registered in Singapore on any date between 1st July 2010 and 31st December 2012 (both dates inclusive) — the fee payable under rule 7(1)(a), exclusive of any sum added to such fee pursuant to rule 7(1A), in respect of the secondhand vehicle at the time of its first registration in Singapore on any date between 1st July 2010 and 31st December 2012 (both dates inclusive).

(2) In granting an application under paragraph (1), the Registrar may impose such conditions as he thinks fit.

(2A) The Registrar shall not grant an application under paragraph (1) unless he is satisfied —

- (a) that the vehicle was originally constructed by a manufacturer approved by the Registrar to use electricity exclusively, or to use either or both electricity and petrol, as its sources of power; or
- (b) where the vehicle was originally constructed by its manufacturer to use petrol exclusively as its source of power but has been modified or retrofitted to operate on multiple power sources, either separately or

simultaneously, that the vehicle is safe for use on the roads and satisfies such exhaust emission criteria that is acceptable to the Registrar.

(3) Subject to paragraph (4), the amount of the rebate which the Registrar may grant upon an application under paragraph (1) shall be —

- (a) in the case of a new vehicle first registered before 1st January 2006, an amount equal to 20% of the value of the vehicle at the date of its first registration as determined by the Registrar under rule 7(3);
- (b) in the case of a new vehicle first registered on any date between 1st January 2006 and 31st December 2012 (both dates inclusive), an amount equal to 40% of the value of the vehicle at the date of its first registration as determined by the Registrar under rule 7(3); or
- (c) in the case of a secondhand vehicle first registered in Singapore on any date between 1st July 2010 and 31st December 2012 (both dates inclusive), an amount equal to 40% of the value of the vehicle at the date of its first registration in Singapore as determined by the Registrar under rule 7(3).

(4) In the case of a new vehicle first registered before 1st June 2004, where the amount of the rebate allowable under paragraph (3) exceeds the sum of —

- (a) the fees payable under rules 6 and 7; and
- (b) the quota premium payable under the Road Traffic (Motor Vehicles, Quota System) Rules for a certificate of entitlement,

the excess amount of the rebate shall be forfeited.

(5) Where the amount of the rebate allowable under paragraph (3) exceeds the sum of the fees payable under rule 7, the excess amount of the rebate shall be forfeited.

Rebate for electric vehicle and petrol-electric vehicle

9AA.—(1) Any person who desires to register as a new vehicle or a secondhand vehicle, an electric vehicle or a petrol-electric vehicle that is —

- (a) a light goods vehicle;
- (b) a heavy goods vehicle;
- (c) a goods-cum-passengers vehicle;
- (d) a bus; or
- (e) a motor cycle or a scooter,

may apply to the Registrar for a rebate, in respect of the vehicle at the time of its first registration, on the fees payable under rule 7.

(2) In granting an application under paragraph (1), the Registrar may impose such conditions as he thinks fit.

(2A) The Registrar shall not grant an application under paragraph (1) unless he is satisfied —

- (a) that the vehicle was originally constructed by a manufacturer approved by the Registrar to use electricity exclusively, or to use either or both electricity and petrol, as its sources of power; or
- (b) where the vehicle was originally constructed by its manufacturer to use petrol exclusively as its source of power but has been modified or retrofitted to operate on multiple power sources, either separately or simultaneously, that the vehicle is safe for use on the roads and satisfies such emission criteria that is acceptable to the Registrar.

(3) Subject to paragraph (4), the amount of the rebate which the Registrar may grant upon an application under paragraph (1) shall be as follows:

- (a) if the vehicle is —
 - (i) a light goods vehicle;
 - (ii) a heavy goods vehicle;

- (iii) a goods-cum-passengers vehicle; or
- (iv) a bus,

and is first registered on any date between 1st January 2008 and 30 June 2015 (both dates inclusive) — an amount equal to 5% of the value of the vehicle at the date of its first registration as determined by the Registrar under rule 7(3);

[S 678/2014 wef 03/10/2014]

(b) if the vehicle is —

- (i) a secondhand light goods vehicle;
- (ii) a secondhand heavy goods vehicle;
- (iii) a secondhand goods-cum-passengers vehicle; or
- (iv) a secondhand bus,

and is first registered in Singapore on any date between 1st July 2010 and 30 June 2015 (both dates inclusive) — an amount equal to 5% of the value of the vehicle at the date of its first registration as determined by the Registrar under rule 7(3);

[S 678/2014 wef 03/10/2014]

(c) if the vehicle is —

- (i) an electric motor cycle or an electric scooter and is first registered on any date between 13th April 2009 and 30 June 2015 (both dates inclusive); or

[S 678/2014 wef 03/10/2014]

- (ii) a secondhand electric motor cycle or a secondhand electric scooter and is first registered on any date between 1st July 2010 and 30 June 2015 (both dates inclusive),

[S 678/2014 wef 03/10/2014]

an amount equal to 10% of the value of the vehicle at the date of its first registration as determined by the Registrar under rule 7(3).

(4) Where the amount of the rebate allowable under paragraph (3) exceeds the sum of the fees payable under rule 7, the excess amount of the rebate shall be forfeited.

Rebate for environmentally-friendly motor vehicle

9B.—(1) Subject to paragraph (7) and rule 8, any person who desires to register a new vehicle which is an environmentally-friendly motor vehicle, may apply to the Registrar for a rebate on —

- (a) the fees payable under rules 6 and 7, in respect of the new vehicle at the time of its first registration on any date between 1st October 2001 and 31st May 2004 (both dates inclusive); or
- (b) the fee payable under rule 7, in respect of the new vehicle at the time of its first registration on or after 1st June 2004.

(2) The Registrar may grant an application made under paragraph (1) if he is satisfied that the new vehicle in respect of which the application is made is a vehicle that comes within any of the descriptions in paragraph (5)(a) to (j).

(3) Every grant of rebate under this rule in respect of a new vehicle shall be subject to —

- (a) the condition that the CNG system or the engine recorded in the register of vehicles shall not be modified, replaced or removed from the vehicle without the approval of the Registrar; and
- (b) such other conditions as the Registrar may impose.

(4) If a person who has been granted a rebate under this rule in respect of a new vehicle fails to comply with any condition subject to which a rebate has been granted —

- (a) that person shall be guilty of an offence; and
- (b) the Registrar may, by notice in writing —
 - (i) prohibit that person from keeping or using that vehicle on the road as from the date specified in the notice; and

- (ii) require that person, within such time as may be specified in the notice, to produce proof to the satisfaction of the Registrar that the vehicle has been destroyed, exported, scrapped or permanently removed from all roads in Singapore.

(5) The rebate which the Registrar may grant upon an application made under paragraph (1) shall, subject to paragraph (6), be —

- (a) if the vehicle, being a private motor car, private hire motor car, station wagon (passengers only) or business service passenger vehicle (excluding a taxi), is a CNG vehicle or petrol-CNG vehicle, an amount equal to —
 - (i) 20% of the value of the vehicle if registered before 1st January 2006; or
 - (ii) 40% of the value of the vehicle if registered between 1st January 2006 and 31st December 2012 (both dates inclusive);
- (b) if the vehicle is a taxi which is a CNG vehicle or petrol-CNG vehicle and is registered on or after 1st June 2004 but before 1st January 2006, an amount equal to 100% of the value of the vehicle;
- (c) if the vehicle is a taxi which is a CNG vehicle or petrol-CNG vehicle and is registered on or after 1st January 2006 but before 1st October 2006, an amount equal to 80% of the value of the vehicle;
- (d) if the vehicle is a taxi which is a CNG vehicle or petrol-CNG vehicle and is registered on or after 1st October 2006 but before 1st January 2013, an amount equal to 40% of the value of the vehicle;
- (e) if the vehicle is a taxi which uses diesel exclusively as its source of power, complies with the Euro IV standard and is registered on or after 1st June 2004 but before 1st January 2006, an amount equal to 100% of the value of the vehicle;
- (f) if the vehicle is a taxi which uses diesel exclusively as its source of power, complies with the Euro IV standard and is

registered on or after 1st January 2006 but before 1st October 2006, an amount equal to 80% of the value of the vehicle;

- (g) if the vehicle is a taxi which uses diesel exclusively as its source of power, complies with the Euro IV standard and is registered on or after 1st October 2006 but before 1st January 2008, an amount equal to 40% of the value of the vehicle;
- (h) if the vehicle, being a bus or a light goods vehicle or heavy goods vehicle (excluding a goods-cum-passengers vehicle), is a CNG vehicle or petrol-CNG vehicle and is registered on or after 1st June 2004 but before 1st January 2006, an amount equal to 5% of the value of the vehicle;
- (i) if the vehicle, being a bus or a light goods vehicle or heavy goods vehicle (including a goods-cum-passengers vehicle), is a CNG vehicle or petrol-CNG vehicle and is registered on or after 1st January 2006 but before 1 July 2015, an amount equal to 5% of the value of the vehicle; or

[S 678/2014 wef 03/10/2014]

- (j) if the vehicle, being a bus or a light goods vehicle or heavy goods vehicle (excluding a goods-cum-passengers vehicle), uses diesel exclusively as its source of power, complies with the Euro IV standard and is registered on or after 1st June 2004 but before 1st January 2008, an amount equal to 5% of the value of the new vehicle,

as determined by the Registrar under rule 7(3) at the date of its first registration.

(6) Subject to paragraph (8), where the amount of the rebate allowable under paragraph (5) exceeds the sum of —

- (a) the fees payable under rules 6 and 7 in respect of the new vehicle at the time of its first registration before 1st June 2004; or
- (b) the fee payable under rule 7 in respect of the new vehicle at the time of its first registration on or after 1st June 2004,

the excess amount of the rebate shall be forfeited.

(7) This rule does not apply to any new vehicle which is an electric car, an electric vehicle, a petrol-electric car or a petrol-electric vehicle.

(8) The registered owner of a vehicle may apply to the Registrar to have the CNG system recorded in the register of vehicles removed from that vehicle.

(9) Every application under paragraph (8) shall be accompanied by —

- (a) such information as the Registrar may require to ensure that the CNG system is properly removed from the vehicle and that the vehicle will continue to be safe for use on the roads after such removal has been carried out;
- (b) payment to the Registrar of a conversion premium specified in paragraph (10) if a rebate under this rule had previously been given; and
- (c) a processing fee of \$32.10 (inclusive of GST).

[S 696/2017 wef 20/12/2017]

(10) For the purposes of paragraph (9), the conversion premium shall be determined in accordance with the following formula:

$$\frac{A \times B}{C}$$

where A is the rebate granted by the Registrar under rule 9B in respect of the vehicle;

B is —

- (a) in the case of a vehicle which is not a taxi, 120 months less the period (in months) for which the vehicle has been registered as a petrol-CNG vehicle or CNG vehicle at the time of its conversion to a petrol vehicle or diesel vehicle under this rule; or
- (b) in the case of a taxi, 96 months less the period (in months) for which the taxi has been registered as a petrol-CNG taxi or CNG taxi at the time of its conversion to a petrol taxi or diesel taxi under this rule; and

C is —

- (a) in the case of a vehicle which is not a taxi, 120 months; or
- (b) in the case of a taxi, 96 months.

(11) The Minister may, in his discretion, waive in whole or in part any conversion premium payable under paragraph (9)(b) if he is satisfied that the removal of the CNG system was necessitated by a defect which may compromise or had compromised the safe use of the vehicle.

(12) The Registrar may, in his discretion, waive in whole or in part the processing fee referred to in paragraph (9)(c).

(13) The Registrar may, when approving an application in paragraph (8), subject the approval to such conditions as he may think fit to impose.

Carbon emissions rebate for new or secondhand car or taxi registered on or after 1st January 2013

9C.—(1) Subject to rule 8 —

- (a) where a new or a secondhand vehicle is to be first registered in Singapore on or after 1 January 2013 but before 1 January 2018 as a motor car (other than a taxi) and has a carbon emission level below the minimum limit of the neutral carbon emission band for the vehicle; or

[S 359/2015 wef 01/07/2015]

[S 777/2017 wef 01/01/2018]

- (b) where a new vehicle is to be registered in Singapore on or after 1 January 2013 but before 1 January 2018 as a taxi and has a carbon emission level below the minimum limit of the neutral carbon emission band for the vehicle,

[S 359/2015 wef 01/07/2015]

[S 777/2017 wef 01/01/2018]

the registered owner of the vehicle may apply to the Registrar for a rebate on the fee payable under rule 7(1)(a) in respect of the vehicle to be first registered.

(2) Subject to paragraphs (6) and (7), the amount of the rebate which the Registrar may grant upon an application under paragraph (1) shall be as specified in Part IIB or IIC of the First Schedule, as the case may be.

(3) In the case of a secondhand vehicle, any rebate granted under paragraph (1) shall not be used to offset the sum of \$10,000 payable under rule 7(1A) at the time of its first registration in Singapore.

(4) In granting an application under paragraph (1), the Registrar may impose such conditions as he thinks fit.

(5) The Registrar shall not grant an application under paragraph (1) unless he is satisfied —

(a) that the vehicle was originally constructed by a manufacturer approved by the Registrar; or

(b) where the vehicle was originally constructed by its manufacturer but has been modified or retrofitted to operate on multiple power sources, either separately or simultaneously, that the vehicle is safe for use on the roads and satisfies such exhaust emission criteria that is acceptable to the Registrar.

(6) Where the amount of fee payable under rule 7(1)(a) is less than \$5,000 after the rebate under paragraph (2) is granted, the minimum amount of fee payable under rule 7(1)(a) shall be \$5,000.

(7) Where the amount of rebate allowable under paragraph (2) exceeds the fee payable under rule 7, the excess amount of the rebate shall be forfeited.

(8) No rebate under this rule shall be given to a new or a secondhand vehicle which uses diesel as one of its sources of power and does not comply with the Euro V standard or the JPN 2009 standard.

(9) In this rule, the neutral carbon emission band —

(a) for a new or second hand vehicle first registered in Singapore as a motor car (other than a taxi) during the period from 1 January 2013 to 30 June 2015 (both dates inclusive), is the range of carbon emissions starting with

161 carbon dioxide grams per kilometre and ending with 210 carbon dioxide grams per kilometre;

- (b) for a new or second hand vehicle first registered in Singapore as a motor car (other than a taxi) during the period from 1 July 2015 to 31 December 2017 (both dates inclusive), is the range of carbon emissions starting with 136 carbon dioxide grams per kilometre and ending with 185 carbon dioxide grams per kilometre;

[S 335/2017 wef 30/06/2017]

- (c) for a new vehicle first registered in Singapore as a taxi during the period from 1 January 2013 to 30 June 2015 (both dates inclusive), is the range of carbon emissions starting with 161 carbon dioxide grams per kilometre and ending with 210 carbon dioxide grams per kilometre; and

- (d) for a new vehicle first registered in Singapore as a taxi during the period from 1 July 2015 to 31 December 2017 (both dates inclusive), is the range of carbon emissions starting with 136 carbon dioxide grams per kilometre and ending with 185 carbon dioxide grams per kilometre.

[S 359/2015 wef 01/07/2015]

[S 335/2017 wef 30/06/2017]

Vehicular emissions rebate for new or secondhand car or taxi registered on or after 1 January 2018

10.—(1) Subject to rule 8 —

(a) where —

(i) a new or secondhand vehicle is to be first registered in Singapore on or after 1 January 2018 as a motor car (other than a taxi); or

(ii) a new vehicle is to be registered in Singapore on or after 1 January 2018 as a taxi; and

- (b) each prescribed vehicular emission from the vehicle has a vehicular emission level that is in Band A1 or Band A2 for that emission,

then the registered owner of the vehicle may apply to the Registrar for a rebate on the fee payable under rule 7(1)(a) in respect of the vehicle.

(2) Subject to paragraphs (6) and (7), the amount of the rebate which the Registrar may grant upon an application under paragraph (1) is as follows:

(a) where the emission level of any of the prescribed vehicular emissions from the vehicle falls within Band A2 for that emission —

(i) for a vehicle first registered as a motor car other than a taxi, \$10,000; and

(ii) for a vehicle first registered as a taxi, \$15,000;

(b) where none of the emission levels of any of the prescribed vehicular emissions from the vehicle fall within Band A2 for that emission —

(i) for a vehicle first registered as a motor car other than a taxi, \$20,000; and

(ii) for a vehicle first registered as a taxi, \$30,000.

(3) In the case of a secondhand vehicle, any rebate granted under paragraph (2) must not be used to offset the sum of \$10,000 payable under rule 7(1A) at the time of its first registration in Singapore.

(4) In granting an application under paragraph (1), the Registrar may impose such conditions as he thinks fit.

(5) The Registrar must not grant an application under paragraph (1) unless he is satisfied —

(a) that the vehicle was originally constructed by a manufacturer approved by the Registrar; or

(b) where the vehicle was originally constructed by its manufacturer but has been modified or retrofitted to operate on multiple power sources, either separately or simultaneously, that the vehicle is safe for use on the roads and satisfies such exhaust emission criteria that is acceptable to the Registrar.

(6) Where the amount of fee payable under rule 7(1)(a) is less than \$5,000 after the rebate under paragraph (2) is granted, the minimum amount of fee payable under rule 7(1)(a) is \$5,000.

(7) Where the amount of rebate allowable under paragraph (2) exceeds the fee payable under rule 7, the excess amount of the rebate is forfeited.

(8) In this rule —

“Band A1”, in relation to any prescribed vehicular emission, means the range of emission levels that is specified under Band A1 for such emission in Part III of the First Schedule;

“Band A2”, in relation to any prescribed vehicular emission, means the range of emission levels that is specified under Band A2 for such emission in Part III of the First Schedule;

“emission level”, in relation to any prescribed vehicular emission, means the quantity of that prescribed vehicular emission expressed in the unit of measurement specified in Part III of the First Schedule for that prescribed vehicular emission;

“prescribed vehicular emission” means any prescribed vehicular emission described as such in Part III of the First Schedule.

[S 777/2017 wef 01/01/2018]

11. *[Deleted by S 125/2006]*

Register of vehicles

12. The Registrar shall maintain a register of vehicles containing such particulars of all vehicles as he may think fit.

Change of registration particulars to be notified

12A.—(1) Subject to paragraph (3), the registered owner of a vehicle shall immediately inform the Registrar in writing of any circumstance or event which affects the accuracy of any entry in the register of vehicles kept by the Registrar under rule 12.

(2) The registered owner of a vehicle shall, whenever required by the Registrar to do so, immediately furnish to the Registrar all such

information as he may require for the purpose of verifying the entries relating to that vehicle in the register of vehicles.

(3) Where the registered owner of a vehicle who has changed his residential address immediately makes a report of the change under section 8 of the National Registration Act (Cap. 201), he shall be deemed to have informed the Registrar of the change of his residential address in compliance with paragraph (1).

Modification of registered vehicles

12B.—(1) Where the registered owner of a vehicle makes or intends to make a minor modification to the vehicle which results or would result in a deviation from the particulars of the vehicle entered in the register, he shall notify the Registrar by furnishing the Registrar with particulars of the modification or proposed modification, together with a fee of \$25.68 (inclusive of GST).

(2) Subject to paragraph (3), where the registered owner of a vehicle intends to make a major modification to the vehicle which would result in a deviation from the particulars of the vehicle entered in the register, he shall, before making the modification, apply to the Registrar for approval of the proposed modification.

(3) The application referred to in paragraph (2) shall be accompanied by a fee of \$64.20 (inclusive of GST).

(4) Where the major modification consists solely of the installation or use of a pre-approved vehicle accessory, the registered owner of the vehicle who makes or intends to make the major modification shall, instead of applying to the Registrar for approval of the proposed modification, notify the Registrar by furnishing the Registrar with particulars of the modification or proposed modification, together with a fee of \$25.68 (inclusive of GST).

(5) The manufacturer or authorised dealer of any vehicle accessory may apply to the Registrar for approval of that vehicle accessory as a pre-approved vehicle accessory to be installed in or used for any particular motor vehicle, model of motor vehicle or batch of motor vehicles.

(6) An application under paragraph (5) shall be accompanied by —

- (a) such information and documents as the Registrar may require in respect of that vehicle accessory; and
- (b) a non-refundable fee of \$214 (inclusive of GST).

(7) Where the fee referred to in paragraph (1), (3), (4) or (6) is paid by cheque or electronic fund transfer and such payment transaction is unsuccessful for any reason, an additional fee of \$21.40 (inclusive of GST) shall be payable for each unsuccessful payment transaction.

(7A) The fees referred to in paragraphs (1), (3), (4), (6) and (7) shall be payable to the Authority.

(8) The Registrar may waive the fee referred to in paragraph (1), (3), (4), (6) or (7).

(9) In this rule —

“exhaust system” has the same meaning as in rule 106 of the Road Traffic (Motor Vehicles, Construction and Use) Rules (R 9);

“major modification” means any modification which —

- (a) involves any modification or alteration of the exhaust system of a vehicle;
- (b) would result in a vehicle of a description set out in the Second Schedule becoming a vehicle of another description set out in that Schedule; or
- (c) may affect the safe operation of the vehicle;

“minor modification” means any modification which —

- (a) does not involve any modification or alteration of the exhaust system of a vehicle;
- (b) would not result in a change in the description of the vehicle as set out in the Second Schedule; and
- (c) would not affect the safe operation of a vehicle;

“pre-approved vehicle accessory” means any vehicle accessory which has been approved by the Registrar pursuant to an application under paragraph (5);

“register” means the register of vehicles maintained by the Registrar under rule 12;

“vehicle accessory” means any aftermarket system, component, part, add-on, equipment, appliance or accessory for the performance enhancement, repair or maintenance of a motor vehicle.

Search fee

13.—(1) The Registrar may, upon an application by any person, provide a copy of or an extract of the entry in the register relating to any vehicle, subject to such conditions as the Registrar may impose and the payment of the fees under this rule.

[S 696/2017 wef 20/12/2017]

(2) The fee payable for a copy of or an extract of the entry in the register relating to any one vehicle shall be \$7.49 (inclusive of GST).

[S 696/2017 wef 20/12/2017]

(3) Where the copy or extract referred to in paragraph (2) is required to be certified as a true copy of the entry by the Registrar, a further fee of \$5.35 (inclusive of GST) shall be payable.

(4) Where any search of the register relating to any one vehicle is necessary, the Registrar may require the payment of a further fee not exceeding \$35.31 (inclusive of GST).

[S 696/2017 wef 20/12/2017]

(5) The fee payable for a copy of or an extract of the entry in the register shall be at the rate of \$2.14 (inclusive of GST) for every 100 words or part thereof and, if the copy or extract is required to be certified as a true copy of the entry, a further fee of \$5.35 (inclusive of GST) shall be payable for the certificate.

(6) The Registrar may, in his discretion, refuse to provide any particulars in relation to an entry in the register relating to any vehicle to any person making an application under paragraph (1).

(7) The Registrar may waive in whole or in part any fee payable under this rule.

(8) Where payment of the applicable fee mentioned in paragraph (2), (3), (4) or (5) is tendered in a form other than cash and the payment is subsequently dishonoured or otherwise not effected, an additional fee for processing the dishonoured payment of \$32.10 (inclusive of GST) is payable.

[S 696/2017 wef 20/12/2017]

PART III

INDEX AND IDENTIFICATION MARKS

Index mark

14.—(1) The index mark indicating that a motor vehicle has been registered in Singapore shall be as set out in the Third Schedule.

(2) The Registrar may, under special circumstances, assign an index mark to a vehicle or type of vehicle not in accordance with the Third Schedule.

(3) The index mark and the registration number shall be suffixed with a letter of the alphabet which will serve as the official reference.

(4) Except where the Registrar otherwise permits, paragraph (3) shall apply to —

(a) every motor vehicle registered on or after 8th February 1972; and

(b) every motor vehicle registered before 8th February 1972 —

(i) on which an index mark and a registration number allotted under rule 16 have been used in accordance with rule 16(8)(b);

(ii) on which an index mark and a registration number assigned under rule 16A(1) have been used; or

(iii) the assignment of an identification mark to which has been approved by the Registrar under rule 22(3) in the circumstances referred to in rule 22(3)(b) or (d).

- (5) The Registrar may, in his discretion —
- (a) decline to assign any index mark set out in the Third Schedule; and
 - (b) assign the index marks for any type of vehicles in a sequence other than that set out in the Third Schedule.

Application for cancellation of assigned index mark

15.—(1) Subject to paragraph (4), a person in whose name a motor vehicle is to be registered or any dealer in motor vehicles who has been duly authorised by such person may, before the registration of the motor vehicle, apply to the Registrar for the cancellation of the index mark which has been assigned to that motor vehicle under rule 14 in order that he may apply for a particular index mark in respect of that motor vehicle under rule 16.

- (2) An application under paragraph (1) shall be —
- (a) made in such form and within such time as may be required by the Registrar; and
 - (b) accompanied by a fee of \$321 (inclusive of GST).

(3) The Registrar may require any person making an application under this rule to submit such other information or comply with such other conditions as the Registrar may specify.

(4) This rule shall apply only in respect of motor vehicles which have not been previously registered under these Rules.

Applications for particular index marks and registration numbers

16.—(1) The Registrar may, from time to time, by public notice or such other means as he may think fit, invite bids for particular index marks and registration numbers for any type or category of vehicle.

- (2) Every application under paragraph (1) shall be —
- (a) made in such form and within such time as may be required by the Registrar;

- (b) accompanied by a deposit of the full proposal amount expressed in the application in such form as may be required by the Registrar;

[S 272/2016 wef 17/06/2016]

- (ba) accompanied by an application fee of \$10.70 (inclusive of GST); and

[S 272/2016 wef 17/06/2016]

- (c) subject to such other terms and conditions as the Registrar may think fit to impose.

(3) No application shall be withdrawn after it has been received by the Registrar.

(4) The Registrar may, in his discretion, allow the particulars of a bid or a bidder to be amended upon payment of a fee of \$32.10 (inclusive of GST).

[S 696/2017 wef 20/12/2017]

(5) The Registrar may, in his discretion, reject any application without assigning any reason.

(6) The Registrar shall not be obliged to allot the index mark and registration number applied for to the applicant offering the highest proposal amount and the Registrar's determination of successful applications shall be final.

(7) The Registrar shall notify every applicant of the outcome of his application.

(8) Subject to paragraph (9), a successful applicant shall, within 12 months of the date of the notification issued by the Registrar under paragraph (7), use the index mark and registration number allotted to him —

- (a) for the purpose of registering a motor vehicle in his name;
or
- (b) on any vehicle registered under his name upon payment of a fee of \$321 (inclusive of GST) for the cancellation of the index mark which has been assigned to that vehicle under rule 14.

(9) Upon an application by the successful applicant, regardless of whether the period specified in paragraph (8) has lapsed, the Registrar may extend (or further extend) that period by a further period of 6 months for each application.

(10) Every application for an extension of time under paragraph (9) shall —

(a) be accompanied by —

(i) an extension fee of \$1,000; and

(ii) a processing fee of \$32.10 (inclusive of GST); and

[S 696/2017 wef 20/12/2017]

(b) unless the Registrar allows otherwise, be made and posted within such time as to be received by the Registrar at least 7 days before the period specified in paragraph (8) lapses or, where any extension of time is granted, the last extension of time lapses.

(11) [*Deleted by S 456/2012*]

(12) Where a successful applicant fails to comply with the requirements of paragraph (8) within the period specified in that paragraph or within any extension of such period as may have been granted to him under paragraph (9) —

(a) he shall not be entitled to the use of the index mark and registration number earlier allotted to him;

(b) the deposit which has been paid by him under paragraph (2)(b) shall be forfeited; and

(c) the Registrar may then assign the index mark and registration number for the registration of any other motor vehicle or for further bidding.

(13) The Registrar may, in his discretion and subject to such conditions as he thinks fit, upon the request of a successful applicant and payment of a fee of \$32.10 (inclusive of GST), assign or transfer to any person the index mark and registration number allotted to the applicant.

[S 696/2017 wef 20/12/2017]

(14) Any deposit paid under paragraph (2)(b) by an unsuccessful applicant shall be refunded to him without interest within 2 weeks of the determination of the successful applications or such other time as the Registrar may decide.

(15) Notwithstanding anything in this rule, the Registrar may, in his discretion and subject to such conditions as he thinks fit to impose, do either or both of the following:

- (a) waive, in whole or in part, payment of any extension fee referred to in paragraph (10)(a)(i) or any fee referred to in sub-paragraph (b);
- (b) at the request of a successful applicant and upon payment of a fee of \$32.10 (inclusive of GST), do all or any of the following:
 - (i) cancel the index mark and registration number allotted to the applicant;
 - (ii) refund to the applicant any deposit paid under paragraph (2)(b) in respect of that index mark and registration number;
 - (iii) cancel any extension of time granted to the applicant under paragraph (9);
 - (iv) refund to the applicant a pro-rated amount of the extension fee paid under paragraph (10)(a)(i) in respect of that extension of time according to the proportion which the remaining period of the extension (rounded to the nearest day) bears to the total period of that extension.

[S 696/2017 wef 20/12/2017]

Applications for Registrar to assign index marks and registration numbers for existing motor vehicles

16A.—(1) The Registrar may, on the application of the registered owner of a motor vehicle —

- (a) assign an index mark and a registration number in place of the index mark and registration number assigned to that

motor vehicle and cancel the mark and number to be replaced; or

- (b) assign an index mark and a registration number in addition to the index mark and registration number assigned to that motor vehicle.

(2) Every application under paragraph (1) shall be —

- (a) made in such form as may be required by the Registrar; and
- (b) accompanied by a fee of \$321 (inclusive of GST).

(3) The Registrar may require any person making an application under paragraph (1) to submit such other information or comply with such other conditions as the Registrar may specify.

(4) The Registrar may, in his discretion, reject any application under paragraph (1) without assigning any reason.

(5) Where the Registrar has granted an application under paragraph (1) —

- (a) that application shall not be withdrawn; and
- (b) the fee paid in respect of that application shall not be refunded.

(6) The Registrar may, in his discretion, waive, in whole or in part, the fee payable under paragraph (2)(b).

Identification mark

17.—(1) The identification mark to be carried by a motor vehicle shall —

- (a) consist of —
 - (i) the index mark and the registration number assigned to that motor vehicle; or
 - (ii) where 2 sets of index mark and registration number have been assigned to that motor vehicle, either of those sets of index mark and registration number; and

(b) be exhibited on a flat rectangular plate or on a flat unbroken rectangular surface forming part of the motor vehicle.

(2) In each case the identification mark shall conform to the specifications set out in Diagrams 1, 2, 3 and 4 of the Fourth Schedule, except that —

- (a) in the case of motor cycles, the identification mark shall conform to Diagrams 5, 6, 7, 8 and 9 of that Schedule;
- (b) in the case of off-peak cars, the identification mark shall conform to Diagrams 10 and 11 of that Schedule;
- (c) [*Deleted by S 365/2012*]
- (d) in the case of PU-registered vehicles other than motor cycles and scooters, the identification mark shall conform to Diagrams 14 and 15 of that Schedule unless otherwise required by the Registrar;
- (e) in the case of motor cycles and scooters which are registered as PU-registered vehicles, the identification mark shall conform to Diagrams 16 and 17 of that Schedule unless otherwise required by the Registrar;
- (f) in the case of vehicles transporting petroleum or flammable materials licensed under the Fire Safety (Petroleum and Flammable Materials) Regulations (Cap. 109A, Rg 7), the identification mark shall conform to Diagrams 1 and 2 of that Schedule and shall be formed of black letters and figures against an orange background, unless otherwise required by the Registrar;
- (g) in the case of de-registered vehicles referred to in rule 34B, the identification mark shall conform to Diagrams 10 and 11 of that Schedule and shall be formed of letters and figures against a brown background, unless otherwise required by the Registrar;
- (h) in the case of unregistered vehicles referred to in rule 34C, the identification mark shall conform to Diagrams 10 and 11 of that Schedule and shall be formed of the word

“DISPLAY” against a brown background, unless otherwise required by the Registrar or the identification mark is one that is approved and affixed to a foreign vehicle at the time the foreign vehicle is brought into Singapore for the purposes of rule 34C;

- (i) in the case of normal vintage vehicles which are motor cycles or scooters, the identification mark shall conform to Diagrams 5, 6 and 7 of that Schedule;
- (j) in the case of normal vintage vehicles which are motor cars, the identification mark shall conform to Diagrams 1 and 2 of that Schedule;
- (k) in the case of classic vehicles, restricted vintage vehicles or revised use vintage vehicles which are motor cycles or scooters, the identification mark shall conform to Diagrams 20, 21 and 22 of that Schedule; and
- (l) in the case of classic vehicles, restricted vintage vehicles or revised use vintage vehicles which are motor cars, the identification mark shall conform to Diagrams 12 and 13 of that Schedule.

(3) Where the sealing or re-sealing of an index mark and a registration number or an identification mark is required, the registered owner shall, within 3 calendar days after the specified date referred to in paragraph (4), or such further period as the Registrar may allow, furnish proof to the Registrar that the identification mark of his motor vehicle has conformed to the requirements of paragraph (2).

(4) In paragraph (3), “specified date”, in relation to the motor vehicle referred to in that paragraph, means the date —

- (a) the motor vehicle is registered or re-registered in Singapore;
- (b) the motor vehicle is licensed or re-licensed under these Rules;
- (c) the motor vehicle has been assigned an identification mark under rule 22;

- (d) the motor vehicle has been assigned an index mark and a registration number under rule 16A(1)(a); or
- (e) the Registrar has given authorisation under rule 24 for any seal affixed to the motor vehicle to be removed or broken.

Position of identification mark

18.—(1) Subject to paragraph (2), the identification mark shall be exhibited at the front and at the back of the motor vehicle not more than one metre from the ground in a vertical position so that every letter or figure of the identification mark is vertical and easily distinguishable —

- (a) in the case of letters and figures placed at the front of the motor vehicle, from the front of the motor vehicle; and
- (b) in the case of letters and figures placed at the back of the motor vehicle, from behind the motor vehicle.

(2) In the case of a motor cycle, the identification mark exhibited on a plate fixed on the front of the vehicle shall —

- (a) be exhibited not more than 1.5 metres from the ground (when the motor cycle is unladen) in a vertical position so that every letter or figure of the identification mark is vertical and easily distinguishable from the front of the motor cycle; or
- (b) if it is a plate having duplicate faces conforming with Diagram 5 of the Fourth Schedule, be fixed so that from whichever side the motor cycle is viewed the letters and figures on one or other face of the plate are easily distinguishable although they may not be distinguishable from the front of the vehicle.

Identification mark not to be obstructed

19. No other figures or letters and no design advertisement or ornamentation shall be placed near the identification mark in such a manner as to be liable to render it more difficult to read or distinguish the identification mark of the motor vehicle when in motion.

Identification marks on trailers, etc.

20. When one or more vehicles of any kind are attached to a mechanically propelled motor vehicle either in front or behind the identification mark required to be exhibited at the front or at the back of the mechanically propelled vehicle, a duplicate of the identification mark shall be exhibited at the front or at the back of the foremost or rearmost vehicle attached as the case requires in the same manner as the identification mark is required to be fixed upon the motor vehicle drawing or propelling the vehicle.

Illumination of identification mark

21.—(1) Whenever a motor vehicle is on a road between sunset and sunrise, the identification mark exhibited at the back of the motor vehicle or at the rearmost vehicle drawn by the motor vehicle shall be adequately illuminated as to render easily distinguishable every letter and figure of the identification mark.

(2) It shall not be necessary for a motor vehicle to comply with paragraph (1) while it is parked on an adequately lighted road.

Assignment of identification mark

22.—(1) Subject to paragraph (10), the registered owner of a vehicle may apply to the Registrar in such manner and within such period as the Registrar may require to have the identification mark of the vehicle assigned to another vehicle —

- (a) which has not previously been registered under these Rules and in respect of which he applies or has applied to be registered as owner in accordance with these Rules;
- (b) which has not previously been registered under these Rules and in respect of which he intends to apply to be registered as owner in accordance with these Rules;
- (c) which is registered in his name under these Rules;
- (d) which has been registered in the name of another person under these Rules and in respect of which he intends to apply to be registered as owner in accordance with these Rules;

- (e) which has not previously been registered under these Rules and in respect of which such person as the Registrar may in his discretion permit in any particular case, other than the registered owner of the first-mentioned vehicle, applies or has applied to be registered as owner in accordance with these Rules; or
 - (f) which is registered under these Rules in the name of such person as the Registrar may in his discretion permit in any particular case, other than the registered owner.
- (2) In an application under paragraph (1), the Registrar may require the applicant to furnish to the Registrar such documents or information relating to —
- (a) the first-mentioned vehicle;
 - (b) the second-mentioned vehicle;
 - (c) the application; and
 - (d) in the case of paragraph (1)(e) or (f), the person who applies or has applied to be registered, or is registered, as the owner of the second-mentioned vehicle, and the applicant's relationship with that person.
- (3) The Registrar may, in his discretion and subject to such terms and conditions as he may impose, approve the assignment of the identification mark to the second-mentioned vehicle —
- (a) in the case mentioned in paragraph (1)(a), upon being paid a fee of \$100;
 - (b) in a case mentioned in paragraph (1)(b), (c) or (d), upon being paid a fee of \$1,300;
 - (c) in the case mentioned in paragraph (1)(e), upon being paid a retention fee of \$100 and a processing fee of \$32.10 (inclusive of GST); or

[S 696/2017 wef 20/12/2017]

- (d) in the case mentioned in paragraph (1)(f), upon being paid a retention fee of \$1,300 and a processing fee of \$32.10 (inclusive of GST).

[S 696/2017 wef 20/12/2017]

(4) The Registrar shall notify every applicant of the result of his application and, where the Registrar has approved the assignment of the identification mark under paragraph (3), the date of such approval.

(5) A successful applicant shall, within 12 months from the date referred to in paragraph (4), begin to use the identification mark on the second-mentioned vehicle.

(6) The Registrar may, in his discretion, extend the period referred to in paragraph (5) from time to time, but each extension of that period shall not exceed 6 months.

(7) Every application for an extension of time under paragraph (6) shall be —

(a) accompanied by payment of —

(i) an extension fee of \$1,000; and

(ii) a processing fee of \$32.10 (inclusive of GST); and

[S 696/2017 wef 20/12/2017]

(b) unless the Registrar allows otherwise, made and posted within such time as to be received by the Registrar at least 7 days before the expiry of the period referred to in paragraph (5) or the last extension of that period, as the case may be.

(8) Where a successful applicant fails to comply with the requirements of paragraph (5) within the period specified in that paragraph or any extension of such period as may have been granted to him under paragraph (6), he shall not be entitled —

(a) to use the identification mark; and

(b) to a refund of any fee paid under this rule.

(9) Except in the case mentioned in paragraph (8), the Registrar may, in his discretion and subject to such terms and conditions as he may impose —

- (a) waive, in whole or in part, any fee payable under paragraph (3) or (7)(a); or
- (b) at the request of a successful applicant and upon being paid a fee of \$32.10 (inclusive of GST) —
 - (i) cancel the identification mark assigned to the applicant; and
 - (ii) refund any fee paid under paragraph (3) or (7)(a)(i).

[S 696/2017 wef 20/12/2017]

(10) The registered owner of a vehicle shall not be entitled to apply under paragraph (1) to have the identification mark of the vehicle assigned so long as the registration of the vehicle remains the subject of a temporary transfer under rule 25(4) or 26(1).

23. *[Deleted by S 131/2013]*

Tampering with seals

24. It shall be an offence for anyone, except a person authorised by the Registrar, to remove, break or tamper with a seal affixed under these Rules.

PART IV

TRANSFER OF VEHICLES

Transfer of vehicle registration

25.—(1) Where the owner of a registered vehicle transfers possession of the vehicle with the intention of transferring the registration of the vehicle to the name of another person (referred to in this rule as the transferee), the owner of the registered vehicle or the transferee shall, not later than 7 days from the transfer of possession, make an application to the Registrar for the registration of the vehicle to be transferred to the name of the transferee.

(2) Any application for a transfer of the registration of a vehicle shall be made in such form and manner as the Registrar may require and shall be accompanied by —

(a) the total of all the following fees:

- (i) the prescribed fee in Part IV of the First Schedule;
- (ii) the fee payable under rule 31(1), subject to the minimum fee mentioned in that rule;
- (iii) the fee payable under rule 31(4), in respect of a motor vehicle mentioned in that rule; or

[S 327/2017 wef 25/06/2017]

(b) the balance amount after setting off the rebate under rule 38C (where applicable) against the total fee mentioned in sub-paragraph (a).

[S 327/2017 wef 25/06/2017]

(c) *[Deleted by S 327/2017 wef 25/06/2017]*

(3) Where no application is made to the Registrar to transfer the registration of a vehicle to the name of the transferee within the time delimited by paragraph (1), the owner of the vehicle and the transferee shall each be guilty of an offence.

(3A) The Registrar may require the owner of a registered vehicle or a transferee to furnish such additional information relating to the vehicle or the transfer as the Registrar may specify.

(4) Where —

- (a) the owner of a registered vehicle sells the vehicle to a firm or a company which deals in secondhand motor vehicles; and
- (b) the firm or company has bought the registered vehicle for the purpose of resale,

the Registrar may, upon —

- (i) the application made by the firm or company in such form or manner as the Registrar may require; and

- (ii) the payment of a fee of \$25,

[S 696/2017 wef 20/12/2017]

temporarily transfer the registration of the vehicle to the name of such firm or company for a period not exceeding 3 months, subject to such conditions as the Registrar may think fit to impose.

(5) Where the firm or company referred to in paragraph (4) has not sold the vehicle to another person at the expiration of the 3-month period referred to in that paragraph, the Registrar may —

- (a) extend the period of registration of the vehicle in the name of the firm or company for a further period of 3 months upon the payment of a fee of \$30;
- (b) at the expiration of the 3-month period referred to in sub-paragraph (a), extend the period of registration of the vehicle in the name of the firm or company for a further period of 3 months upon the payment of a fee of \$60; and
- (c) at the expiration of the 3-month period referred to in sub-paragraph (b), extend the period of registration of the vehicle in the name of the firm or company for a further period of 3 months upon the payment of —
 - (i) a fee of \$90, if the 3-month period referred to in sub-paragraph (b) expired on or after 25th May 2009 but before 24th February 2011; or
 - (ii) a fee of \$60, if the 3-month period referred to in sub-paragraph (b) expires on or after 7th March 2013,

subject to such conditions as the Registrar may in his discretion impose.

(5A) Paragraph (5)(c) shall not apply to —

- (a) any vehicle where the 3-month extension of the period of registration of the vehicle in the name of the firm or company as extended under paragraph (5)(b) had expired before 25th May 2009; or
- (b) any vehicle the registration of which is temporarily transferred to the name of such firm or company referred

to under paragraph (4) on or after 25th May 2010 but before 8th June 2012.

(6) Where —

- (a) the Registrar does not extend the period of registration of the vehicle under paragraph (5)(a), (b) or (c), as the case may be;
- (b) any period of extension granted by the Registrar under any of those paragraphs has expired; and
- (c) the firm or company has not before the expiration of that period of extension transferred the registration of the vehicle to another person,

then, at the expiration of that period of extension, the firm or company shall transfer the registration of the vehicle to its name and pay —

- (i) the prescribed fee in Part IV of the First Schedule;
- (ii) the fee payable under rule 31(1), subject to the minimum fee referred to in that rule; and
- (iii) the fee payable under rule 31(4), in respect of a motor vehicle referred to in that rule.

(7) The Registrar may require such motor vehicle to be subjected to mechanical inspection before he approves the transfer.

(8) Subject to rule 29, no motor vehicle which has been first registered as —

- (a) a private motor car;
- (b) a business service passenger vehicle;
- (c) a private hire car; or
- (d) a taxi,

using a certificate of entitlement issued on or after 1st April 1995 under rule 3(1)(a) or (b) of the Road Traffic (Motor Vehicles, Quota System) Rules (R 31) shall be transferred to another person unless —

- (i) a period of 3 months has elapsed from the date of its first registration; or

- (ii) the transfer, if made within a period of 3 months from the date of the first registration of the vehicle, is approved by the Registrar.

(9) The Registrar may, in his discretion, refuse to approve the transfer of a light goods vehicle (other than a goods-cum-passengers vehicle) or a small bus unless he is satisfied that —

- (a) it will, after the transfer, be registered under a person specified in rule 3C(1) or (2); and
- (b) the person referred to in sub-paragraph (a) has complied or has undertaken to the Registrar to comply with rule 45C(1), (2) or (3), as the case may be.

(9A) Where the Registrar has approved a person's transfer of registration under paragraph (8)(ii), the Registrar may, for a period not exceeding one year commencing from the date of that approval, refuse any other application from that person to transfer a vehicle registration to his name.

(10) Upon approval of the transfer, the Registrar shall make the necessary alterations in the register of vehicles.

(11) The Registrar may, in his discretion and subject to such conditions as he thinks fit, waive in whole or in part any fee referred to in paragraph (4)(ii) or (5).

Temporary transfer of vehicle to finance firm or company or insurer, etc.

26.—(1) Where —

- (a) a firm or a company has repossessed a registered vehicle which is under a hire-purchase agreement or any other financing arrangement for the purpose of selling the vehicle or letting the vehicle to another hirer under another agreement or arrangement; or
- (b) an insurer registered under the Insurance Act (Cap. 142) has taken over a registered vehicle from an insured under a policy of insurance for the purpose of settlement of an insurance claim,

the Registrar may, upon —

- (i) the application made by the firm or company or insurer in such form or manner as the Registrar may require; and
- (ii) receiving payment of a fee of \$25,

[S 696/2017 wef 20/12/2017]

temporarily transfer the registration of the vehicle to the name of such firm or company or insurer for a period not exceeding 3 months, subject to such conditions as the Registrar may think fit to impose.

(2) Where the firm or company or insurer referred to in paragraph (1) has not transferred the registration of the vehicle to another person at the expiration of the 3-month period referred to in that paragraph, the Registrar may —

- (a) extend the period of registration of the vehicle in the name of the firm or company or insurer for a further period of 3 months upon the payment of a fee of \$30;
- (b) at the expiration of the 3-month period referred to in sub-paragraph (a), extend the period of registration of the vehicle in the name of the firm or company or insurer for a further period of 3 months upon the payment of a fee of \$60; and
- (c) at the expiration of the 3-month period referred to in sub-paragraph (b), extend the period of registration of the vehicle in the name of the firm or company or insurer for a further period of 3 months upon the payment of —
 - (i) a fee of \$90, if the 3-month period referred to in sub-paragraph (b) expired on or after 25th May 2009 but before 24th February 2011; or
 - (ii) a fee of \$60, if the 3-month period referred to in sub-paragraph (b) expires on or after 7th March 2013,

subject to such conditions as the Registrar may in his discretion impose.

(2A) Paragraph (2)(c) shall not apply to —

- (a) any vehicle where the 3-month extension of the period of registration of the vehicle in the name of the firm or company or insurer as extended under paragraph (2)(b) had expired before 25th May 2009; or
- (b) any vehicle the registration of which is temporarily transferred to the name of such firm or company or insurer referred to under paragraph (1) on or after 25th May 2010 but before 8th June 2012.

(3) Where —

- (a) the Registrar does not extend the period of registration of the vehicle under paragraph (2)(a), (b) or (c), as the case may be;
- (b) any period of extension granted by the Registrar under any of those paragraphs has expired; and
- (c) the firm or company or insurer has not before the expiration of that period of extension transferred the registration of the vehicle to another person,

then, at the expiration of that period of extension, the firm or company or insurer shall transfer the registration of the vehicle to its name and pay —

- (i) the prescribed fee in Part IV of the First Schedule;
- (ii) the fee payable under rule 31(1), subject to the minimum fee referred to in that rule; and
- (iii) the fee payable under rule 31(4), in respect of a motor vehicle referred to in that rule.

(4) The Registrar may, in his discretion, refuse to approve the transfer of a light goods vehicle (other than a goods-cum-passengers vehicle) or a small bus to a person referred to in paragraph (3) unless he is satisfied that —

- (a) it will, after the transfer, be registered under a person specified in rule 3C(1) or (2); and

(b) the person referred to in sub-paragraph (a) has complied or has undertaken to the Registrar to comply with rule 45C(1), (2) or (3), as the case may be.

(5) The Registrar may, in his discretion and subject to such conditions as he thinks fit, waive in whole or in part any fee referred to in paragraph (1)(ii) or (2).

Transfer of business service passenger vehicle

27.—(1) Subject to paragraph (2), a motor car which is registered as a business service passenger vehicle shall not be transferred to and registered in the name of an individual for use as a private motor car.

(2) Paragraph (1) shall not prohibit the transfer to an individual of a motor car which is registered in the name of —

- (a) a firm or a company which has repossessed the motor car under a hire-purchase agreement or any other financing arrangement for the purpose of selling that motor car or letting it to another hirer under another agreement or arrangement;
- (b) a firm or a company which deals in secondhand motor vehicles and has bought the motor car for the purpose of resale; and
- (c) an insurer registered under the Insurance Act (Cap. 142) which has taken over a registered vehicle from an insured under a policy of insurance for the purpose of settlement of an insurance claim.

(3) Any individual who is prohibited under paragraph (1) from having a business service passenger vehicle transferred to and registered in his name as a private motor car and who keeps or is in possession of the vehicle for more than 7 days after purchasing it shall be guilty of an offence.

(4) Paragraph (1) shall not apply to the transfer of any motor car effected on or after 1st April 1998 or to the registration of any motor car using a certificate of entitlement issued on or after 1st April 1998.

Heavy vehicle not to be transferred without vehicle parking certificate

28.—(1) No heavy vehicle shall be transferred to or registered in the name of any person unless he has been issued with a vehicle parking certificate in respect of the heavy vehicle by the relevant authority under the Parking Places Act (Cap. 214) for the period for which the heavy vehicle is to be licensed.

(2) Any person who is prohibited under paragraph (1) from having a heavy vehicle transferred to or registered in his name and who keeps or is in possession of the heavy vehicle for more than 7 days after purchasing the heavy vehicle shall be guilty of an offence.

Transfer on death of owner

29.—(1) The Registrar may transfer the registration of a motor vehicle to the name of another person if that person makes an application for the transfer of registration of the motor vehicle to his name.

(1A) [*Deleted by S 66/2012*]

(2) The application referred to in paragraph (1) must be accompanied by —

- (a) proof that the registered owner of the vehicle is dead;
- (b) proof that the applicant is reasonably entitled thereto, through the production of the probate of will or letters of administration granted to any person for the estate of the deceased registered owner of the vehicle or a certified true copy of the probate of will or letters of administration; and
- (c) the payment of —
 - (i) the fee specified in Part IV of the First Schedule;
 - (ii) the fee payable under rule 31(1), subject to the minimum fee referred to in that rule; and
 - (iii) the fee payable under rule 31(4), in respect of a motor vehicle referred to in that rule.

(3) The transfer of registration shall be subject to such conditions as the Registrar thinks necessary to impose.

(4) The Registrar may, in his discretion, refuse to approve the transfer of a light goods vehicle (other than a goods-cum-passengers vehicle) or a small bus unless he is satisfied that —

(a) it will, after the transfer, be registered under a person specified in rule 3C(1) or (2); and

(b) the person referred to in sub-paragraph (a) has complied or has undertaken to the Registrar to comply with rule 45C(1), (2) or (3), as the case may be.

(5) Notwithstanding paragraph (2), the Registrar may, in his discretion and subject to such conditions as he thinks fit, waive the fee payable under rule 31(1), or the fee payable under rule 31(4) in respect of a motor vehicle referred to in that rule, or both.

Transfer fee

30.—(1) The fee payable on the transfer of registration of a vehicle shall be that specified in Part IV of the First Schedule.

(2) The Registrar may, in his discretion, waive in whole or in part the fee referred to in paragraph (1).

Sums payable upon transfer of vehicle registration

31.—(1) In addition to the fee payable under rule 30, a fee of 2% of the value of a vehicle shall be payable on every transfer of registration of the vehicle which occurred before 18th February 2012, subject to a minimum fee of \$5 in the case of a motor cycle and \$20 in the case of any other motor vehicle.

(2) [*Deleted by S 125/2006*]

(3) The value of the vehicle for the purpose of paragraph (1) shall be determined by the Registrar whose decision shall be final.

(4) Notwithstanding paragraph (1), where the registration of a motor vehicle which has been first registered as a private motor car, a business service passenger vehicle, a private hire car or a taxi using a certificate of entitlement issued on or after 1st April 1995 under

rule 3(1)(a) or (b) of the Road Traffic (Motor Vehicles, Quota System) Rules (R 31) is transferred within a period of 6 months from the date of its first registration, there shall be payable, in respect of at least one transfer of registration during that period, a fee equivalent to any positive difference derived by deducting —

- (a) the quota premium paid for the certificate of entitlement for the vehicle; from
- (b) the quota premium as determined by the Registrar to be payable at the time of the transfer of registration for a certificate of entitlement for a motor vehicle of the appropriate cylinder capacity.

(5) The Registrar may, in his discretion and subject to such conditions as he thinks fit, waive any fee payable under paragraph (1) or (4) or both.

Sale or disposal of certain vehicles

31A. The registered owner of a vehicle shall first obtain the approval of the Registrar before selling or disposing of any of the following vehicles:

- (a) a motor vehicle approved by the Minister to be registered in the name of a disabled person;
- (b) a normal vintage vehicle;
- (c) a restricted vintage vehicle.

PART V

REGISTRATION AND RE-REGISTRATION OF OFF-PEAK AND ELECTRIC CARS, ETC.

Registration of off-peak cars

32.—(1) Subject to these Rules, a private individual, company, firm, society, club or an association may register a motor car as an off-peak car.

(2) Section 11A of the Act shall apply to a motor car which is registered as an off-peak car.

(3) This rule shall not apply to a motor car registered in the name of a company, firm, society, club or an association using a certificate of entitlement issued before 1st April 1998.

Re-registration before 25th January 2010 of private motor cars as off-peak cars and vice versa

33.—(1) The Registrar may, upon application in an approved form and on payment of a prescribed conversion fee of \$100, re-register a private motor car as an off-peak car.

(2) The owner of a private motor car which has been re-registered as an off-peak car on or after 1st October 1994 may, subject to paragraph (3), upon the de-registration of the car apply for a rebate in addition to that referred to in rule 8(1).

(3) No person shall be entitled to the rebate referred to in paragraph (2) unless he qualifies for the rebate under rule 8.

(4) The rebate referred to in paragraph (2) shall be calculated in accordance with the following formula:

$$A \times \frac{\$2,200}{12}$$

where A is the period or periods (in months) commencing from 1st October 1994 for which the private motor car has been registered as an off-peak car.

(5) The Registrar may, upon application in an approved form and on payment of the conversion fee and conversion premium specified in paragraph (6), re-register an off-peak car as a private motor car except that no off-peak car in respect of which a category (f) certificate of entitlement has been issued may be re-registered as a private motor car under this rule after 30th September 1997 and before 2nd October 2000.

(6) For the purpose of paragraph (5) —

(a) in the case of a private motor car which has been re-registered as an off-peak car before 1st September 1994 —

(i) the conversion fee is \$100; and

- (ii) no conversion premium is payable;
- (b) in the case of a private motor car which has been re-registered as an off-peak car on or after 1st October 1994 —
 - (i) the conversion fee is \$800 if the car is re-registered as a private motor car before 3rd March 2004, and \$100 if it is re-registered on or after 3rd March 2004; and
 - (ii) no conversion premium is payable;
- (c) in the case of an off-peak car in respect of which a certificate of entitlement has been issued —
 - (i) the conversion fee is \$800 if the car is re-registered as a private motor car before 3rd March 2004, and \$100 if it is re-registered on or after 3rd March 2004; and
 - (ii) the conversion premium shall be the conversion charge computed according to the formula set out in rule 22(1)(b) of the Road Traffic (Motor Vehicles, Quota System) Rules (R 31); and
- (d) in any other case —
 - (i) the conversion fee is \$800 if the car is re-registered as a private motor car before 3rd March 2004, and \$100 if it is re-registered on or after 3rd March 2004; and
 - (ii) the conversion premium shall be determined in accordance with the following formula:

$$\frac{A \times B}{C}$$

where A is the sum of the rebate on customs duties granted in respect of that motor car under section 16 of the Customs Act (Cap. 70), the rebate on the quota premium granted under rule 14(2) of the Road Traffic (Motor Vehicles, Quota System) Rules and the rebate on the additional

registration fee granted under rule 9(3) in respect of the motor car at the time it was registered as an off-peak car;

B is 120 months less the period (in months) for which the motor car has been registered in Singapore at its re-registration as a private motor car; and

C is 120 months.

(7) This rule shall not apply to any —

(a) private motor car which, on or after 25th January 2010, is re-registered as an off-peak car; or

(b) off-peak car which, on or after 25th January 2010, is re-registered as a private motor car.

33A. [*Deleted by S 365/2012*]

Re-registration of conventional cars as electric cars, petrol-electric cars or diesel-electric cars

33B.—(1) Upon the application by the owner of a conventional car in the form determined by the Registrar, the Registrar may, if satisfied that the conventional car has been converted into an electric car, a petrol-electric car or a diesel-electric car, re-register the conventional car as an electric car, a petrol-electric car or a diesel-electric car, as the case may be.

(2) In granting an application under paragraph (1), the Registrar may impose such conditions as he thinks fit.

Re-registration of petrol-electric cars or diesel-electric cars as electric cars

33C.—(1) Upon the application by the owner of a petrol-electric car or a diesel-electric car in the form determined by the Registrar, the Registrar may, if satisfied that the petrol-electric car or the diesel-electric car has been converted into an electric car, re-register the petrol-electric car or the diesel-electric car as an electric car.

(2) In granting an application under paragraph (1), the Registrar may impose such conditions as he thinks fit.

Re-registration of business service passenger vehicles as private motor cars or tuition cars

33D.—(1) The Registrar may, in his discretion, upon application in an approved form by the owner of a business service passenger vehicle that falls within any of the classes specified in paragraph (2), re-register the business service passenger vehicle as —

(a) a private motor car; or

[S 550/2017 wef 01/10/2017]

(b) a tuition car.

[S 550/2017 wef 01/10/2017]

(2) The classes of business service passenger vehicles to which paragraph (1) applies are —

(a) a business service passenger vehicle which has been registered using a certificate of entitlement issued on or after 1st April 1998; and

(b) a business service passenger vehicle which —

(i) before 1st April 1998, was registered as a private motor car; and

(ii) on or after that date, was transferred to and re-registered in the name of any statutory board, company, firm, society, club or association as a business service passenger vehicle.

(3) The Registrar may, in his discretion, upon application in an approved form by the owner of a motor vehicle that has been registered as a private motor car or a tuition car under paragraph (1), re-register that motor vehicle as a business service passenger vehicle.

[S 550/2017 wef 01/10/2017]

(4) In granting an application under paragraph (1) or (3), the Registrar may impose such conditions as he thinks fit.

[S 550/2017 wef 01/10/2017]

Re-registration on or after 25th January 2010 of private motor cars, etc., as off-peak cars

33E.—(1) As from 25th January 2010, the registered owner of any of the following vehicles may apply to the Registrar for the vehicle to be re-registered as an off-peak car under this rule (referred to in this rule as a “new scheme off-peak car”):

- (a) any private motor car;
- (b) any business service passenger vehicle registered using a certificate of entitlement issued on or after 1st April 1998;
- (c) any private motor car which has been transferred on or after 1st April 1998 to a statutory board, company, firm, society, club or an association;
- (d) any motor car which has been registered as an off-peak car under rule 32;
- (e) any private motor car which has been re-registered as an off-peak car under rule 33.

(2) An application under paragraph (1) shall be made in such form and manner as the Registrar may require, and shall be accompanied by a fee of \$100.

(3) The Registrar may impose such conditions as he thinks fit when granting an application made under paragraph (1).

(4) Subject to paragraphs (6), (7) and (8), the registered owner of a vehicle referred to in paragraph (1)(a), (b), (c) or (e) in respect of which any applicable conversion premium under rule 33(5) or 33F(4) (as the case may be) has been paid to the Registrar shall —

- (a) for the initial period of 6 consecutive months beginning from the date of the re-registration (referred to in this rule as the “eligibility period”) during which the vehicle continues to be a new scheme off-peak car; and
- (b) for each subsequent period of 6 consecutive months or part thereof (referred to in this rule as the “rebate period”) during which the vehicle continues to be a new scheme off-peak car after the eligibility period,

be entitled to a rebate of \$1,100 or of an amount calculated in accordance with the formula set out in paragraph (5), whichever is the lower.

(5) The formula to be applied for the purposes of paragraph (4) shall be as follows:

$$A \times \frac{\left[\frac{B + C - D + E}{\$17,000} \right]}{6} \times \$1,100$$

where A is the period (in months) during the eligibility period or any rebate period (as the case may be) for which the vehicle continues to be a new scheme off-peak car;

B is the quota premium payable under the Road Traffic (Motor Vehicles, Quota System) Rules (R 31) for a certificate of entitlement in respect of the vehicle;

C is the fee payable under rule 7 in respect of the vehicle;

D is the rebate granted by the Registrar under rule 9A, 9B, 9C or 10 in respect of the vehicle; and

E is the conversion premium payable to the Registrar under rule 9B(9)(b) in respect of any application made to him under rule 9B(8) (if applicable).

[S 263/2021 wef 01/01/2018]

(6) The Registrar shall pay the rebate provided for under paragraph (4) to the registered owner of a new scheme off-peak car at the end of the eligibility period or each rebate period, as the case may be, except that —

- (a) if within the eligibility period or any rebate period the new scheme off-peak car attains the age of 10 years or is de-registered, the rebate for that period shall be payable to the registered owner of the vehicle on a pro-rata basis upon the happening of the event;
- (b) if within the eligibility period or any rebate period the new scheme off-peak car is —

- (i) reported as having been lost through theft or criminal breach of trust; or
 - (ii) seized by any authority under any written law, the Registrar may, upon the expiry of that period and subject to such conditions as the Registrar thinks fit to impose, pay to the registered owner of the vehicle the rebate that has accrued in respect of that part of that period before the vehicle was reported lost or seized;
 - (c) if within the eligibility period the new scheme off-peak car is re-registered as a private motor car or a business service passenger vehicle, no rebate shall be payable to the registered owner of the vehicle in respect of that period;
 - (d) if within any rebate period the new scheme off-peak car is re-registered as a private motor car or a business service passenger vehicle, the rebate for that period shall be payable to the registered owner of the vehicle on a pro-rata basis upon the happening of the event; and
 - (e) if within the eligibility period or any rebate period the new scheme off-peak car is declared non-user under rule 53, the rebate for that period shall be payable to the registered owner of the vehicle on a pro-rata basis (discounting any period of non-user) at the expiry of that period.
- (7) If the vehicle referred to in paragraph (6)(b) is recovered or released (as the case may be) and the registered owner of the vehicle takes out a licence in respect of the vehicle under rule 38, the Registrar shall —
- (a) where the eligibility period or rebate period during which the vehicle was reported lost or seized has elapsed, pay to the registered owner of the vehicle the amount of the rebate that is payable in respect of that part of that period during which the vehicle is reported lost or seized upon the taking out of the licence under rule 38; or
 - (b) where the eligibility period or rebate period during which the vehicle was reported lost or seized has not elapsed, pay to the registered owner of the vehicle the amount of the

rebate provided for under paragraph (4) at the end of that period.

(8) Where any vehicle to which rule 33(2) applies is re-registered as a new scheme off-peak car under this rule, the Registrar shall, subject to such conditions as he thinks fit to impose, pay to the registered owner of the vehicle a sum of an amount equivalent to the rebate which would have been payable under rule 33(2) had the vehicle been de-registered on the day before the date of its re-registration as a new scheme off-peak car under this rule, and upon such payment, rule 33(2) shall cease to apply in respect of that vehicle.

(9) The Registrar may, in his discretion and subject to such conditions as he thinks fit to impose, waive, in whole or in part, the fee of \$100 payable under paragraph (2).

(10) The Registrar may —

- (a) refuse to make any payment of any rebate provided for under this rule to the registered owner of any new scheme off-peak car unless the Registrar is satisfied that all fees and taxes which are payable in respect of that vehicle under Part I of the Act or these Rules have been paid; or
- (b) set off any fee or tax which is payable in respect of that vehicle under Part I of the Act or these Rules arising from its re-registration as a new scheme off-peak car against any rebate provided for under this rule which is payable to the registered owner of that vehicle.

(11) Where a new scheme off-peak car is reported lost through theft or criminal breach of trust or is seized by any authority under any written law, the registered owner of the new scheme off-peak car shall, within 7 days after the loss or seizure, inform the Registrar in writing of such loss or seizure.

(12) Where the Registrar has paid to the registered owner of a new scheme off-peak car who has failed to comply with paragraph (11) any rebate under this rule which such registered owner would not have been entitled to on account of the loss or seizure of the vehicle, the Registrar may, by notice in writing, require such registered owner

to refund the Registrar for the amount that has been paid to him within such time as may be specified in the notice.

(13) Any registered owner of a new scheme off-peak car who fails, without reasonable excuse, to comply with paragraph (11) or with any notice issued to him by the Registrar under paragraph (12) shall be guilty of an offence.

Re-registration on or after 25th January 2010 of off-peak cars as private motor cars or business service passenger vehicles

33F.—(1) As from 25th January 2010, the registered owner of an off-peak car may apply to the Registrar for the vehicle to be re-registered as a private motor car or business service passenger vehicle under this rule.

(2) An application under paragraph (1) shall be made in such form and manner as the Registrar may require, and shall be accompanied by a fee of \$100.

(3) The Registrar may impose such conditions as he thinks fit when granting an application made under paragraph (1).

(4) Where, on or after 25th January 2010, a motor car which has been registered as an off-peak car under rule 32 is re-registered as a private motor car or business service passenger vehicle under this rule, the registered owner of the vehicle shall pay to the Registrar the conversion premium specified in paragraph (5).

(5) The conversion premium referred to in paragraph (4) shall —

- (a) in the case of an off-peak car in respect of which a category (f) certificate of entitlement has been issued, be the conversion charge computed according to the formula set out in rule 22(1)(b) of the Road Traffic (Motor Vehicles, Quota System) Rules (R 31); or
- (b) in the case of any other type of off-peak car registered on or after 1st October 1994, be determined in accordance with the following formula:

$$\frac{A \times B}{C}$$

where A is the sum of the rebate on customs duties granted in respect of that motor car under section 16 of the Customs Act (Cap. 70), the rebate on the quota premium granted under rule 14(2) of the Road Traffic (Motor Vehicles, Quota System) Rules and the rebate on the additional registration fee granted under rule 9(3) or (4) of these Rules, as the case may be, in respect of the motor car at the time it was registered as an off-peak car;

B is 120 months less the period (in months) for which the motor car has been registered in Singapore at the time of its re-registration as a private motor car or business service passenger vehicle under this rule; and

C is 120 months.

(6) The Registrar may, in his discretion and subject to such conditions as he thinks fit to impose, waive, in whole or in part, the fee of \$100 payable under paragraph (2).

Rebate for secondhand off-peak car registered on or after 1st July 2010

33G.—(1) Where a secondhand vehicle is registered on or after 1st July 2010 as an off-peak car (referred to in this rule as a “new scheme off-peak car”), the registered owner of the new scheme off-peak car shall —

- (a) for the initial period of 6 consecutive months, beginning from the date of the registration (referred to in this rule as the “eligibility period”), during which the vehicle continues to be a new scheme off-peak car; and
- (b) for each subsequent period of 6 consecutive months or part thereof (referred to in this rule as the “rebate period”) during which the vehicle continues to be a new scheme off-peak car after the eligibility period,

be entitled to a rebate of \$1,100 or of an amount calculated in accordance with the formula set out in paragraph (2), whichever is the lower.

(2) The formula to be applied for the purposes of paragraph (1) shall be as follows:

$$A \times \frac{\left[\frac{B + C - D + E}{\$17,000} \right] \times \$1,100}{6}$$

where A is the period (in months) during the eligibility period or any rebate period (as the case may be) for which the vehicle continues to be a new scheme off-peak car;

B is the quota premium payable under the Road Traffic (Motor Vehicles, Quota System) Rules (R 31) for a certificate of entitlement in respect of the vehicle;

C is the fee payable under rule 7 in respect of the vehicle (excluding the additional sum of \$10,000 referred to in rule 7(1A));

D is the rebate granted by the Registrar under rule 9A, 9B, 9C or 10 in respect of the vehicle; and

E is the conversion premium payable to the Registrar under rule 9B(9)(b) in respect of any application made to him under rule 9B(8) (if applicable).

[S 263/2021 wef 01/01/2018]

(3) The Registrar shall pay the rebate provided for under paragraph (1) to the registered owner of a new scheme off-peak car at the end of the eligibility period or each rebate period, as the case may be, except that —

- (a) if within the eligibility period or any rebate period the new scheme off-peak car attains the age of 10 years or is de-registered, the rebate for that period shall be payable to the registered owner of the vehicle on a pro-rata basis upon the happening of the event;
- (b) if within the eligibility period or any rebate period the new scheme off-peak car is —
 - (i) reported as having been lost through theft or criminal breach of trust; or
 - (ii) seized by any authority under any written law,

the Registrar may, upon the expiry of that period and subject to such conditions as the Registrar thinks fit to impose, pay to the registered owner of the vehicle the rebate that has accrued in respect of that part of that period before the vehicle was reported lost or seized;

- (c) if within the eligibility period the new scheme off-peak car is re-registered as a private motor car or a business service passenger vehicle, no rebate shall be payable to the registered owner of the vehicle in respect of that period;
- (d) if within any rebate period the new scheme off-peak car is re-registered as a private motor car or a business service passenger vehicle, the rebate for that period shall be payable to the registered owner of the vehicle on a pro-rata basis upon the happening of the event; and
- (e) if within the eligibility period or any rebate period the new scheme off-peak car is declared non-user under rule 53, the rebate for that period shall be payable to the registered owner of the vehicle on a pro-rata basis (discounting any period of non-user) at the expiry of that period.

(4) If the vehicle referred to in paragraph (3)(b) is recovered or released (as the case may be) and the registered owner of the vehicle takes out a licence in respect of the vehicle under rule 38, the Registrar shall —

- (a) where the eligibility period or rebate period within which the vehicle was reported lost or seized has elapsed, pay to the registered owner of the vehicle the amount of the rebate that is payable in respect of that part of that period within which the vehicle is reported lost or seized upon the taking out of the licence under rule 38; or
- (b) where the eligibility period or rebate period within which the vehicle was reported lost or seized has not elapsed, pay to the registered owner of the vehicle the amount of the rebate provided for under paragraph (1) at the end of that period.

(5) The Registrar may refuse to make any payment of any rebate provided for under this rule to the registered owner of any new scheme off-peak car unless the Registrar is satisfied that all fees and taxes which are payable in respect of that vehicle under Part I of the Act or these Rules have been paid.

(6) Where a new scheme off-peak car is reported lost through theft or criminal breach of trust or is seized by any authority under any written law, the registered owner of the new scheme off-peak car shall, within 7 days after the loss or seizure, inform the Registrar in writing of such loss or seizure.

(7) Where the Registrar has paid to the registered owner of a new scheme off-peak car who has failed to comply with paragraph (6) any rebate under this rule which such registered owner would not have been entitled to on account of the loss or seizure of the vehicle, the Registrar may, by notice in writing, require such registered owner to refund the Registrar for the amount that has been paid to him within such time as may be specified in the notice.

(8) Any registered owner of a new scheme off-peak car who fails, without reasonable excuse, to comply with paragraph (6) or with any notice issued to him by the Registrar under paragraph (7) shall be guilty of an offence.

Re-registration of private hire cars as business service passenger vehicles or private motor cars and vice versa

33H.—(1) The Registrar may, in the discretion of the Registrar, upon application in an approved form and manner and on payment of a prescribed conversion fee of \$100 —

- (a) re-register a business service passenger vehicle as —
 - (i) a chauffeured private hire car; or
 - (ii) a self-drive private hire car;
- (b) re-register a chauffeured private hire car as —
 - (i) a business service passenger vehicle;
 - (ii) a private motor car; or
 - (iii) a self-drive private hire car;

- (c) re-register a private motor car as —
 - (i) a chauffeured private hire car; or
 - (ii) a self-drive private hire car; or
- (d) re-register a self-drive private hire car as —
 - (i) a business service passenger vehicle;
 - (ii) a chauffeured private hire car; or
 - (iii) a private motor car.

(2) The classes of business service passenger vehicles to which paragraph (1)(a) applies are —

- (a) a business service passenger vehicle which has been registered using a certificate of entitlement issued on or after 1 April 1998; and
- (b) a business service passenger vehicle which —
 - (i) before 1 April 1998, was registered as a private motor car; and
 - (ii) on or after that date, was transferred to and re-registered in the name of any statutory board, company, firm, society, club or association as a business service passenger vehicle.

(3) The Registrar may, in the discretion of the Registrar, waive in whole or in part the conversion fee prescribed under paragraph (1).

(4) In granting an application under paragraph (1) or a waiver under paragraph (3), the Registrar may impose any condition.

[S 550/2017 wef 01/10/2017]

Vehicle destroyed, exported or ceased to be kept or used

34.—(1) For the purposes of section 27(1)(d)(ii) of the Act, the prescribed period is one month.

(2) When any vehicle has been destroyed or permanently removed from Singapore, or has ceased to be kept or used on any road in Singapore, the registered owner shall, within 7 days of the occurrence of such event or such longer period as the Registrar may permit —

- (a) notify the Registrar in writing of the event; and
 - (b) show proof to the satisfaction of the Registrar that the vehicle has been destroyed or permanently removed from Singapore or has ceased to be kept or used on any road in Singapore.
- (3) For the purposes of section 27(1)(d)(iv) of the Act, the prescribed period —
- (a) in the case where a vehicle has been reported to the police to be lost through theft, is 3 months after the date of such report; and
 - (b) in the case where a vehicle has been reported on or after 1st January 2005 to the police to be lost through criminal breach of trust, is one year after the date of such report.

Keeping of de-registered vehicles in designated areas

34A.—(1) The Registrar may designate any area for the keeping of de-registered vehicles.

(2) Any person may apply to the Registrar to keep a de-registered vehicle in a designated area for a period of 6 months from the date on which registration of the vehicle is cancelled.

(2A) [*Deleted by S 279/2009*]

(2B) [*Deleted by S 279/2009*]

(3) Subject to paragraphs (4) and (5), where an application under paragraph (2) has been approved, the person may keep the de-registered vehicle only in the designated area approved by the Registrar for keeping the vehicle (referred to in this rule as the approved designated area) and in no other place.

(3A) Notwithstanding paragraph (3), the Registrar may in exceptional circumstances and upon an application being made, permit a de-registered vehicle to be kept at a place other than the approved designated area (referred to in this rule as the alternative area).

(3B) Subject to paragraph (3C), at the end of the 6-month period referred to in paragraph (2), the Registrar may, in his discretion and

subject to such conditions as he thinks fit to impose, extend for a further period of 6 months the period for which a de-registered vehicle may continue to be kept in the approved designated area or the alternative area, as the case may be.

(3C) To obtain the grant of an extension under paragraph (3B) of the period for which a de-registered vehicle may continue to be kept in the approved designated area or the alternative area, as the case may be, the following procedures shall apply:

- (a) if the vehicle was de-registered before 22nd December 2008, an application shall be made to the Registrar for the extension; and
- (b) if the vehicle was de-registered on or after 22nd December 2008, a fee of \$37.45 (inclusive of GST) shall be paid to the Registrar (without any application).

[S 696/2017 wef 20/12/2017]

(3D) Where any part of the 6-month period of extension granted by the Registrar under paragraph (3B) is current on or after 22nd June 2009, the Registrar may, in his discretion, extend a second or third time (and no more) for a period of 6 months each the period for which the vehicle may continue to be kept in the approved designated area or the alternative area, as the case may be, upon an application being made at the end of each period of extension.

(3E) Paragraph (3D) shall not apply to —

- (a) any vehicle which was de-registered before 22nd June 2008;
- (b) any de-registered vehicle in respect of which an application under paragraph (2) was granted before 22nd June 2009; or
- (c) any de-registered vehicle in respect of which an application under paragraph (2) is made on or after 23rd June 2010.

(4) Any person who wishes to move a de-registered vehicle out of an approved designated area or alternative area shall apply to the Registrar for approval to do so.

(5) Any person who wishes to move a de-registered vehicle into an approved designated area or alternative area after it has been moved out of an approved designated area or alternative area under paragraph (4) shall apply to the Registrar for approval to do so.

(6) Every application under paragraph (2), (3A), (3C)(a), (3D), (4) or (5) shall be made in such manner and within such time as the Registrar may require.

(7) Every application under paragraph (2), (3A), (3C)(a), (3D), (4) or (5) shall be accompanied by a fee of \$37.45 (inclusive of GST).

[S 696/2017 wef 20/12/2017]

(8) In approving an application under paragraph (2), (3A), (3D), (4) or (5), the Registrar may impose such conditions as he thinks fit.

(9) Unless the Registrar allows otherwise, a person who has been granted any approval, extension or permission by the Registrar under paragraph (2), (3A), (3B), (3D), (4) or (5) shall immediately affix to the de-registered vehicle which is or is to be kept in the approved designated area or the alternative area a seal, mark or document as determined by the Registrar in such manner as the Registrar may require.

(10) Where the seal, mark or document to be affixed to a de-registered vehicle under paragraph (9) is not affixed to the vehicle in the required manner or, being so affixed, is removed, defaced, altered, mutilated or tampered with —

(a) the person referred to in that paragraph; and

(b) the person who so affixes the seal, mark or document to the vehicle or removes, defaces, alters, mutilates or tampers with the seal, mark or document,

shall both be guilty of an offence.

(11) It shall be a defence for a person referred to in paragraph (9) who is charged with an offence under paragraph (10) to prove that he had taken reasonable steps to prevent the seal, mark or document affixed on the de-registered vehicle from being partially affixed to the vehicle, removed, defaced, altered, mutilated or tampered with.

(12) Any approval, extension or permission granted by the Registrar under paragraph (2), (3A), (3B), (3D), (4) or (5) may be revoked upon the breach of any condition imposed upon such approval, extension or permission.

(13) The Registrar may, in his discretion, waive in whole or in part, the fee payable under paragraph (3C)(b) or (7).

(14) Any person who, for the purpose of obtaining the grant by the Registrar of any approval, extension or permission under paragraph (2), (3A), (3B), (3D), (4) or (5), furnishes to the Registrar (whether in his application or otherwise) any information or particulars which to the person's knowledge are false or in any material respect misleading shall be guilty of an offence.

(15) [*Deleted by S 437/2012*]

Keeping of de-registered vehicles in approved private areas and compounds

34B.—(1) Any person who wishes to keep a de-registered vehicle in any private area or compound may apply to the Registrar for approval to do so.

(2) The Registrar may, in his discretion and subject to such terms and conditions as he thinks fit to impose, grant his approval to the applicant to keep the de-registered vehicle for a period not exceeding 3 years in the private area or compound approved by the Registrar.

(3) The Registrar may, from time to time upon an application being made to him and subject to such terms and conditions as he thinks fit to impose, extend the period for which any approval granted by him under paragraph (2) shall be valid, except that each such extension shall be for a period not exceeding 3 years.

(4) Unless the Registrar allows otherwise, no application under paragraph (3) in respect of any de-registered vehicle shall be accepted if it is received by the Registrar less than 7 days before the period to be extended expires.

(5) Any person who has been granted approval under this rule to keep a de-registered vehicle in a private area or compound approved by the Registrar —

- (a) shall at all times keep the de-registered vehicle within that private area or compound; and
- (b) shall not remove the de-registered vehicle to any other place unless he has applied for and obtained the special approval of the Registrar to do so.
- (6) Subject to paragraph (7), where the identification mark to be affixed to a de-registered vehicle under rule 17(2)(g) is not affixed to the vehicle in the required manner or, being so affixed, is removed, defaced, altered, obscured or tampered with —
- (a) the person to whom approval for the keeping of the vehicle has been granted under this rule; and
- (b) any other person in possession of the vehicle,
- shall both be guilty of an offence.
- (7) The Registrar may waive the requirements under rule 17(2)(g) if the person granted approval to keep the de-registered vehicle under this rule has, with the permission of the Registrar, immobilised the vehicle by —
- (a) removing the engine of the vehicle;
- (b) bolting the chassis of the vehicle to the ground; or
- (c) such other method as the Registrar may permit, subject to such terms and conditions as the Registrar thinks fit to impose.
- (8) Subject to paragraph (9), any approval granted to any person under this rule for the keeping of a de-registered vehicle shall not be transferable and shall be revoked upon the occurrence of the following event:
- (a) where the person is an individual, the demise of that person; or
- (b) where the person is a company or corporation, the dissolution of that company or corporation.
- (9) The Registrar may, upon an application by the parent, sibling, spouse or child, or the executor or administrator of the estate, of any deceased person referred to in paragraph (8)(a) and subject to such

terms and conditions as the Registrar thinks fit to impose, grant approval to such parent, sibling, spouse, child, executor or administrator to keep the relevant de-registered vehicle in the private area or compound approved by the Registrar.

(10) An application under paragraph (1), (3), (5)(b) or (9) shall —

(a) be made in such form or manner, and be supported by such particulars or documents, as the Registrar may require; and

(b) be accompanied by the following fees:

(i) in the case of an application for approval under paragraph (1) or (9), or for extension of approval under paragraph (3) —

(A) where the approval or extension of approval is for a period that does not exceed one year, a sum of \$267.50 (inclusive of GST); or

(B) where the approval or extension of approval is for a period that exceeds one year but does not exceed 3 years, a sum of \$642 (inclusive of GST);

(ii) in the case of an application for special approval under paragraph (5)(b), a sum of \$133.75 (inclusive of GST).

[S 696/2017 wef 20/12/2017]

(11) The Registrar may revoke any approval granted by him under paragraph (2), (3), (5)(b) or (9) if the person to whom the approval was granted —

(a) has breached any term or condition subject to which the approval was granted;

(b) has been found to have furnished any false or misleading particulars or document when applying for the approval; or

(c) has contravened any provision of the Act.

(12) Where any approval granted to a person by the Registrar under paragraph (2), (3), (5)(b) or (9) has expired or been revoked by the Registrar, that person or any person who is in possession of the

relevant de-registered vehicle shall, upon the expiry or the revocation of the approval and within such period as the Registrar may require or allow —

- (a) scrap or export the de-registered vehicle; and
- (b) produce proof of such scrapping or export to the satisfaction of the Registrar.

(13) Where any person to whom any approval has been granted under paragraph (2), (3), (5)(b) or (9) has died or, in the case of a company or corporation, has been dissolved, the personal representative of the estate of the deceased individual or the liquidator or official receiver of the dissolved company or corporation (as the case may be) shall, upon the expiry or the revocation of the approval and within such period as the Registrar may require or allow —

- (a) scrap or export the relevant de-registered vehicle; and
- (b) produce proof of such scrapping or export to the satisfaction of the Registrar.

(14) The Registrar may, in his discretion and subject to such terms and conditions as he thinks fit to impose, waive in whole or in part any fee payable under paragraph (10)(b).

(15) The Registrar may, in his discretion, require the inspection, by any person authorised by him, of —

- (a) any de-registered vehicle in respect of which approval under this rule is being applied for or has been granted;
- (b) the private area or compound in which the de-registered vehicle is being kept or proposed to be kept; or
- (c) the sealed identification mark affixed on the vehicle.

(16) Any person who furnishes any particulars to the Registrar in his application under this rule which to his knowledge is false or in any material respect misleading shall be guilty of an offence.

Keeping of unregistered vehicles in approved private areas and compounds

34C.—(1) Any person who wishes to keep an unregistered vehicle in any private area or compound may apply to the Registrar for approval to do so.

(2) The Registrar may, in his discretion and subject to such terms and conditions as he thinks fit to impose, grant his approval to the applicant to keep the unregistered vehicle for a period not exceeding 3 years in the private area or compound approved by the Registrar.

(3) The Registrar may, from time to time upon an application being made to him and subject to such terms and conditions as he thinks fit to impose, extend the period for which any approval granted by him under paragraph (2) shall be valid, except that each such extension shall be for a period not exceeding 3 years.

(4) Unless the Registrar allows otherwise, no application under paragraph (3) in respect of any unregistered vehicle shall be accepted if it is received by the Registrar less than 7 days before the period to be extended expires.

(5) Any person who has been granted approval under this rule to keep an unregistered vehicle in a private area or compound approved by the Registrar —

(a) shall at all times keep the unregistered vehicle within that private area or compound; and

(b) shall not remove the unregistered vehicle to any other place unless —

(i) he has applied for and obtained the special approval of the Registrar to so remove the unregistered vehicle; and

(ii) the place to which he intends to remove the unregistered vehicle is approved by the Registrar.

(6) Subject to paragraph (7), where the identification mark to be affixed to an unregistered vehicle under rule 17(2)(h) is not affixed to the vehicle in the required manner or, being so affixed, is removed, defaced, altered, obscured or tampered with —

(a) the person to whom approval for the keeping of the vehicle has been granted under this rule; and

(b) any other person in possession of the vehicle,

shall both be guilty of an offence.

(7) The Registrar may waive the requirements under rule 17(2)(h) if the person granted approval to keep the unregistered vehicle under this rule has, with the permission of the Registrar, immobilised the vehicle by —

- (a) removing the engine of the vehicle;
- (b) bolting the chassis of the vehicle to the ground; or
- (c) such other method as the Registrar may permit, subject to such terms and conditions as the Registrar thinks fit to impose.

(8) Subject to paragraph (9), any approval granted to any person under this rule for the keeping of an unregistered vehicle shall not be transferable and shall be revoked —

- (a) where the person is an individual, upon the demise of that person; or
- (b) where the person is a company or corporation, upon the dissolution of that company or corporation.

(9) The Registrar may, upon an application by the parent, sibling, spouse or child, or the executor or administrator of the estate, of any deceased person referred to in paragraph (8)(a) and subject to such terms and conditions as the Registrar thinks fit to impose, grant approval to such parent, sibling, spouse, child, executor or administrator to continue to keep the relevant unregistered vehicle in —

- (a) the private area or compound at which the deceased person had, with the approval of the Registrar under paragraph (2), been keeping that unregistered vehicle before his death; or
- (b) any other place approved by the Registrar.

(10) An application under paragraph (1), (3), (5)(b) or (9) shall —

(a) be made in such form or manner, and be supported by such particulars or documents, as the Registrar may require; and

(b) be accompanied by the following fee:

(i) in the case of an application for approval under paragraph (1), (3) or (9) —

(A) \$267.50 (inclusive of GST) for an approval that is valid for a period not exceeding one year; or

(B) \$642 (inclusive of GST) for an approval that is valid for a period exceeding one year but not exceeding 3 years; and

[S 696/2017 wef 20/12/2017]

(ii) in the case of an application under paragraph (5)(b), \$133.75 (inclusive of GST).

[S 696/2017 wef 20/12/2017]

(11) The Registrar may revoke any approval granted by him under paragraph (2), (3), (5)(b) or (9) if the person to whom the approval was granted —

(a) has breached any term or condition subject to which the approval was granted;

(b) has been found to have furnished any false or misleading particulars or document when applying for the approval; or

(c) has contravened any provision of the Act.

(12) Where any approval granted to a person by the Registrar under paragraph (2), (3), (5)(b) or (9) has expired or been revoked by the Registrar, that person or any person who is in possession of the relevant unregistered vehicle shall, within such period as the Registrar may require or allow after the expiry or the revocation of the approval —

(a) scrap or export the unregistered vehicle; and

(b) produce proof of such scrapping or export to the satisfaction of the Registrar.

(13) Where any person to whom any approval has been granted under paragraph (2), (3), (5)(b) or (9) has died or, in the case of a company or corporation, has been dissolved, the personal representative of the estate of the deceased individual or the liquidator or official receiver of the dissolved company or corporation (as the case may be) shall, within such period as the Registrar may require or allow after the expiry or the revocation of the approval —

- (a) scrap or export the relevant unregistered vehicle; and
- (b) produce proof of such scrapping or export to the satisfaction of the Registrar.

(14) The Registrar may, in his discretion and subject to such terms and conditions as he thinks fit to impose, waive in whole or in part any fee payable under paragraph (10)(b).

(15) The Registrar may, in his discretion, require the inspection, by any person authorised by him, of —

- (a) any unregistered vehicle in respect of which approval under this rule is being applied for or has been granted;
- (b) the private area or compound in which the unregistered vehicle is being kept or proposed to be kept; or
- (c) the sealed identification mark affixed on the vehicle.

(16) Any person who furnishes any particulars to the Registrar in his application under this rule which to his knowledge is false or in any material respect misleading shall be guilty of an offence.

Keeping of de-registered original vehicle prior to destruction or export

34D.—(1) Rules 34A and 34B shall not apply to an original vehicle which has been de-registered pursuant to rule 3F(2)(b).

(2) Where section 27(1)(d)(i) or (iii) of the Act applies, the owner or person in possession of the de-registered original vehicle shall cause the vehicle to be destroyed or permanently removed from Singapore within one month after the date of cancellation of the

registration of the vehicle, or such longer period as the Registrar may approve in any particular case.

(3) Until the de-registered original vehicle has been destroyed or permanently removed from Singapore, the vehicle shall be kept in such private area or compound or designated area, as the Registrar may direct.

PART VI LICENCES

Application for licence

35.—(1) An application for a licence for a motor vehicle or trailer which has not previously been licensed under these Rules shall be —

- (a) made in such form as the Registrar may require; and
- (b) made by the person who applies under rule 3 to be registered as the owner of such vehicle.

(2) An application for a licence for a motor vehicle or trailer which has previously been licensed shall be in such form as the Registrar may require.

(3) [*Deleted by S 330/2009*]

Period of motor vehicle licence

36.—(1) Upon receipt of an application for a licence under rule 35, the Registrar may issue a licence for such motor vehicle as is referred to in the application.

(2) Every licence issued under this rule shall, as from the date specified in the licence, be valid for a period of 6 or 12 months or for such shorter period as the Registrar may think fit.

(3) Upon receipt of an application for a licence for —

- (a) any special motor vehicle or special type of motor vehicle, the use of which has for the time being been authorised pursuant to section 5(2) of the Act; or

- (b) any motor vehicle approved by the Registrar as a normal vintage vehicle,

the Registrar may issue a licence for such motor vehicle for a period of not less than one day.

(4) Subject to paragraphs (4AA), (4AB) and (4C) to (7) and rules 38 and 38C, the fee payable for a licence under this rule shall be the appropriate fee specified in —

- (a) the Second Schedule, if the licence commences before 1st September 1998;
- (b) the Sixth Schedule, if the licence commences on any date between 1st September 1998 and 31st August 2002 (both dates inclusive);
- (c) the Ninth Schedule, if the licence commences on any date between 1st September 2002 and 31st August 2007 (both dates inclusive);
- (d) the Eleventh Schedule, if the licence commences on any date between 1st September 2007 and 30th June 2008 (both dates inclusive); or
- (e) the Twelfth Schedule, if the licence commences on or after 1st July 2008.

[S 366/2015 wef 14/06/2015]

[S 327/2017 wef 25/06/2017]

(4A) Notwithstanding paragraph (4), the fee payable for a licence under this rule —

- (a) for a taxi, or a bus, goods vehicle or goods-cum-passengers vehicle using diesel or petroleum as fuel; and
- (b) that commences on any date between 1st July 2009 and 30th June 2010 (both dates inclusive) or between 1st July 2013 and 30th June 2014 (both dates inclusive),

shall be the appropriate fee specified in the Fourteenth Schedule.

(4AA) Despite paragraphs (4) and (4A), and subject to paragraph (4D), where a licence for a motor car, motor cycle, scooter, taxi, bus, goods vehicle, prime mover or goods-cum-

passengers vehicle using petroleum or using both petroleum and either natural gas or electricity as its source or sources of power begins on any date during the period from 1 August 2015 to 31 July 2016 (both dates inclusive), the fee payable for the licence is the appropriate fee specified in the Fifteenth Schedule.

[S 366/2015 wef 14/06/2015]

(4AB) Despite paragraphs (4) and (4A), and subject to paragraph (4F), where —

(a) a licence is for a vehicle that uses diesel, or both diesel and either natural gas or electricity, as its source or sources of power, and is —

(i) a bus (other than an omnibus that is kept or used to provide bus services under a public bus services contract); or

(ii) a goods vehicle, prime mover or goods-cum-passengers vehicle; and

(b) the licence begins on any date during the period from 1 August 2017 to 31 July 2020 (both dates inclusive),

then the fee payable for the licence is the appropriate fee specified in the Seventeenth Schedule.

[S 327/2017 wef 25/06/2017]

(4B) Where a licence referred to in paragraph (4A) commences on any date before 1st July 2013 but the period for which the licence is taken out falls partly in the period between 1st July 2013 and 30th June 2014 (both dates inclusive), the fee payable for the licence shall be the sum of the following:

(a) the appropriate fee specified in the Twelfth Schedule calculated on a pro-rata basis for the period of the licence ending on 30th June 2013; and

(b) the appropriate fee specified in the Fourteenth Schedule calculated on a pro-rata basis for the remaining period of the licence.

(4C) Where a licence referred to in paragraph (4AA) begins before 1 August 2015 and remains valid at any time during the period from

1 August 2015 to 31 July 2016 (both dates inclusive), the fee payable for the licence is the sum of the following:

- (a) the appropriate fee specified in the Twelfth Schedule calculated proportionately for the period of the licence ending with 31 July 2015;
- (b) the appropriate fee specified in the Fifteenth Schedule calculated proportionately for the period of the licence remaining after 31 July 2015.

[S 366/2015 wef 14/06/2015]

(4D) Where a licence referred to in paragraph (4AA) begins on any date during the period from 1 August 2015 to 31 July 2016 (both dates inclusive) and remains valid after 31 July 2016, the fee payable for the licence is the sum of the following:

- (a) the appropriate fee specified in the Fifteenth Schedule calculated proportionately for the period of the licence ending with 31 July 2016;
- (b) the appropriate fee specified in the Twelfth Schedule calculated proportionately for the period of the licence remaining after 31 July 2016.

[S 366/2015 wef 14/06/2015]

(4E) Where a licence mentioned in paragraph (4AB) begins before 1 August 2017 and remains valid at any time during the period from 1 August 2017 to 31 July 2020 (both dates inclusive), the fee payable for the licence is the sum of the following:

- (a) the appropriate fee specified in the Twelfth Schedule calculated proportionately for the period of the licence ending with 31 July 2017;
- (b) the appropriate fee specified in the Seventeenth Schedule calculated proportionately for the period of the licence remaining after 31 July 2017.

[S 327/2017 wef 25/06/2017]

(4F) Where a licence mentioned in paragraph (4AB) begins on any date during the period from 1 August 2017 to 31 July 2020 (both dates

inclusive) and remains valid after 31 July 2020, the fee payable for the licence is the sum of the following:

- (a) the appropriate fee specified in the Seventeenth Schedule calculated proportionately for the period of the licence ending with 31 July 2020;
- (b) the appropriate fee specified in the Twelfth Schedule calculated proportionately for the period of the licence remaining after 31 July 2020.

[S 327/2017 wef 25/06/2017]

(5) Where the amount of the fee payable under paragraph (4)(b) for a licence for a motor vehicle exceeds the amount of the fee which would have been payable under paragraph (4)(a) for a licence for that same vehicle, then, subject to paragraph (7) and rule 38 —

- (a) the fee payable for a licence for such motor vehicle, which commences on any date from 1st September 1998 to 31st August 1999, shall be computed in accordance with the formula —

$$\text{\$X} + \frac{(\text{Y} - \text{X})}{3};$$

- (b) the fee payable for a licence for such motor vehicle, which commences on any date from 1st September 1999 to 31st August 2000, shall be computed in accordance with the formula —

$$\text{\$X} + \frac{2(\text{Y} - \text{X})}{3}$$

where, for the purposes of sub-paragraphs (a) and (b) —

X is the fee which would have been payable under paragraph (4)(a) for the licence had such licence commenced before 1st September 1998; and

Y is the fee payable under paragraph (4)(b) for the licence if such licence commences on or after 1st September 1998; and

(c) the fee payable for a licence for such motor vehicle, which commences on or after 1st September 2000, shall be the appropriate fee payable under paragraph (4)(b).

(6) Where the period for which a licence is taken out falls within more than one of the periods referred to in paragraph (5)(a), (b) or (c), the fee payable for the licence under this rule shall be computed on a pro-rata basis.

(7) Where the Registrar has granted permission under the Road Traffic (Public Service Vehicles) Rules (R 14) for any bus (other than an omnibus or a school bus) to convey school children for any period, the Registrar may, subject to such conditions as he thinks fit to impose, allow a rebate of 50% of the fee which has been paid under this rule for the licence for the bus during the period for which the bus was used to convey school children.

(8) The fee payable in respect of a licence for a special motor vehicle or special type of motor vehicle under paragraph (3) shall be of the following amount for every day on which such licence is used:

- (a) one-thirtieth of the appropriate fee in the Second Schedule, if the licence commences before 1st September 1998;
- (b) one-thirtieth of the appropriate fee in the Sixth Schedule, if the licence commences on any date between 1st September 1998 and 31st August 2002 (both dates inclusive);
- (c) one-thirtieth of the appropriate fee in the Ninth Schedule, if the licence commences on any date between 1st September 2002 and 31st August 2007 (both dates inclusive); or
- (d) computed in accordance with the following formula:

$$\text{\$} \left(\frac{1}{Y} \times \frac{A}{6} \right)$$

where Y is the number of days in the month; and

A is the appropriate fee —

- (i) in the Eleventh Schedule, if the licence begins on any date during the period from 1 September 2007 to 30 June 2008 (both dates inclusive);

- (ii) in the Twelfth Schedule, if the licence begins on or after 1 July 2008, except as stated in paragraph (iii) or (iv);
- (iii) in the Fifteenth Schedule, if the special motor vehicle or special type of motor vehicle uses petroleum or uses both petroleum and either natural gas or electricity as its source or sources of power and the licence begins on any date during the period from 1 August 2015 to 31 July 2016 (both dates inclusive); or
- (iv) in the Seventeenth Schedule, if the special motor vehicle or special type of motor vehicle uses diesel or both diesel and either natural gas or electricity as its source or sources of power and the licence begins on any date during the period from 1 August 2017 to 31 July 2020 (both dates inclusive).

[S 327/2017 wef 25/06/2017]

[S 366/2015 wef 14/06/2015]

(9) If, in the opinion of the Registrar, any motor vehicle registered under these Rules shall by reason of its condition, lack of maintenance, accident or any defect become unsafe or unfit for service, the Registrar may cancel the registration of the vehicle and may order the vehicle to be broken up.

(10) This rule shall not apply to a PU-registered vehicle.

Licence fee for electric car

36A. Subject to rule 38, the fee payable for a licence for an electric car shall be the appropriate fee specified in —

- (a) the Sixth Schedule, if the licence commences on any date between 1st September 1998 and 31st August 2002 (both dates inclusive);

- (b) the Ninth Schedule, if the licence commences on any date between 1st September 2002 and 31st August 2007 (both dates inclusive);
- (c) the Eleventh Schedule, if the licence commences on any date between 1st September 2007 and 30th June 2008 (both dates inclusive); or
- (d) the Twelfth Schedule, if the licence commences on or after 1st July 2008.

Licence fee for petrol-electric car and diesel-electric car

36B.—(1) Subject to rule 38, the fee payable for a licence for a petrol-electric car shall be the higher of the appropriate fee, based on the cylinder capacity or maximum power rating of the petrol-electric car, specified in —

- (a) the Sixth Schedule, if the licence commences on any date between 1st September 1998 and 31st August 2002 (both dates inclusive);
- (b) the Ninth Schedule, if the licence commences on any date between 1st September 2002 and 31st August 2007 (both dates inclusive);
- (c) the Eleventh Schedule, if the licence commences on any date between 1st September 2007 and 30th June 2008 (both dates inclusive); or
- (d) the Twelfth Schedule, if the licence commences on or after 1st July 2008, except as stated in paragraphs (1A), (1B) and (1C).

[S 366/2015 wef 14/06/2015]

(1A) Where a licence for a petrol-electric car begins on any date during the period from 1 August 2015 to 31 July 2016 (both dates inclusive), the fee payable is the appropriate fee specified in the Fifteenth Schedule.

[S 366/2015 wef 14/06/2015]

(1B) Where a licence for a petrol-electric car begins before 1 August 2015 and remains valid at any time during the period

from 1 August 2015 to 31 July 2016 (both dates inclusive), the fee payable for the licence is the sum of the following:

- (a) the appropriate fee specified in the Twelfth Schedule calculated proportionately for the period of the licence ending with 31 July 2015;
- (b) the appropriate fee specified in the Fifteenth Schedule calculated proportionately for the period of the licence remaining after 31 July 2015.

[S 366/2015 wef 14/06/2015]

(1C) Where a licence for a petrol-electric car begins on any date during the period from 1 August 2015 to 31 July 2016 (both dates inclusive) and remains valid after 31 July 2016, the fee payable for the licence is the sum of the following:

- (a) the appropriate fee specified in the Fifteenth Schedule calculated proportionately for the period of the licence ending with 31 July 2016;
- (b) the appropriate fee specified in the Twelfth Schedule calculated proportionately for the period of the licence remaining after 31 July 2016.

[S 366/2015 wef 14/06/2015]

(2) Subject to rule 38, the fee payable for a licence for a diesel-electric car shall be based on the cylinder capacity specified for motor cars in the Twelfth Schedule, if the licence commences on or after 1st July 2008.

Licence fee for buses, goods vehicles and goods-cum-passengers vehicles which are CNG vehicles, petrol-CNG vehicles, diesel-CNG vehicles, electric vehicles, or petrol-electric vehicles or diesel-electric vehicles

36C.—(1) The fee payable for a licence that commences on or after 1st January 2006 for a bus, goods vehicle or goods-cum-passengers vehicle which is a CNG vehicle, a petrol-CNG vehicle, a diesel-CNG vehicle, an electric vehicle, a petrol-electric vehicle or a diesel-electric vehicle shall be the appropriate fee specified in —

- (a) the Tenth Schedule, if the licence commences on any date between 1st January 2006 and 30th June 2008 (both dates inclusive); and
- (b) the Twelfth Schedule, if the licence commences on or after 1st July 2008, except as stated in paragraphs (2A), (2B), (4), (5), (6) and (7) and rule 38C.

[S 366/2015 wef 14/06/2015]

[S 327/2017 wef 25/06/2017]

(2) Notwithstanding paragraph (1), the appropriate fee specified in the Fourteenth Schedule shall be payable for a licence referred to in that paragraph that commences on any date —

- (a) between 1st July 2009 and 30th June 2010 (both dates inclusive); or
- (b) between 1st July 2013 and 30th June 2014 (both dates inclusive).

(2A) Despite paragraph (1), and subject to paragraph (5), where a licence for a petrol-CNG vehicle or petrol-electric vehicle begins on any date during the period from 1 August 2015 to 31 July 2016 (both dates inclusive), the fee payable for the licence is the appropriate fee specified in the Fifteenth Schedule.

[S 366/2015 wef 14/06/2015]

(2B) Despite paragraph (1), and subject to paragraph (7), where —

- (a) a licence is for a diesel-CNG vehicle or a diesel-electric vehicle that is a bus (other than an omnibus that is kept or used to provide bus services under a public bus services contract), goods vehicle, prime mover or goods-cum-passengers vehicle; and
- (b) the licence begins on any date during the period from 1 August 2017 to 31 July 2020 (both dates inclusive),

then the fee payable for the licence is the appropriate fee specified in the Seventeenth Schedule.

[S 327/2017 wef 25/06/2017]

(3) Where a licence referred to in paragraph (1) commences on any date before 1st July 2013 but the period for which the licence is taken

out falls partly in the period between 1st July 2013 and 30th June 2014 (both dates inclusive), the fee payable for the licence shall be the sum of the following:

- (a) the appropriate fee specified in the Twelfth Schedule calculated on a pro-rata basis for the period of the licence ending on 30th June 2013; and
- (b) the appropriate fee specified in the Fourteenth Schedule calculated on a pro-rata basis for the remaining period of the licence.

(4) Despite paragraph (1), where a licence for a petrol-CNG vehicle or petrol-electric vehicle begins before 1 August 2015 and remains valid at any time during the period from 1 August 2015 to 31 July 2016 (both dates inclusive), the fee payable for the licence is the sum of the following:

- (a) the appropriate fee specified in the Twelfth Schedule calculated proportionately for the period of the licence ending with 31 July 2015;
- (b) the appropriate fee specified in the Fifteenth Schedule calculated proportionately for the period of the licence remaining after 31 July 2015.

[S 366/2015 wef 14/06/2015]

(5) Despite paragraph (1), where a licence for a petrol-CNG vehicle or petrol-electric vehicle begins on any date during the period from 1 August 2015 to 31 July 2016 (both dates inclusive) and remains valid after 31 July 2016, the fee payable for the licence is the sum of the following:

- (a) the appropriate fee specified in the Fifteenth Schedule calculated proportionately for the period of the licence ending with 31 July 2016;
- (b) the appropriate fee specified in the Twelfth Schedule calculated proportionately for the period of the licence remaining after 31 July 2016.

[S 366/2015 wef 14/06/2015]

(6) Despite paragraph (1), where a licence for a vehicle mentioned in paragraph (2B)(a) begins before 1 August 2017 and remains valid at any time during the period from 1 August 2017 to 31 July 2020 (both dates inclusive), the fee payable for the licence is the sum of the following:

- (a) the appropriate fee specified in the Twelfth Schedule calculated proportionately for the period of the licence ending with 31 July 2017;
- (b) the appropriate fee specified in the Seventeenth Schedule calculated proportionately for the period of the licence remaining after 31 July 2017.

[S 327/2017 wef 25/06/2017]

(7) Despite paragraph (1), where a licence for a vehicle mentioned in paragraph (2B)(a) begins on any date during the period from 1 August 2017 to 31 July 2020 (both dates inclusive) and remains valid after 31 July 2020, the fee payable for the licence is the sum of the following:

- (a) the appropriate fee specified in the Seventeenth Schedule calculated proportionately for the period of the licence ending with 31 July 2020;
- (b) the appropriate fee specified in the Twelfth Schedule calculated proportionately for the period of the licence remaining after 31 July 2020.

[S 327/2017 wef 25/06/2017]

Licence fee for electric motor cycles and electric scooters

36D. The fee payable for a licence commencing on or after 13th April 2009 for an electric motor cycle or electric scooter, having a power rating not exceeding 10 kW, shall be the appropriate fee specified in the Twelfth Schedule.

Licence fee for CNG car, petrol-CNG car and diesel-CNG car

36E.—(1) Subject to rule 38, the fee payable for a licence for a CNG car, a petrol-CNG car or a diesel-CNG car shall be based on the cylinder capacity specified for motor cars in —

- (a) the Sixth Schedule, if the licence commences on any date between 1st September 1998 and 31st August 2002 (both dates inclusive);
- (b) the Ninth Schedule, if the licence commences on any date between 1st September 2002 and 31st August 2007 (both dates inclusive);
- (c) the Eleventh Schedule, if the licence commences on any date between 1st September 2007 and 30th June 2008 (both dates inclusive); or
- (d) the Twelfth Schedule, if the licence commences on or after 1st July 2008, except as stated in paragraphs (2), (3) and (4).

[S 366/2015 wef 14/06/2015]

[S 366/2015 wef 14/06/2015]

(2) Despite paragraph (1), and subject to paragraph (4), where a licence for a petrol-CNG car begins on any date during the period from 1 August 2015 to 31 July 2016 (both dates inclusive), the fee payable for the licence is the appropriate fee specified in the Fifteenth Schedule.

[S 366/2015 wef 14/06/2015]

(3) Despite paragraph (1), where a licence for a petrol CNG car begins before 1 August 2015 and remains valid at any time during the period from 1 August 2015 to 31 July 2016 (both dates inclusive), the fee payable for the licence is the sum of the following:

- (a) the appropriate fee specified in the Twelfth Schedule calculated proportionately for the period of the licence ending with 31 July 2015;
- (b) the appropriate fee specified in the Fifteenth Schedule calculated proportionately for the period of the licence remaining after 31 July 2015.

[S 366/2015 wef 14/06/2015]

(4) Despite paragraph (1), where a licence for a petrol CNG car begins on any date during the period from 1 August 2015 to 31 July 2016 (both dates inclusive) and remains valid after 31 July 2016, the fee payable for the licence is the sum of the following:

- (a) the appropriate fee specified in the Fifteenth Schedule calculated proportionately for the period of the licence ending with 31 July 2016;
- (b) the appropriate fee specified in the Twelfth Schedule calculated proportionately for the period of the licence remaining after 31 July 2016.

[S 366/2015 wef 14/06/2015]

Additional licence fee

37.—(1) Subject to paragraph (4), in addition to the fee payable under rule 36(4), (4A), (4AA), (4AB), (4B), (4C), (4D), (4E), (4F), (5), (6), (7) or (8), 36A, 36B, 36C, 36D, 36E or 38(2) or (3), a fee calculated in accordance with this rule shall be payable for a licence for any vehicle which is more than 10 years old.

[S 810/2014 wef 12/12/2014]

[S 366/2015 wef 14/06/2015]

[S 327/2017 wef 25/06/2017]

(2) Where a vehicle is on 1st May 1990 more than 10 years old, the additional fee for a licence for such vehicle shall be an amount equal to 50% of the base fee for the licence.

(3) Where a vehicle becomes more than 10 years old only after 1st May 1990, the additional fee for a licence for such vehicle shall be an amount equal to —

- (a) 10% of the base fee for the licence if the licence is taken out for any period after the expiration of the last licence for the vehicle but before the vehicle exceeds 11 years old;
- (b) 20% of the base fee for the licence if the licence is taken out for any period when the vehicle exceeds 11 years old but before it exceeds 12 years old;
- (c) 30% of the base fee for the licence if the licence is taken out for any period when the vehicle exceeds 12 years old but before it exceeds 13 years old;
- (d) 40% of the base fee for the licence if the licence is taken out for any period when the vehicle exceeds 13 years old but before it exceeds 14 years old; or

(e) 50% of the base fee for the licence if the licence is taken out for any period when the vehicle exceeds 14 years old.

(4) Nothing in this rule shall apply to any motor vehicle where its licence had expired on or before 31st March 1990 and in respect of which another licence was issued to the owner of the vehicle at any time prior to 1st May 1990.

(5) For the purposes of this rule —

(a) any reference to the base fee for a licence for any vehicle shall be a reference to the fee payable under rule 36(4), (4A), (4AB), (4B), (4E), (4F) or (8), 36A, 36B, 36C, 36D or 36E for such licence at the time the licence is issued; and

[S 810/2014 wef 12/12/2014]

[S 327/2017 wef 25/06/2017]

(b) where the period for which a licence is taken out falls within more than one sub-paragraph in paragraph (3), the additional licence fee payable under this rule shall be computed on a pro-rata basis.

(6) Subject to rule 38B(4), this rule shall not apply to a PU-registered vehicle.

Licence for off-peak car and supplementary licence

38.—(1) Every licence for an off-peak car shall be subject to the restriction that the off-peak car shall not be driven on any road during the days and times specified in the Fifth Schedule unless there is in force a supplementary licence issued under Part IX for that vehicle.

(2) Subject to paragraphs (4) and (4A), the fee payable for a licence for an off-peak car shall be —

(a) in the case of an off-peak car in respect of which a category (f) certificate of entitlement has been issued, 30% of the base licence fee, provided that the rebate of 70% granted does not exceed \$1,500 but when the rebate granted exceeds \$1,500, then the fee payable for the licence shall be the base licence fee minus \$1,500;

- (b) in the case of a private motor car which has been re-registered as an off-peak car under rule 33 before 1st September 1994, 5% of the base licence fee, provided that the rebate of 95% granted does not exceed \$1,500 but where the rebate granted exceeds \$1,500, then the fee payable for the licence shall be the base licence fee minus \$1,500;
- (c) in the case of any vehicle not falling within the description of sub-paragraph (a) or (b) and which —
 - (i) before 25th January 2010 was registered as an off-peak car under rule 32 or re-registered as an off-peak car under rule 33; and
 - (ii) has not been re-registered as an off-peak car under rule 33E,

the fee payable for the licence shall be the base licence fee minus \$800 for 12 months; and

- (d) in the case of a vehicle which, on or after 25th January 2010, has been registered as an off-peak car under rule 32 or re-registered as an off-peak car under rule 33E, the fee payable for the licence shall be the base licence fee minus \$500 for 12 months.

[S 678/2014 wef 03/10/2014]

- (3) Any reference in paragraph (2)(a) and (b) to \$1,500 shall —
 - (a) from 1st September 1995 to 31st August 1996, be read as a reference to \$1,300;
 - (b) from 1st September 1996 to 31st August 1997, be read as a reference to \$1,100; and
 - (c) from 1st September 1997 onwards, be read as a reference to \$800.
- (4) Where the amount referred to in paragraph (2)(a), (b) or (c) is less than \$50, the minimum amount of the licence fee payable is —
 - (a) in the case of an off-peak car using petroleum or using both petroleum and either natural gas or electricity as its source or sources of power and with a licence beginning on any

date during the period from 1 August 2015 to 31 July 2016 (both dates inclusive), \$40; and

(b) in any other case, \$50.

[S 366/2015 wef 14/06/2015]

(4A) Where the amount referred to in paragraph (2)(d) is less than \$70, the minimum amount of the licence fee payable is —

(a) in the case of an off-peak car using petroleum or using both petroleum and either natural gas or electricity as its source or sources of power and with a licence beginning on any date during the period from 1 August 2015 to 31 July 2016 (both dates inclusive), \$56; and

(b) in any other case, \$70.

[S 366/2015 wef 14/06/2015]

(5) For the purposes of this rule, “base licence fee” means the fee payable under rule 36(4), at the time the licence is issued, for a licence for a private motor car of the same cylinder capacity as the off-peak car.

Licence for classic vehicle and supplementary licence

38A.—(1) Every licence for a classic vehicle shall be subject to the restriction that the classic vehicle shall not be driven on any road at any time unless there is in force a supplementary licence issued under Part IX for that vehicle.

(2) Subject to paragraphs (2A), (2B) and (2C), the fee payable for a licence for a classic vehicle shall be \$280 for 12 months.

[S 366/2015 wef 14/06/2015]

(2A) Subject to paragraph (2C), where a licence for a classic car, classic motor cycle or classic scooter using petroleum or using both petroleum and either natural gas or electricity as its source or sources of power begins on any date during the period from 1 August 2015 to 31 July 2016 (both dates inclusive), the fee payable for the licence is —

(a) \$224 for the classic car; and

(b) \$112 for the classic motor cycle or classic scooter.

[S 366/2015 wef 14/06/2015]

(2B) Where a licence for a classic vehicle using petroleum or using both petroleum and either natural gas or electricity as its source or sources of power begins before 1 August 2015 and remains valid at any time during the period from 1 August 2015 to 31 July 2016 (both dates inclusive), the fee payable for the licence is the sum of the following:

- (a) the fee specified in paragraph (2) calculated proportionately for the period of the licence ending with 31 July 2015;
- (b) the appropriate fee specified in paragraph (2A) calculated proportionately for the period of the licence remaining after 31 July 2015.

[S 366/2015 wef 14/06/2015]

(2C) Where a licence for a classic vehicle using petroleum or using both petroleum and either natural gas or electricity as its source or sources of power begins on any date during the period from 1 August 2015 to 31 July 2016 (both dates inclusive) and remains valid at any time after 31 July 2016, the fee payable for the licence is the sum of the following:

- (a) the appropriate fee specified in paragraph (2A) calculated proportionately for the period of the licence ending with 31 July 2016;
- (b) the fee specified in paragraph (2) calculated proportionately for the period of the licence remaining after 31 July 2016.

[S 366/2015 wef 14/06/2015]

(3) Notwithstanding rule 36(2), every licence for a classic vehicle shall be valid for a period of one calendar year or for such shorter period as the Registrar may think fit.

Licence for PU-registered vehicles

38B.—(1) The Registrar may, in his discretion, upon application in an approved form by the owner of a PU-registered vehicle, issue or renew a PU-registered vehicle licence.

(2) The issuance of a PU-registered vehicle licence shall be subject to —

(a) the condition that the motor vehicle shall be kept and used only on Pulau Ubin; and

(b) such other conditions as the Registrar may impose.

(3) Subject to paragraphs (3A) to (4) and rule 38C, the fee payable for a licence issued under this rule shall be the appropriate fee specified in the Seventh Schedule.

[S 366/2015 wef 14/06/2015]

[S 327/2017 wef 25/06/2017]

(3A) Subject to paragraph (3C), where a licence for a PU-registered vehicle using petroleum or using both petroleum and either natural gas or electricity as its source or sources of power begins on any date during the period from 1 August 2015 to 31 July 2016 (both dates inclusive), the fee payable for the licence is the appropriate fee specified in the Sixteenth Schedule.

[S 366/2015 wef 14/06/2015]

(3B) Where a licence for a PU-registered vehicle using petroleum or using both petroleum and either natural gas or electricity as its source or sources of power begins before 1 August 2015 and remains valid at any time during the period from 1 August 2015 to 31 July 2016 (both dates inclusive), the fee payable for the licence is the sum of the following:

(a) the appropriate fee specified in the Seventh Schedule calculated proportionately for the period of the licence ending with 31 July 2015;

(b) the appropriate fee specified in the Sixteenth Schedule calculated proportionately for the period of the licence remaining after 31 July 2015.

[S 366/2015 wef 14/06/2015]

(3C) Where a licence for a PU-registered vehicle using petroleum or using both petroleum and either natural gas or electricity as its source or sources of power begins on any date during the period from 1 August 2015 to 31 July 2016 (both dates inclusive) and remains valid at any time after 31 July 2016, the fee payable for the licence is the sum of the following:

- (a) the appropriate fee specified in the Sixteenth Schedule calculated proportionately for the period of the licence ending with 31 July 2016;
- (b) the appropriate fee specified in the Seventh Schedule calculated proportionately for the period of the licence remaining after 31 July 2016.

[S 366/2015 wef 14/06/2015]

(3D) Subject to paragraph (3F), where —

- (a) a licence is for a PU-registered vehicle that —
 - (i) is a bus, goods vehicle, prime mover or goods-cum-passengers vehicle; and
 - (ii) uses diesel, or both diesel and either natural gas or electricity, as its source or sources of power; and
- (b) the licence begins on any date during the period from 1 August 2017 to 31 July 2020 (both dates inclusive),

then, the fee payable for the licence is the appropriate fee specified in the Eighteenth Schedule.

[S 327/2017 wef 25/06/2017]

(3E) Where a licence for a PU-registered vehicle mentioned in paragraph (3D)(a) begins before 1 August 2017 and remains valid at any time during the period from 1 August 2017 to 31 July 2020 (both dates inclusive), the fees payable for the licence is the sum of the following:

- (a) the appropriate fee specified in the Seventh Schedule calculated proportionately for the period of the licence ending with 31 July 2017;

- (b) the appropriate fee specified in the Eighteenth Schedule calculated proportionately for the period of the licence remaining after 31 July 2017.

[S 327/2017 wef 25/06/2017]

(3F) Where a licence for a PU-registered vehicle mentioned in paragraph (3D)(a) begins on any date during the period from 1 August 2017 to 31 July 2020 (both dates inclusive) and remains valid at any time after 31 July 2020, the fee payable for the licence is the sum of the following:

- (a) the appropriate fee specified in the Eighteenth Schedule calculated proportionately for the period of the licence ending with 31 July 2020;
- (b) the appropriate fee specified in the Seventh Schedule calculated proportionately for the period of the licence remaining after 31 July 2020.

[S 327/2017 wef 25/06/2017]

(4) Where a PU-registered vehicle is kept or used outside Pulau Ubin in breach of the condition imposed under paragraph (2) —

- (a) the appropriate fee specified in —
- (i) the Sixth Schedule, if the licence commences on any date between 1st September 1998 and 31st August 2002 (both dates inclusive);
- (ii) the Ninth Schedule, if the licence commences on any date between 1st September 2002 and 31st August 2007 (both dates inclusive);
- (iii) the Eleventh Schedule, if the licence commences on any date between 1st September 2007 and 30th June 2008 (both dates inclusive);
- (iv) the Twelfth Schedule, if the licence commences on or after 1st July 2008, except as stated in sub-paragraph (v) or (vi);

[S 366/2015 wef 14/06/2015]

[S 366/2015 wef 14/06/2015]

[S 327/2017 wef 25/06/2017]

- (v) the Fifteenth Schedule, if the PU registered vehicle uses petroleum or uses both petroleum and either natural gas or electricity as its source or sources of power and the licence begins on any date during the period from 1 August 2015 to 31 July 2016 (both dates inclusive); or

[S 366/2015 wef 14/06/2015]

[S 327/2017 wef 25/06/2017]

- (vi) the Seventeenth Schedule, if the PU-registered vehicle is one mentioned in paragraph (3D)(a) and the licence begins on any date during the period from 1 August 2017 to 31 July 2020 (both dates inclusive),

[S 327/2017 wef 25/06/2017]

shall apply to a licence issued for that vehicle under this rule; and

- (b) the additional licence fee payable under rule 37 shall apply to a licence issued under this rule as if —
 - (i) a reference to the base fee for a licence in that rule refers to the fee payable under sub-paragraph (a); and
 - (ii) a reference to a licence in that rule refers to a licence issued under this rule.

(5) Every licence issued under this rule shall be valid for a maximum period of one year commencing 1st February or for such shorter period as the Registrar may think fit.

(6) The Registrar may, in his discretion, revoke a PU-registered vehicle licence upon the breach of any condition referred to in paragraph (2).

Rebate for applicable vehicles with licences issued before 25 June 2017 and valid on or after 1 August 2017

38C.—(1) There is a rebate for every licence for an applicable vehicle that is —

- (a) issued by the Registrar before 25 June 2017; and

- (b) valid at any time during the period from 1 August 2017 to 31 July 2020 (both dates inclusive).
- (2) The amount of the rebate is the difference between —
- (a) the fee paid for the licence for the applicable vehicle under rule 36(4), 36C(1), 37(1) or 38B(3) as in force immediately before 25 June 2017; and
- (b) the fee that would have been payable for the licence of the applicable vehicle had the Road Traffic (Motor Vehicles, Registration and Licensing) (Amendment No. 3) Rules 2017 (G.N. No. S 327/2017) been in force when the licence was issued.
- (3) The rebate calculated according to paragraph (2) in relation to a licence for an applicable vehicle may only be set off —
- (a) against the fee when payable under these Rules for the issue of a licence for the same applicable vehicle to the same licence holder; or
- (b) where the registration of the applicable vehicle is transferred before the expiry of the licence, against the following fees in the following order:
- (i) the fees required under rule 25(2) for any transfer of the registration of the vehicle before the expiry of the licence;
- (ii) the fee when payable under these Rules for the issue of a licence for the same applicable vehicle to the transferee.
- (4) To avoid doubt, the rebate under this rule is in addition to any other rebates granted by the Registrar under these Rules.
- (5) In this rule, “applicable vehicle” means —
- (a) a vehicle that uses diesel, or both diesel and either natural gas or electricity, as its source or sources of power, and is —

- (i) a bus (other than an omnibus that is kept or used to provide bus services under a public bus services contract); or
- (ii) a goods vehicle, prime mover or goods-cum-passengers vehicle;
- (b) a diesel-CNG vehicle or diesel-electric vehicle that is a bus (other than an omnibus that is kept or used to provide bus services under a public bus services contract), goods vehicle, prime mover or goods-cum-passengers vehicle; or
- (c) a PU-registered vehicle that —
 - (i) is a bus, goods vehicle, prime mover or goods-cum-passengers vehicle; and
 - (ii) uses diesel, or both diesel and either natural gas or electricity, as its source or sources of power.

[S 327/2017 wef 25/06/2017]

Conditions for issue and renewal of licence

39.—(1) Except where the Registrar otherwise permits, a licence shall not be issued under section 13 of the Act in respect of —

- (a) a goods vehicle or an ambulance which is more than 20 years old;
- (b) a motor car registered in the name of a statutory board, company, firm, society, club or an association using a certificate of entitlement issued on or after 1st April 1998 which is more than 10 years old and which is used for instructional purposes for reward;
- (c) a vehicle which has at any time been issued with an excursion bus licence, a school bus licence, a private hire bus licence or a private bus licence under the Road Traffic (Public Service Vehicles) Rules (R 14) and which has been used for more than 20 years;
- (d) a vehicle which has at any time been issued with an omnibus licence under the Road Traffic (Public Service Vehicles) Rules and —

- (i) in a case where the omnibus licence is issued before 1st September 2003, is more than 15 years old on that date; or
 - (ii) in any other case, is more than 17 years old;
- (e) a vehicle which has at any time been issued with a taxi licence under the Road Traffic (Public Service Vehicles) Rules and —
 - (i) in a case where the taxi licence is issued before 1st September 2003, is more than 7 years old on that date; or
 - (ii) in any other case, is more than 8 years old;
- (f) [*Deleted by S 476/2006*]
- (g) [*Deleted by S 476/2006*]
- (h) a vehicle registered in the name of any of the following persons which is more than 10 years old and which, at the time of registration, was more than 3 years old:
 - (i) a diplomatic officer;
 - (ii) a consular officer;
 - (iii) a representative, an officer or an employee of such international organisation as the Registrar may approve;
 - (iv) a member of a visiting military force who is approved by an authorised officer of the Ministry of Defence and who complies with such conditions for approval as the authorised officer may impose.
- (2) [*Deleted by S 476/2006*]
- (3) [*Deleted by S 476/2006*]
- (4) The licence of a private motor car or a business service passenger vehicle which is registered using a certificate of entitlement issued on or after 1st April 1998 and which has at any time been registered in the name of a statutory board, company, firm, society, club or an association and used for instructional purposes for

reward shall not be renewed if the car or vehicle is more than 10 years old.

Individual may register motor car as business service passenger vehicle or private motor car

40. An individual who uses his motor car for the purpose of any trade, business, profession or vocation may, at his option, register his motor car as a business service passenger vehicle or a private motor car.

Motor vehicle unfit or unsuitable for service

41.—(1) If, after a motor vehicle has been registered and licensed, it becomes, in the opinion of the Registrar, unfit or unsuitable for service, it shall not be used on any road, other than on a journey for the purpose of effecting repairs to the motor vehicle and for its subsequent inspection by the Authority or any authorised examiner referred to in section 90 of the Act.

(2) In the event mentioned in paragraph (1), a “VEHICLE UNDER INSPECTION” sign shall be displayed on the front windscreen at the nearside of the motor vehicle or, in the case of a motor cycle with side-car, on the front portion of the side-car, facing forwards so as to be clearly visible from the front at all times whether the motor vehicle is moving or stationary.

(3) While under inspection or until such time the vehicle passes the inspection, the registered owner or any person in charge of the vehicle shall ensure that the sign is not removed or tampered with in any way.

(4) It shall be an offence for anyone, except an officer authorised by the Registrar, to remove or tamper with the sign.

Transfer of licence to replacement vehicle

41A.—(1) Notwithstanding section 19(2) of the Act, upon the registration of a replacement vehicle under rule 3F —

- (a) the Registrar may transfer the licence issued for the original vehicle to the replacement vehicle; and

(b) the licence shall entitle the holder of the licence to use or keep the replacement vehicle for the remainder of the period of the licence.

(2) The transfer of a licence under paragraph (1)(a) shall not cause the date of commencement of a licence to be changed.

(3) The Registrar shall not be required to transfer the licence unless he is satisfied of the matters referred to in section 19(3) of the Act, with the necessary modifications and so far as may be relevant, in relation to the replacement vehicle.

PART VII

WEIGHT, MARKINGS AND SEATING CAPACITY

Maximum laden weight

42. The maximum laden weight of motor vehicles and trailers shall be determined by the Registrar in accordance with rules 43 and 44.

Maximum laden weight of motor vehicle

43.—(1) The owner of a motor vehicle which is constructed or adapted for use for the carriage of goods shall inform the Registrar of the maximum laden weight of the motor vehicle in accordance with the manufacturer's specification, if any, or shall otherwise provide the Registrar with such information as the Registrar may require in order to enable him to ascertain the maximum laden weight and the Registrar shall upon receiving such information, determine the maximum laden weight of the motor vehicle.

(2) The owner of a motor vehicle which is constructed or adapted for use for the carriage of goods shall cause to be painted, or otherwise clearly marked upon some conspicuous place on the vehicle to be determined by the Registrar, the following:

- (a) the maximum laden weight of the vehicle as determined by the Registrar;
- (b) the weight of the vehicle unladen;
- (c) his name and address;

- (d) the maximum speed at which it may be driven when not drawing a trailer.

Maximum laden weight of trailer

44.—(1) The owner of a trailer shall inform the Registrar of the maximum laden weight of the trailer in accordance with the manufacturer's specification, if any, or shall otherwise provide the Registrar with such information as the Registrar may require in order to enable him to ascertain the maximum laden weight and the Registrar shall upon receiving such information, determine the maximum laden weight of the trailer.

(2) The owner of a trailer shall cause to be painted or otherwise clearly marked upon some conspicuous place on the trailer to be determined by the Registrar the following:

- (a) the maximum laden weight of the trailer as determined by the Registrar;
- (b) the weight of the trailer unladen;
- (c) his name and address.

Markings

45.—(1) The markings prescribed under rules 43 and 44 shall be —

- (a) in English;
- (b) inscribed in white on a black surface in letters and figures not less than 25 mm in height; and
- (c) kept clean and unobscured.

(2) For the purpose of this rule, “white” includes the colour of polished aluminium or chromium plating.

Markings on plate

45A.—(1) The owner of any vehicle referred to in paragraph (2), (3) or (4) which is registered on or after 1st July 1996 shall cause to be affixed to the vehicle in some conspicuous place to be determined by the Registrar a rectangular plate —

- (a) constructed of aluminium or chromium plating or such other materials as approved by the Registrar;
 - (b) measuring not less than 100 mm by 60 mm; and
 - (c) marked, by a method such as hammering or stamping, with the particulars prescribed in paragraph (2), (3) or (4), as the case may be, in letters or figures which shall not be less than 5 mm in height and 3 mm in width.
- (2) In the case of a motor vehicle which is constructed or adapted for use for the carriage of goods, the plate shall be marked with —
- (a) the chassis number of the vehicle;
 - (b) the maximum laden weight of the vehicle as determined by the Registrar;
 - (c) the weight of the vehicle unladen;
 - (d) the number of persons, including the driver, who may be carried in the driver's cabin; and
 - (e) the suitable tyre size for the vehicle.
- (3) In the case of a public service vehicle (other than a taxi), the plate shall be marked with —
- (a) the chassis number of the vehicle;
 - (b) the maximum laden weight of the vehicle as determined by the Registrar;
 - (c) the weight of the vehicle unladen;
 - (d) the number of passengers which the vehicle is licensed to carry; and
 - (e) the suitable tyre size for the vehicle.
- (4) In the case of a trailer, the plate shall be marked with —
- (a) the chassis number of the vehicle;
 - (b) the maximum laden weight of the vehicle as determined by the Registrar;
 - (c) the weight of the vehicle unladen; and

(d) the suitable tyre size for the vehicle.

(5) Rules 43(2) and 44(2) of these Rules and rule 67 of the Road Traffic (Public Service Vehicles) Rules (R 14) shall not apply to any public service vehicle (other than a taxi) or motor vehicle which is constructed or adapted for use for the carriage of goods or trailer —

(a) registered on or after 1st July 1996; or

(b) registered before 1st July 1996 which is marked in accordance with this rule and rule 45B.

Marking of maximum speed

45B. The owner of a public service vehicle (other than a taxi) or a motor vehicle which is constructed or adapted for use for the carriage of goods or a trailer shall cause to be painted, or otherwise clearly marked upon some conspicuous place on the vehicle or trailer to be determined by the Registrar, the maximum speed in kilometres per hour at which the vehicle may be driven or, in the case of a trailer, drawn on a road.

Markings on light goods vehicles and small buses

45C.—(1) Where the registered owner of a relevant vehicle is a person specified in rule 3C(1)(a)(i) or (ii), he shall display the following information on the relevant vehicle in accordance with paragraph (4):

(a) the name and address of the person recorded with the Registrar of Businesses or the Registrar of Companies, as the case may be;

(b) the registration number issued to him by the Registrar of Businesses or the Registrar of Companies, as the case may be;

(c) the passenger capacity of the vehicle as entered in the register of vehicles;

(d) such other information as the Registrar may require.

(2) Where the registered owner of a relevant vehicle is a person specified in rule 3C(1)(a)(iii) or (iv) or (2), he shall display the

following information on the relevant vehicle in accordance with paragraph (4):

- (a) the name and address of the owner;
- (b) such other information as the Registrar may require.

(3) Where the registered owner of a relevant vehicle is a person specified in rule 3C(1)(a)(v), he shall display the following information on the relevant vehicle in accordance with paragraph (4):

- (a) the name and address of the business or undertaking under which the owner operates;
- (b) such other information as the Registrar may require.

(4) The information required to be displayed under this rule shall, not later than 7 days from the registration or transfer of a relevant vehicle, be displayed legibly on both sides of the vehicle, in such manner as the Registrar may direct, on a black background in white capital letters which shall be not less than 25 mm in height.

(5) The Registrar may, in his discretion and subject to such conditions as he considers fit, waive the requirements of this rule.

(6) In this rule —

“Registrar of Businesses” has the same meaning as in the Business Registration Act (Cap. 32);

“Registrar of Companies” has the same meaning as in the Companies Act (Cap. 50);

“relevant vehicle” means —

- (a) a light goods vehicle (except a goods-cum-passengers vehicle) or a bus having a maximum seating capacity of 10 persons (including the driver) which is registered on or after 1st July 2002; or
- (b) a light goods vehicle (except a goods-cum-passengers vehicle) or a small bus transferred under rule 25(1) or (6), 26(3) or 29 on or after 1st July 2002 to a person specified in rule 3C(1) or (2).

CNG identification marking

45D.—(1) The owner of a CNG vehicle shall cause to be exhibited on the —

- (a) front bumper; and
- (b) rear bumper or boot of the vehicle,

a CNG identification marking that conforms to the diagram and specifications in the Thirteenth Schedule.

(2) Every CNG identification marking shall be exhibited in a vertical position so that each letter of the CNG identification marking is vertical and easily distinguishable.

(3) No other figures or letters and no design advertisement or ornamentation shall be placed near the CNG identification marking in such a manner as to be likely to render it more difficult to identify the CNG identification marking when the CNG vehicle is in motion.

(4) Every CNG identification marking exhibited on a CNG vehicle shall be maintained in a clean and effective condition while the vehicle is on a road.

CNG system information marking

45E.—(1) The owner of a CNG vehicle shall cause to be exhibited on the vehicle in some conspicuous place to be determined by the Registrar, a CNG system information marking that displays all of the following information:

- (a) the names of the manufacturer, supplier and installer respectively, of the CNG system installed in the vehicle;
- (b) the date of installation of the CNG system;
- (c) the approved standard that the CNG system complies with;
- (d) the serial number, date of manufacture and working pressure of the compressed natural gas cylinder used in the CNG system;
- (e) such other information as the Registrar may require.

(2) The information referred to in paragraph (1) shall be displayed legibly —

- (a) in English; and
- (b) in letters or figures not less than 3 mm in height and width.

Prohibition

46. No person shall cause or permit a motor vehicle or trailer constructed or adapted for use for the carriage of goods to carry a load in excess of the maximum laden weight as determined by the Registrar under rules 43 and 44.

Determination of seating capacity

47.—(1) The seating capacity of public service vehicles shall be calculated in accordance with this rule.

(2) In determining the number of persons for whom any such vehicle has seating capacity (excluding the driver) —

- (a) where separate seats for each person are provided, one person shall be counted for each separate seat provided;
- (b) where the vehicle is fitted with continuous seats, one person shall be counted for each complete length of 400 mm measured on a straight line lengthwise on the rear of each such seat; and
- (c) where any such continuous seat is fitted with arms for the purpose of separating the seating spaces and the arms are so constructed that they can be folded back or otherwise put out of use, such seat shall be measured for the purposes of these Rules as if it had not been fitted with such arms.

(3) In calculating the seating capacity of any motor vehicle the driver's seat shall be excluded, and where the driver of a vehicle having a seating capacity for not more than 7 persons occupies a portion of a continuous seat, one person only shall be counted for the remaining portion of that seat, except where the Registrar otherwise permits.

(4) The number of passengers carried on —

- (a) a motor vehicle shall not exceed its licensed seating capacity; and

- (b) an omnibus shall not exceed its licensed seating and standing capacity.
- (5) For the purposes of paragraph (4) —
 - (a) infants in arms shall not be reckoned as passengers;
 - (b) where children below the age of 12 years are carried on any such vehicle, 3 of such children may be reckoned as 2 passengers; and
 - (c) where the rear passenger seat of a taxi has a seating capacity for 3 adult persons, such seat shall be deemed to have a seating capacity for 2 adult persons and 2 children below the age of 12 years.
- (6) Paragraph (5) shall not apply to school buses.

PART VIII

EXEMPTION FROM PAYMENT OF TAXES OR FEES

[S 46/2017 wef 15/02/2017]

- 48. *[Deleted by S 46/2017 wef 15/02/2017]*
- 49. *[Deleted by S 46/2017 wef 15/02/2017]*
- 50. *[Deleted by S 46/2017 wef 15/02/2017]*
- 51. *[Deleted by S 46/2017 wef 15/02/2017]*

Claims to exemption

52.—(1) A registered owner who wishes to claim exemption from the payment of any tax under section 11(1)(b) of the Act shall complete and deliver to the Registrar an application in such form as the Registrar may require.

(2) Any exemption from the payment of any tax shall be for a period not exceeding one year.

(3) Any claim for exemption shall be made annually.

Non-user

53.—(1) A registered owner who wishes to claim exemption from the payment of any tax under section 11(1)(b) of the Act on account of the non-user of any vehicle shall apply for such non-user in such form as the Registrar may require.

(1A) The registered owner shall furnish such other particulars or document as the Registrar may require in respect of his claim.

(2) A motor vehicle declared non-user shall not be used on a road repairable at public expense.

(3) The registered owner of the vehicle shall give prior notice to the Registrar if the vehicle is required to be moved from one place to another during the period of non-user.

(4) Failure to comply with this rule may disqualify the owner for refund or exemption of the licence fee.

(5) Motor vehicles reported stolen shall not be required to comply with the requirements of this rule.

(6) Any person who —

(a) in his application of non-user under paragraph (1) furnishes as the address at which the vehicle is kept an address at which the vehicle is not in fact so kept;

(b) fails to notify the Registrar if a vehicle put on non-user is moved from one place to another during the period of non-user; or

(c) furnishes any false or misleading particular or document under paragraph (1) or (1A),

shall be guilty of an offence.

(7) An application for exemption from the payment of licence fee shall be made for a period not exceeding one year.

(8) A fresh application shall be made after the expiry of one year if exemption for a further period is required.

(9) A fee of \$17.12 (inclusive of GST) shall be payable for every application of non-user made under paragraph (1).

[S 696/2017 wef 20/12/2017]

(10) This rule shall not apply to any vehicle which is registered as a classic vehicle.

Replacement engine or electric traction motors

54. The Registrar may refuse to issue a licence to a vehicle fitted with a replacement engine or electric traction motors unless he is satisfied as to the origin of the replacement engine or electric traction motors and that the replacement engine or electric traction motors is suitable or appropriate for use on that vehicle.

PART IX

SUPPLEMENTARY LICENCES

Issue of electronic supplementary licences for off-peak cars

55.—(1) The Registrar may, upon an application being made and on payment of the prescribed fee, issue a supplementary licence to the registered owner of an off-peak car to permit the off-peak car to be driven on any road during the times specified in the Fifth Schedule.

(2) Each supplementary licence shall be for a period of one day and subject to paragraph (3), the fee for a supplementary licence shall be \$20.

(3) The Registrar may, upon issuing a licence under Part VI for an off-peak car, issue without any charge to the registered owner of the off-peak car supplementary licences to permit it to be driven on any road during the times specified in the Fifth Schedule as follows:

- (a) 5 supplementary licences for every period of 12 months for which the licence issued is valid;
- (b) if the licence is issued for a shorter period, the largest whole number obtained if the supplementary licences are issued in the same proportion in relation to the period of the licence issued under Part VI.

- (4) Paragraph (3) shall apply only to off-peak cars —
- (a) in respect of which certificates of entitlement have been issued under rule 3(1)(f) of the Road Traffic (Motor Vehicles, Quota System) Rules (R 31); or
 - (b) which have been re-registered as off-peak cars before 1st September 1994.
- (5) The Registrar may, before issuing a supplementary licence, require the applicant to furnish such particulars or documents as he deems necessary.
- (6) Without prejudice to the right to apply under paragraph (8) or (10), non-electronic supplementary licences may not be used after 22nd November 2009.
- (7) A supplementary licence shall be in force only if —
- (a) the registered owner of an off-peak car issued with the supplementary licence has notified the Registrar, in the manner required by the Registrar, of his usage of the supplementary licence by submitting the identification mark of the off-peak car and the year, month and date of usage; and
 - (b) the notification is received before the expiry of the day immediately following the date of usage, regardless of public holidays.
- (8) The registered owner of an off-peak car or holder of a non-electronic supplementary licence may apply to the Registrar to cancel his unused supplementary licence or non-electronic supplementary licence, as the case may be, and for a refund of the fee paid, and the Registrar may, in his discretion and subject to such conditions as the Registrar may specify, grant a refund of the fee paid for the unused supplementary licence to the registered owner, or in the case of a non-electronic supplementary licence, to the holder of such licence.
- (9) The Registrar may, in his discretion, refund the fee paid for a supplementary licence issued under paragraph (1) to the registered owner of an off-peak car when —

- (a) the off-peak car has been declared non-user under rule 53;
- (b) the off-peak car is destroyed, scrapped or exported;
- (c) the off-peak car is taken permanently off the roads;
- (d) the off-peak car is seized under any written law;
- (e) the off-peak car is re-registered as a private motor car;
- (f) the registration of the off-peak car is transferred to another person; or
- (g) the registration of the off-peak car is cancelled under section 27(1) of the Act.

(10) Upon the application of the registered owner of an off-peak car, the Registrar may, in his discretion and subject to such conditions as he may specify, assign an unused supplementary licence to such person or such off-peak car as the Registrar may allow, or alter the date of the unused supplementary licence.

(11) In this rule, “supplementary licence” shall, unless the context otherwise requires, mean electronic supplementary licence.

Classic vehicle supplementary licences

55A.—(1) The Registrar may, upon issuing a licence under Part VI for a classic vehicle, issue to the owner of the classic vehicle without any charge, up to 28 supplementary licences for the calendar year in which the licence issued is valid or, if the licence is issued for a period of less than 12 months, the largest whole number obtained if the supplementary licences are issued on a pro-rata basis in relation to the period of the licence issued under Part VI.

(1A) The Registrar may, before issuing the supplementary licence or licences, require the applicant to furnish such particulars or documents as he deems necessary.

(2) The Registrar may, upon application and payment of the fee referred to in paragraph (3) by the owner of the classic vehicle, issue to the owner not more than 17 additional supplementary licences for the calendar year in which the licence issued is valid or, if the licence is issued for a period of less than 12 months, the largest whole number

obtained if the supplementary licences are issued on a pro-rata basis in relation to the period of the licence issued under Part VI.

(3) Each supplementary licence shall be for a period of one day and the fee for a supplementary licence shall be \$20.

(4) The Registrar shall refuse to accept any application from the owner of a classic vehicle for refund of the fee paid in respect of the issue of any supplementary licence to the owner.

(5) Any person who, for the purpose of obtaining the grant by the Registrar of any supplementary licence under this rule, furnishes to the Registrar (whether in his application or otherwise) any information or particulars which to the person's knowledge are false or in any material respect misleading shall be guilty of an offence.

Restricted vintage vehicle and revised use vintage vehicle supplementary licences

55B.—(1) The Registrar may, upon application and payment of the fee referred to in paragraph (2) by the owner of —

- (a) a restricted vintage vehicle; or
- (b) a revised use vintage vehicle,

issue to the owner not more than 28 supplementary licences for every calendar year.

(2) Each supplementary licence referred to in paragraph (1) shall be for a period of one day and the fee for a supplementary licence shall be \$10.

(3) The Registrar may, upon application and payment of the fee referred to in paragraph (4) by the owner of a revised use vintage vehicle, issue to the owner not more than 17 additional supplementary licences for every calendar year.

(4) Each supplementary licence referred to in paragraph (3) shall be for a period of one day and the fee for a supplementary licence shall be \$20.

(5) The Registrar shall refuse to accept any application from the owner of a restricted vintage vehicle or revised use vintage vehicle for

refund of the fee paid in respect of the issue of any supplementary licence to the owner.

(6) The Registrar may, before issuing the supplementary licences, require the owner to furnish such particulars or documents as the Registrar deems necessary.

(7) Any person who, for the purpose of obtaining the grant by the Registrar of any supplementary licence under this rule, furnishes to the Registrar (whether in his application or otherwise) any information or particulars which to the person's knowledge are false or in any material respect misleading shall be guilty of an offence.

Validity and display of supplementary licences

56.—(1) A supplementary licence that is issued in respect of a classic vehicle under rule 55A, or a restricted vintage vehicle or revised use vintage vehicle under rule 55B, shall be in force on the date indicated in the supplementary licence in accordance with paragraph (4).

(2) The supplementary licence shall —

- (a) in a case of a right-hand-drive motor car, whenever the motor car is being driven on a road, be displayed either on the left side of the front windscreen or the left side of the front window of the motor car in such a manner that the supplementary licence can be read from the front or left side of the motor car;
- (b) in a case of a left-hand-drive motor car, whenever the motor car is being driven on a road, be displayed either on the right side of the front windscreen or the right side of the front window of the motor car in such a manner that the supplementary licence can be read from the front or right side of the motor car; or
- (c) in a case of a motor cycle or scooter, whenever the motor cycle or scooter is being ridden on a road, be displayed in a conspicuous position on the left side of the motor cycle or scooter in front of the rider's seat in such a manner that the

supplementary licence can be read from the left side of the motor cycle or scooter.

(3) The supplementary licence shall have the date, the vehicle's identification mark and other particulars indicated in the supplementary licence in accordance with paragraph (4).

(4) The date (in the form of year, month and day) and the vehicle's identification mark shall, where required to be indicated by these Rules, be indicated in the supplementary licence in accordance with the instructions set out in these Rules.

(5) For the purposes of this Part, a supplementary licence shall not be valid if —

- (a) the licence is so torn, defaced or mutilated that the figures or other particulars are illegible;
- (b) the licence contains an alteration, erasure or other irregularity which indicates that it has been tampered with;
- (c) the period of validity of the licence has expired;
- (d) the licence does not indicate the vehicle's identification mark or the date in accordance with paragraph (4); or
- (e) the licence is displayed on a vehicle which carries a different identification mark from that indicated on the licence.

PART X

VISITOR'S PERMITS

[S 46/2017 wef 15/02/2017]

Visitor's permits

57.—(1) The owner of a motor vehicle not registered and licensed under the Act or in the States of Malaya who brings that motor vehicle into Singapore from any place outside Singapore or the States of Malaya shall, if he intends to use that motor vehicle under section 25 of the Act, notify the Registrar within 48 hours of such importation.

(2) The owner of such motor vehicle who desires to obtain a visitor's permit under section 25 of the Act shall —

- (a) apply to the Registrar in such form as the Registrar may require; and
- (b) pay to the Registrar the appropriate fee specified in the Second Schedule.

[S 46/2017 wef 15/02/2017]

(3) The index mark and registered number assigned to the motor vehicle in the place where it is registered and licensed shall be deemed to be the index mark and registration number which would have been assigned to it if the vehicle had been registered under section 26 of the Act and the provisions affecting such index mark and registration number and the display thereof shall apply with the necessary modifications.

(4) The Registrar shall keep and maintain an index of visitor's permits issued by him.

[S 46/2017 wef 15/02/2017]

(5) *[Deleted by S 46/2017 wef 15/02/2017]*

[S 46/2017 wef 15/02/2017]

Visitor's permit to be carried

57A. A visitor's permit must at all times be attached to and carried on the vehicle in respect of which the permit is issued.

[S 46/2017 wef 15/02/2017]

Display of visitor's permit

57B. A visitor's permit must be displayed on the vehicle in respect of which the permit is issued —

- (a) where the vehicle is a motor cycle with a sidecar, by exhibiting the permit in a conspicuous position —
 - (i) on the left side of the handlebar of the motor cycle; or
 - (ii) on the left side of the combination of the motor cycle and sidecar, in front of the driving seat;

- (b) where the vehicle is any other motor cycle, by exhibiting the permit in a conspicuous position on the left side of the motor cycle in front of the driving seat;
- (c) where the vehicle is a motor vehicle (not being a motor cycle) without a windscreen, by placing the permit in a transparent holder and exhibiting the permit in a conspicuous position on the left side of the vehicle; or
- (d) where the vehicle is any other motor vehicle (not being a motor cycle) fitted with a windscreen extending across the motor vehicle, by exhibiting the permit on the left lower corner of the windscreen facing forwards so that the permit can be read from the front of the vehicle at all times.

[S 46/2017 wef 15/02/2017]

Illegible visitor's permit not to be exhibited

57C. A person must not exhibit on any vehicle a visitor's permit on which the figures or particulars have become illegible or the colour has become altered by fading or otherwise.

[S 46/2017 wef 15/02/2017]

PART XI

GENERAL LICENCES

Application for general licence

58.—(1) A person desiring to apply under section 28 of the Act for a general licence in respect of all vehicles used by him shall apply to the Registrar in such form or manner as the Registrar may require.

(2) The Registrar may, before issuing the general licence, require the applicant to furnish such information or documents as he deems necessary.

(3) For the avoidance of doubt, the Registrar may impose different requirements under paragraphs (1) and (2) for different types of general licences.

(4) Unless the Registrar otherwise permits, the holder of a general licence which is not cancelled or suspended shall apply for a new licence before the existing licence expires.

General licence plates

59.—(1) The Registrar may, on being satisfied that the applicant is a bona fide manufacturer or repairer of or dealer in vehicles, issue to the applicant the appropriate licence in accordance with the application and subject to such conditions as the Registrar may impose.

(2) Every such licence shall contain —

- (a) the name and address of the person to whom the licence is issued;
- (b) the number of the identification plate allotted;
- (c) the date of expiry of the licence;
- (d) the amount of fee paid;
- (e) the date stamp of office of issue; and
- (f) the serial number of the licence.

(3) On receipt of a deposit of \$100, the Registrar may supply free of charge with each general licence, one set of general licence plates.

(4) A general licence shall not at any time be used upon a vehicle the registration of which has been cancelled under section 27 of the Act.

(5) The plates to be supplied by the Registrar —

- (a) shall conform to such specification as the Registrar may from time to time direct; and
- (b) shall not be altered in any way after they have been so supplied.

(6) The plates shall remain the property of the Registrar and shall, unless the Registrar otherwise permits, be returned immediately to the Registrar whenever the licence in respect of which they were supplied is cancelled, suspended or has expired.

(7) Any person to whom any plates are supplied under paragraph (3) shall be guilty of an offence if he without lawful excuse fails to return the plates to the Registrar immediately on the cancellation, suspension or expiration of the general licence issued to that person.

Position of plates and licence

60.—(1) The plates shall be —

- (a) fixed in front and at the back of the vehicle upon which they may be in use in the manner prescribed by these Rules with respect to the index mark and registration number assigned to vehicles under these Rules; and
- (b) carried at all times when the vehicle is in use under a general licence.

(2) The general licence without any addition or alteration to it shall be carried properly fixed on the front plate so as to be clearly visible at all times from the front of the vehicle when the vehicle is in use under that licence.

Approval to use general licence upon foreign vehicle

60A.—(1) Where a general licence has been issued in respect of vehicles which include one or more foreign vehicles, the holder of the licence shall, each time he wishes to use the licence upon a foreign vehicle, apply to the Registrar (in such form or manner as the Registrar may require) for approval to use the licence upon the foreign vehicle.

(2) The Registrar may, before granting any approval under paragraph (1), require the holder of the licence to furnish such information or documents as the Registrar deems necessary.

(3) The Registrar may grant the approval under paragraph (1) either unconditionally or subject to such conditions as he thinks fit to impose.

Furnishing of false or misleading information or documents

60B.—(1) A person who furnishes to the Registrar —

- (a) in relation to an application for a general licence in respect of vehicles which include one or more foreign vehicles, any information or document referred to in rule 58(2); or
- (b) in relation to an application for approval under rule 60A(1) or 61(4), any information or document referred to in rule 60A(2) or 61(5),

shall ensure that the information or document is not false or misleading in any material particular.

(2) Any person who furnishes to the Registrar —

- (a) in relation to an application for a general licence in respect of vehicles which include one or more foreign vehicles, any information or document referred to in rule 58(2) which to his knowledge is false or misleading in any material particular; or
- (b) in relation to an application for approval under rule 60A(1) or 61(4), any information or document referred to in rule 60A(2) or 61(5) which to his knowledge is false or misleading in any material particular,

shall be guilty of an offence.

Use of vehicle under general licence by person other than holder of licence

61.—(1) A general licence shall not be used by any person other than the holder of the licence.

(2) A holder of a general licence shall not allow or suffer the licence or the plates supplied in connection with the general licence to be used by any other person.

(3) This rule does not prohibit the use of a vehicle, upon which a general licence and the plates supplied in connection with the licence are used, by a person other than the holder of the licence if —

- (a) the holder of the licence, or a person bona fide employed by him and acting under his authority, is present and in charge of the vehicle;
- (b) the vehicle is constructed for use by one person only and is being used by a prospective purchaser for the purpose of any test or trial;
- (c) the vehicle is a vehicle which is not registered in Singapore or any other country and is being used, with the approval of the Registrar, by a person acting under the authority of the holder of the licence for the purpose of conveying the vehicle —
 - (i) from such authorised landing place or authorised point of entry as may be approved by the Registrar directly to the place where the holder of the licence conducts his business as a manufacturer or repairer of or dealer in vehicles or such other place as the Registrar may allow, for the vehicle to be modified or improved, kept for sale, serviced or repaired, as the case may be;
 - (ii) from the place where the holder of the licence conducts his business as a manufacturer or repairer of or dealer in vehicles directly to such other place as the Registrar may allow for the vehicle to be modified or improved, serviced or repaired, as the case may be, and directly back to the place of business, if applicable; or
 - (iii) from the place where the holder of the licence conducts his business as a manufacturer or repairer of or dealer in vehicles or from such other place as the Registrar had approved under sub-paragraph (i) or (ii) directly to such authorised departing place or authorised point of departure as may be approved by the Registrar, for the vehicle to be brought out of Singapore after it has been modified or improved, kept for sale, serviced or repaired, as the case may be; or

(d) the vehicle is an off-peak car and is being used, with the approval of the Registrar, by a person acting under the authority of the holder of the licence for the purpose of conveying the vehicle to a place as the Registrar may approve for the sealing of the vehicle's identification mark or for the breaking or removal of the identification mark.

(4) The holder of a general licence who wishes to use the general licence for any purpose specified in paragraph (3)(c) or (d) shall apply to the Registrar for approval in such form or manner as the Registrar may require.

(5) The Registrar may, before granting any approval for the purposes of paragraph (4), require the holder of the licence to furnish such information or documents as the Registrar deems necessary.

(6) In this rule and rule 62 "authorised departing place", "authorised landing place", "authorised point of departure" and "authorised point of entry" have the same meanings as in section 2 of the Immigration Act (Cap. 133).

Limitation of use

62.—(1) A general licence shall not be used upon any vehicle other than a vehicle which is in the possession of the holder of the licence in the course of his business as a manufacturer or repairer of or dealer in vehicles.

(2) A general licence shall not at any time be used upon a vehicle which is being used for the conveyance of passengers for hire or reward or upon a vehicle which is being used for the conveyance of goods in the course of trade or for the delivery or removal of goods.

(3) No vehicle shall be used under a general licence for any purpose other than a purpose for which the vehicle is authorised by these Rules to be used under that licence.

(4) Subject to paragraphs (1) and (2), a vehicle other than a foreign vehicle may be used under a general licence for any purpose connected with the business of the holder of the licence as a manufacturer or repairer of or dealer in vehicles, and so long as the

vehicle is bona fide being used for such purpose, the holder of the licence shall not, by reason only that some other or further use is being made of the vehicle, be deemed to contravene these Rules.

(5) Where a vehicle upon which the plates supplied under rule 59 and a general licence are being properly carried, used and displayed is not a foreign vehicle, it shall not be necessary for the vehicle to carry any other identification mark or licence in respect of the vehicle.

(6) Where a general licence is used upon a foreign vehicle, the purposes for which the holder of the licence may use the vehicle shall be restricted to the following:

(a) to convey the vehicle —

- (i) from such authorised landing place or authorised point of entry as may be approved by the Registrar directly to the place where the holder of the licence conducts his business as a manufacturer or repairer of or dealer in vehicles or to such other place as the Registrar may allow, for the vehicle to be serviced or repaired; or
- (ii) from the place where the holder of the licence conducts his business as a manufacturer or repairer of or dealer in vehicles directly to such other place as the Registrar may allow for the vehicle to be serviced or repaired and directly back to the place of business, if applicable; or
- (iii) from the place where the holder of the licence conducts his business as a manufacturer or repairer of or dealer in vehicles or from such other place as the Registrar may allow directly to such authorised departing place or authorised point of departure as may be approved by the Registrar, for the vehicle to be brought out of Singapore after it has been serviced or repaired;

(b) to test the vehicle after it has been serviced or repaired, such use of the vehicle to take place only during such times or at such places as may be approved by the Registrar.

63. [*Deleted by S 46/2017 wef 15/02/2017*]

Fees for general licence

64. The fees payable for a general licence shall be those specified in the Second Schedule.

PART XII

SPECIAL PURPOSE LICENCES

Application for special purpose licence

64A.—(1) A person desiring to apply under section 28A of the Act for a special purpose licence in respect of a vehicle to be used by him shall apply to the Registrar in such form as the Registrar may require.

(2) The application shall be accompanied by such particulars as the Registrar may require.

Special purpose licences

64B.—(1) On receipt of an application under rule 64A(1), the Registrar may —

- (a) upon payment of a processing fee of \$25.68 (inclusive of GST), issue a special purpose licence, subject to such conditions as he may think fit to impose; or

[S 696/2017 wef 20/12/2017]

- (b) reject the application without giving any reason.

(2) A holder of a special purpose licence shall comply with all the conditions in respect of the licence issued to him.

(3) Every licence issued under this rule shall, as from the date specified in the licence, be valid for such period as the Registrar may specify in the licence.

(4) The Registrar may require the vehicle to which a licence relates to carry an identification mark which conforms to the specifications set out in Diagrams 18 and 19 of the Fourth Schedule.

(5) The fees payable for a licence issued under this rule shall be the lowest amount calculated at the following rates or a combination of the following rates according to the period specified in the licence:

- (a) \$30 per day;
- (b) \$250 per month;
- (c) \$800 per half-year.

(6) Every licence issued under this rule shall at all times be carried on the vehicle in respect of which it is issued in such manner as the Registrar may specify.

(7) The Registrar may, in his discretion and subject to such conditions as he thinks fit, waive, in whole or in part, any fee payable under paragraph (1)(a) or (5).

PART XIII

DUPLICATE LICENCE OR PERMIT, REFUNDS AND DISPOSAL OF DEPOSITS

[S 46/2017 wef 15/02/2017]

Duplicate licence or permit

64C.—(1) A holder of a general licence, special purpose licence or visitor's permit must apply to the Registrar for a duplicate general licence, special purpose licence or visitor's permit in such manner as the Registrar may require if —

- (a) the licence or permit has been lost or destroyed;
- (b) the licence or permit has been accidentally defaced;
- (c) the figures or particulars on the licence or permit have become illegible; or
- (d) the colour of the licence or permit has been altered by fading or otherwise.

(2) The Registrar may issue a duplicate general licence, special purpose licence or visitor's permit upon being satisfied as to such loss, destruction, defacement, illegibility or alteration if —

(a) a fee of \$16.05 is paid; and

[S 696/2017 wef 20/12/2017]

(b) in all cases except where the licence or permit was lost or destroyed, the original licence or permit is surrendered to the Registrar.

(3) The duplicate general licence, special purpose licence or visitor's permit issued under paragraph (2) has the same effect as the original licence or permit.

(4) In any case where the original general licence, special purpose licence or visitor's permit is found at any time after the issue of the duplicate licence or permit for a lost licence or permit, the holder of the general licence, special purpose licence or visitor's permit must surrender the original licence or permit to the Registrar who issued the duplicate.

(5) To avoid doubt, failure to comply with paragraph (4) is an offence.

(6) The Registrar may, in his discretion, waive the fee payable under paragraph (2)(a) in whole or in part.

[S 46/2017 wef 15/02/2017]

Refunds

65.—(1) The holder of a licence issued under rule 36 or 38B, a general licence or a visitor's permit desiring to surrender the licence or permit and apply for a refund of part of the fee paid for the licence or permit must —

(a) make the application in such form as may be required by the Registrar; and

(b) deliver to the Registrar —

(i) in the case of a general licence, the plates supplied under rule 59 and the general licence; or

(ii) in the case of a visitor's permit, the visitor's permit.

[S 46/2017 wef 15/02/2017]

(2) Upon complying with paragraph (1), the holder of a licence issued under rule 36 or 38B, a general licence or a visitor's permit is entitled to be paid by the Registrar by way of rebate —

- (a) in the case of a licence issued under rule 36 or 38B, the amount by which the fee paid exceeds the amount payable at the monthly rate prescribed for the licence in respect of each complete calendar month which has expired as of the date on which the licence was cancelled by the Registrar;
- (b) in the case of a general licence, the amount by which the fee paid exceeds the amount payable at the monthly rate prescribed for the general licence in respect of each complete calendar month which has expired as of the date of receipt by the Registrar of the general licence and plates; or
- (c) in the case of a visitor's permit, the amount by which the fee paid exceeds the amount payable at the rate prescribed for the visitor's permit as pro-rated on a daily basis as of the date of receipt by the Registrar of the visitor's permit.

[S 46/2017 wef 15/02/2017]

(3) For the purposes of determining the number of complete calendar months expired under this rule, a part of a month shall be deemed to be a complete calendar month.

(4) Notwithstanding paragraphs (1), (2) and (3), if the period in respect of which the fee paid for a licence, other than a general licence, is refundable is less than one complete month, the amount refundable shall be pro-rated on a daily basis for that period.

(5) The holder of a visitor's permit or a general licence shall not be entitled to any rebate unless the amount to be refunded in accordance with this rule exceeds \$20.

[S 46/2017 wef 15/02/2017]

(6) The Registrar may refund part of the fee paid in respect of a licence issued under rule 36 or 38B if he is satisfied that the vehicle has been —

- (a) declared non-user under rule 53, taken off the roads permanently, destroyed or exported out of Singapore; or

(b) seized by a public authority under any written law.

[S 46/2017 wef 15/02/2017]

Disposal of deposits

66.—(1) A deposit made under rule 59(3) shall be forfeited if —

- (a) any plates supplied under that rule are lost, damaged or defaced; or
- (b) the person to whom such plates were issued fails to return them to the Registrar on the cancellation, suspension or expiration of the licence issued to him.

(2) Except as provided for in paragraph (1), the deposit shall be returned to the person who made the deposit on such person surrendering the licence and any plates issued to him.

Fee payable when vehicle ceases to be exempted

67.—(1) Where a motor vehicle in respect of which there is granted an exemption by the Minister from the payment in whole or in part of —

- (a) any fee payable under section 10 of the Act;
- (b) any levy payable under section 10A(2) of the Act;
- (c) any tax payable under section 11 of the Act; or
- (d) any carbon emission tax payable under section 11AA of the Act as in force immediately before 1 January 2018, or any vehicular emission tax payable under that section as in force on that date,

[S 777/2017 wef 01/01/2018]

ceases to be so exempt, an amount equal to the fee, levy or tax so exempted, or such part thereof as the Minister may determine, shall become payable immediately.

(2) The sum payable under paragraph (1) shall be paid by the person in possession of the vehicle.

PART XIV

AMENDMENT OR WITHDRAWAL OF APPLICATIONS

Amendment or withdrawal of applications

68.—(1) Except as otherwise provided by these Rules, the Registrar may —

- (a) upon being notified that any particular furnished in an application made under these Rules is incomplete or incorrect;
- (b) upon receipt of a request to withdraw an application made under these Rules; or
- (c) upon being notified that any particular previously furnished and entered in the register of vehicles is incomplete or incorrect,

make any correction or amendment to the application or register, or permit the withdrawal of the application, as the case may be.

(2) A fee of \$32.10 (inclusive of GST) is payable in respect of a correction or an amendment made or a withdrawal granted.

[S 696/2017 wef 20/12/2017]

(3) The Registrar may, in his discretion, waive in whole or in part the fee payable under paragraph (2).

PART XV

REGISTRATION AND RE-REGISTRATION OF CLASSIC
VEHICLES, NORMAL VINTAGE VEHICLES, RESTRICTED
VINTAGE VEHICLES AND REVISED USE VINTAGE
VEHICLES

Registration or re-registration of motor vehicles as classic vehicles

69.—(1) The Registrar may, in his discretion, upon application in an approved form by the owner of a motor vehicle —

- (a) register the motor vehicle as a classic vehicle subject to rules 6 and 7; or

- (b) re-register the motor vehicle as a classic vehicle upon receipt of a fee of \$100.
- (2) In granting an application under paragraph (1), the Registrar may impose such conditions as he thinks fit.
- (3) Section 11A of the Act shall apply to classic vehicles.
- (4) No classic vehicle may be re-registered as a motor vehicle of any other classification.
- (5) Where the registration of a motor vehicle had previously been cancelled under the Road Traffic Ordinance or the Act, the Registrar shall only allow such a motor vehicle to be registered again in Singapore subsequent to such cancellation if —
- (a) in the case of a motor car —
- (i) the registration of the motor car was cancelled before 1st July 2000; or
- (ii) the registration of the motor car was cancelled on or after 1st July 2000 and the car was not a classic vehicle or has not reached 35 years old at the time of such cancellation; or
- (b) in the case of a motor cycle or scooter —
- (i) the registration of the motor cycle or scooter was cancelled before 1st August 2012; or
- (ii) the registration of the motor cycle or scooter was cancelled on or after 1st August 2012 and the motor cycle or scooter was not a classic vehicle or has not reached 35 years of age at the time of such cancellation.
- (6) Unless the Registrar otherwise allows, no motor vehicle shall have its registration transferred under rule 25, 26, 27 or 29 if such vehicle's registration had previously been cancelled under the Road Traffic Ordinance or the Act and the Registrar subsequently permits such vehicle to be registered under this rule, unless a period of 5 years had elapsed after the date of the subsequent registration.

Registration of motor vehicles as normal vintage vehicles or revised use vintage vehicles

70.—(1) The Registrar may, in his discretion, upon application in an approved form by the owner of a motor vehicle —

- (a) register the motor vehicle as a normal vintage vehicle subject to rules 6 and 7; or
- (b) register the motor vehicle as a revised use vintage vehicle subject to rules 6 and 7.

(2) In granting an application under paragraph (1), the Registrar may impose such conditions as he thinks fit.

(3) Section 11A of the Act shall apply to revised use vintage vehicles.

(4) Unless the Registrar otherwise allows, no motor vehicle —

- (a) shall be registered under this rule if its registration had previously been cancelled under the Road Traffic Ordinance or the Act; or
- (b) shall have its registration transferred under rule 25, 26, 27 or 29 if such vehicle's registration had previously been cancelled under the Road Traffic Ordinance or the Act and the Registrar subsequently permits such vehicle to be registered under this rule, unless a period of 5 years had elapsed after the date of the subsequent registration.

Re-registration of normal vintage vehicles to allow for transfer

71.—(1) The registered owner of a normal vintage vehicle which is registered with a condition that the registration may not be transferred may apply to the Registrar to re-register his vehicle as a normal vintage vehicle without such a condition.

(2) An application under paragraph (1) shall be accompanied by —

- (a) a re-registration fee of \$100; and
- (b) the fee payable for a normal vintage vehicle under rule 7(1)(a) if such fee was not paid at the time of first registration of the vehicle.

Re-registration of restricted vintage vehicles as normal vintage vehicles

72.—(1) The registered owner of a restricted vintage vehicle which is registered with a condition that the registration may not be transferred may apply to the Registrar to re-register his vehicle as a normal vintage vehicle.

- (2) An application under paragraph (1) shall be accompanied by —
- (a) a re-registration fee of \$100;
 - (b) the fee payable for a normal vintage vehicle under rule 7(1)(a) if such fee was not paid at the time of first registration of the vehicle; and
 - (c) the levy payable for a normal vintage vehicle under section 10A(2) of the Act, subject to rule 24C of the Road Traffic (Motor Vehicles, Quota System) Rules (R 31).

Re-registration of normal vintage vehicles or restricted vintage vehicles as revised use vintage vehicles

73.—(1) The registered owner of a normal vintage vehicle or restricted vintage vehicle may apply to the Registrar to re-register his vehicle as a revised use vintage vehicle.

- (2) An application under paragraph (1) shall be accompanied by —
- (a) a re-registration fee of \$100;
 - (b) the fee payable for a revised use vintage vehicle under rule 7(1)(a) if such fee was not paid at the time of first registration of the vehicle; and
 - (c) the levy payable for a revised use vintage vehicle under section 10A(2) of the Act, subject to rule 24C of the Road Traffic (Motor Vehicles, Quota System) Rules (R 31).

(3) No refund of any fee or part thereof which has been paid for the first registration of a vehicle shall be made if it is re-registered as a vehicle of a description to which a lower rate of fee for the first registration of a vehicle of that description is applicable under Part II of the First Schedule.

(4) Where the levy under section 10A(2) of the Act is payable to re-register a vehicle under this rule, the permit previously issued under section 10A(1) of the Act to register that vehicle shall not have any residual value in respect of the period between the date of its re-registration and the date on which it would otherwise expire.

Re-registration of revised use vintage vehicles as normal vintage vehicles

74.—(1) The registered owner of a revised use vintage vehicle may apply to the Registrar to re-register his vehicle as a normal vintage vehicle, with the condition that the registration as a normal vintage vehicle may be transferred.

(2) An application under paragraph (1) shall be accompanied by —

- (a) a re-registration fee of \$100;
- (b) the positive difference between the fee under rule 7(1)(a) which would have been payable had the vehicle been first registered as a normal vintage vehicle and the fee payable under rule 7(1)(a) when the vehicle was first registered as a revised use vintage vehicle; and
- (c) the levy payable for a vintage vehicle under section 10A(2) of the Act, subject to rule 24C of the Road Traffic (Motor Vehicles, Quota System) Rules (R 31).

(3) No refund of any fee or part thereof which has been paid for the first registration of a vehicle shall be made if it is re-registered as a vehicle of a description to which a lower rate of fee for the first registration of a vehicle of that description is applicable under Part II of the First Schedule.

(4) Where the levy under section 10A(2) of the Act is payable to re-register a vehicle under this rule, the permit previously issued under section 10A(1) of the Act to register that vehicle shall not have any residual value in respect of the period between the date of its re-registration and the date on which it would otherwise expire.

FIRST SCHEDULE

PART I

Rules 6, 7 and 8

FEES TO BE PAID ON
REGISTRATION OF VEHICLE

- (1) The fee payable for the registration of motor vehicles and trailers using certificates of entitlement issued before 1st April 1998 shall be as follows:
- | | |
|---|----------|
| (a) motor cycles, scooters, mopeds or motor cycles with side-cars | \$5 |
| (b) goods-cum-passengers vehicles and trailers | \$15 |
| (c) private hire cars, private motor cars or off-peak cars | \$1,000 |
| (d) business service passenger vehicles | \$5,000 |
| (e) light goods vehicles | \$7,000 |
| (f) heavy goods vehicles and cement mixers | \$14,000 |
| (g) motor vehicles not falling within any of the categories, classes or descriptions of vehicles referred to in paragraphs (a) to (f) | \$15 |
- (2) The fee payable for the registration of a motor vehicle (excluding a taxi which replaces another taxi) using a certificate of entitlement issued on or after 1st April 1998 shall be \$220.
- (3) The fee payable for the registration of a taxi which replaces another taxi using a certificate of entitlement issued on or after 1st April 1998 but before 1st September 1998 shall be \$15.
- (4) The fee payable for the registration of a taxi which replaces another taxi using a certificate of entitlement issued on or after 1st September 1998 shall be \$220.
- (5) The fee payable for the registration of a motor vehicle which is exempted from section 10A(1) of the Act shall be \$220.

FIRST SCHEDULE — *continued*

- (6) The fee payable for the registration of a motor vehicle as a PU-registered vehicle shall be \$220.

[S 696/2017 wef 20/12/2017]

PART IA

Rule 3D(4)(b)

FEES TO BE PAID TO AUTHORITY FOR APPLICATION FOR
BATCH TYPE-APPROVAL IN RESPECT OF
UNREGISTERED VEHICLES

<i>Description of vehicle</i>	<i>Fee payable (inclusive of GST)</i>
Vehicle or batch of vehicles which falls under the category of —	
(a) motor cycles, scooters, mopeds and motor cycles with side-cars	\$89.88
(b) goods vehicles and goods-cum-passenger vehicles	\$256.80
(c) buses	\$256.80
(d) motor cars and any other vehicles (other than trailers)	\$256.80
(e) trailers	Nil

PART IB

Rule 3D(4)(c)

FEES TO BE PAID TO AUTHORITY FOR APPLICATION FOR
TYPE-APPROVAL IN RESPECT OF
UNREGISTERED VEHICLES

<i>Description of vehicle</i>	<i>Fee payable (inclusive of GST)</i>
Model of a vehicle which falls under the category of —	
(a) motor cycles, scooters, mopeds and motor cycles with side-cars	\$128.40

FIRST SCHEDULE — *continued*

<i>Description of vehicle</i>	<i>Fee payable (inclusive of GST)</i>
(b) goods vehicles and goods-cum-passenger vehicles	\$385.20
(c) buses	\$385.20
(d) motor cars and any other vehicles (other than trailers)	\$385.20
(e) trailers	Nil

PART IC

Rule 3D(4)(d)

FEES TO BE PAID TO THE AUTHORITY FOR APPLICATION FOR
MODIFIED TYPE-APPROVAL IN RESPECT OF
UNREGISTERED VEHICLES

<i>Description of vehicle</i>	<i>Fee payable (inclusive of GST)</i>
(1) Vehicle of a model which has been type-approved and the model of the vehicle is subsequently modified by its manufacturer outside Singapore, being a vehicle which falls under the category of —	
(a) motor cycles, scooters, mopeds and motor cycles with side-cars	\$42.80
(b) goods vehicles and goods-cum-passenger vehicles	\$128.40
(c) buses	\$128.40
(d) motor cars and any other vehicles (other than trailers)	\$128.40
(e) trailers	Nil
(2) Vehicle of a model which has been type-approved and the model of the vehicle is subsequently modified in Singapore or any part of the vehicle is	

FIRST SCHEDULE — *continued*

<i>Description of vehicle</i>	<i>Fee payable (inclusive of GST)</i>
manufactured in Singapore, being a vehicle which falls under the category of —	
(a) motor cycles, scooters, mopeds and motor cycles with side-cars	Nil
(b) goods vehicles and goods-cum-passenger vehicles	\$32.10
(c) buses	\$64.20
(d) motor cars and any other vehicles (other than trailers)	\$64.20
(e) trailers	\$32.10

[S 696/2017 wef 20/12/2017]

PART II

Rules 2(1), 3F(4), 7(1)(a), (3), (7) and (9), 8(8) and (8A), 73(3) and 74(3)

ADDITIONAL REGISTRATION FEE PAYABLE ON
THE REGISTRATION OF MOTOR VEHICLES
(OTHER THAN TAXIS) USING CERTIFICATES OF ENTITLEMENT
ISSUED BEFORE 1ST APRIL 1998

<i>Description</i>	<i>Fee payable</i>
(1) Motor vehicles not being a vehicle falling within any of the classes of vehicles set out in paragraphs (2) and (6), registered for the purpose of —	Fee equal to 55% of the value of the vehicle
(a) conveying passengers; or	
(b) conveying goods and passengers	
(2) Motor vehicles registered for the purpose of conveying either passengers or both passengers and goods and which fall under the category of —	

FIRST SCHEDULE — *continued*

<i>Description</i>	<i>Fee payable</i>
(a) new business service passenger vehicle	Fee equal to 150% of the value of the vehicle
(b) new private hire car	Fee equal to 150% of the value of the vehicle
(c) new private motor car	Fee equal to 150% of the value of the vehicle
(d) new off-peak car	Fee equal to 150% of the value of the vehicle
(e) new station wagon	Fee equal to 150% of the value of the vehicle
(f) secondhand business service passenger vehicle	Fee equal to 150% of the value of the vehicle plus \$10,000
(g) secondhand private motor car	Fee equal to 150% of the value of the vehicle plus \$10,000
(h) secondhand off-peak car	Fee equal to 150% of the value of the vehicle plus \$10,000
(i) secondhand station wagon	Fee equal to 150% of the value of the vehicle plus \$10,000
(j) new or secondhand goods-cum-passengers vehicle	Fee equal to 150% of the value of the vehicle
(3) Motor vehicle which is imported or which the Registrar is satisfied to be locally assembled and registered for the purpose of conveying goods only	Fee equal to 5% of the value of the vehicle
(4) Omnibus which is imported or which the Registrar is satisfied to be locally assembled and registered as a public service vehicle	Fee equal to 5% of the value of the vehicle
(5) Motor cycles and motor scooters	Fee equal to 15% of the value of the vehicle

FIRST SCHEDULE — *continued*

<i>Description</i>	<i>Fee payable</i>	
	<i>Fee payable for new bus</i>	<i>Fee payable for secondhand bus</i>
(6) School bus and private hire bus having a seating capacity —		
(a) not exceeding 15 passengers	\$ 4,000	\$ 5,000
(b) exceeding 15 passengers but not exceeding 30 passengers	\$ 8,000	\$10,000
(c) exceeding 30 passengers but not exceeding 45 passengers	\$12,000	\$15,000
(d) exceeding 45 passengers	\$16,000	\$20,000

ADDITIONAL REGISTRATION FEE PAYABLE ON
THE REGISTRATION OF MOTOR VEHICLES
(OTHER THAN TAXIS) USING CERTIFICATES OF ENTITLEMENT
ISSUED ON OR AFTER 1ST APRIL 1998
BUT BEFORE 4TH MAY 2002

<i>Description of vehicle</i>	<i>Fee payable</i>
(1) Motor vehicles not being a vehicle falling within any of the classes of vehicles set out in paragraphs (2) and (6), registered for the purpose of —	
(a) conveying passengers; or	Fee equal to 140% of the value of the vehicle
(b) conveying goods and passengers	Fee equal to 140% of the value of the vehicle
(2) Motor vehicles registered for the purpose of conveying either passengers or both passengers and goods and which fall under the category of —	
(a) new business service passenger vehicle	Fee equal to 140% of the value of the vehicle
(b) new private hire car	Fee equal to 140% of the value of the vehicle

FIRST SCHEDULE — *continued*

<i>Description of vehicle</i>	<i>Fee payable</i>
(c) new private motor car	Fee equal to 140% of the value of the vehicle
(d) new off-peak car	Fee equal to 140% of the value of the vehicle
(e) new station wagon	Fee equal to 140% of the value of the vehicle
(f) secondhand business service passenger vehicle	Fee equal to 140% of the value of the vehicle plus \$10,000
(g) secondhand private motor car	Fee equal to 140% of the value of the vehicle plus \$10,000
(h) secondhand off-peak car	Fee equal to 140% of the value of the vehicle plus \$10,000
(i) secondhand station wagon	Fee equal to 140% of the value of the vehicle plus \$10,000
(j) new or secondhand goods-cum-passengers vehicle	Fee equal to 140% of the value of the vehicle
(3) Motor vehicle which is imported or which the Registrar is satisfied is locally assembled and registered for the purpose of conveying goods only	Fee equal to 5% of the value of the vehicle
(4) Omnibus which is imported or which the Registrar is satisfied to be locally assembled and registered as a public service vehicle	Fee equal to 5% of the value of the vehicle
(5) Motor cycles and motor scooters	Fee equal to 15% of the value of the vehicle
(6) Buses	Fee equal to 5% of the value of the vehicle
(7) Engineering plant	Nil
(8) Trailer	Nil
(9) Mobile crane	Nil

FIRST SCHEDULE — *continued*

ADDITIONAL REGISTRATION FEE PAYABLE ON
THE REGISTRATION OF MOTOR VEHICLES
(OTHER THAN TAXIS) USING CERTIFICATES OF ENTITLEMENT
ISSUED ON OR AFTER 4TH MAY 2002
BUT BEFORE 28TH FEBRUARY 2004

<i>Description of vehicle</i>	<i>Fee payable</i>
(1) Motor vehicles not being a vehicle falling within any of the classes of vehicles set out in paragraphs (2) and (6), registered for the purpose of —	
(a) conveying passengers	Fee equal to 130% of the value of the vehicle
(b) conveying goods and passengers	Fee equal to 130% of the value of the vehicle
(2) Motor vehicles registered for the purpose of conveying either passengers or both passengers and goods and which fall under the category of —	
(a) new business service passenger vehicle	Fee equal to 130% of the value of the vehicle
(b) new private hire car	Fee equal to 130% of the value of the vehicle
(c) new private motor car	Fee equal to 130% of the value of the vehicle
(d) new off-peak car	Fee equal to 130% of the value of the vehicle
(e) new station wagon	Fee equal to 130% of the value of the vehicle
(f) secondhand business service passenger vehicle	Fee equal to 130% of the value of the vehicle plus \$10,000
(g) secondhand private motor car	Fee equal to 130% of the value of the vehicle plus \$10,000
(h) secondhand off-peak car	Fee equal to 130% of the value of the vehicle plus \$10,000

FIRST SCHEDULE — *continued*

<i>Description of vehicle</i>	<i>Fee payable</i>
(i) secondhand station wagon	Fee equal to 130% of the value of the vehicle plus \$10,000
(j) new or secondhand goods-cum-passengers vehicle	Fee equal to 130% of the value of the vehicle
(3) Motor vehicle which is imported or which the Registrar is satisfied is locally assembled and registered for the purpose of conveying goods only	Fee equal to 5% of the value of the vehicle
(4) Omnibus which is imported or which the Registrar is satisfied to be locally assembled and registered as a public service vehicle	Fee equal to 5% of the value of the vehicle
(5) Motor cycles and motor scooters	Fee equal to 15% of the value of the vehicle
(6) Buses	Fee equal to 5% of the value of the vehicle
(7) Engineering plant	Nil
(8) Trailer	Nil
(9) Mobile crane	Nil

ADDITIONAL REGISTRATION FEE PAYABLE ON
THE REGISTRATION OF MOTOR VEHICLES
(OTHER THAN TAXIS) USING CERTIFICATES OF ENTITLEMENT
ISSUED ON OR AFTER 28TH FEBRUARY 2004
BUT BEFORE 1ST MARCH 2008

<i>Description of vehicle</i>	<i>Fee payable</i>
(1) Motor vehicles, not being a vehicle falling within any of the classes of vehicles set out in paragraphs (2) and (6), registered for the purpose of —	
(a) conveying passengers	Fee equal to 110% of the value of the vehicle

FIRST SCHEDULE — *continued*

<i>Description of vehicle</i>	<i>Fee payable</i>
(b) conveying goods and passengers	Fee equal to 110% of the value of the vehicle
(2) Motor vehicles registered for the purpose of conveying either passengers or both passengers and goods and which fall under the category of —	
(a) new business service passenger vehicle	Fee equal to 110% of the value of the vehicle
(b) new private hire car	Fee equal to 110% of the value of the vehicle
(c) new private motor car	Fee equal to 110% of the value of the vehicle
(d) new off-peak car	Fee equal to 110% of the value of the vehicle
(e) new station wagon	Fee equal to 110% of the value of the vehicle
(f) secondhand business service passenger vehicle	Fee equal to 110% of the value of the vehicle
(g) secondhand private motor car	Fee equal to 110% of the value of the vehicle
(h) secondhand off-peak cars	Fee equal to 110% of the value of the vehicle
(i) secondhand station wagons	Fee equal to 110% of the value of the vehicle
(j) new or secondhand goods-cum-passengers vehicles	Fee equal to 110% of the value of the vehicle
(k) secondhand private hire car	Fee equal to 110% of the value of the vehicle
(3) Motor vehicle which is imported or which the Registrar is satisfied is locally assembled and registered	Fee equal to 5% of the value of the vehicle

FIRST SCHEDULE — *continued*

<i>Description of vehicle</i>	<i>Fee payable</i>
for the purpose of conveying goods only	
(4) Omnibus which is imported or which the Registrar is satisfied is locally assembled and registered as a public service vehicle	Fee equal to 5% of the value of the vehicle
(5) Motor cycles or motor scooters	Fee equal to 15% of the value of the vehicle
(6) Buses	Fee equal to 5% of the value of the vehicle
(7) Engineering plant	Nil
(8) Trailer	Nil
(9) Mobile crane	Nil

ADDITIONAL REGISTRATION FEE PAYABLE ON THE REGISTRATION OF MOTOR VEHICLES (OTHER THAN TAXIS) USING CERTIFICATES OF ENTITLEMENT ISSUED ON OR AFTER 1ST MARCH 2008 BUT BEFORE 26TH FEBRUARY 2013

<i>Description of vehicle</i>	<i>Fee payable</i>
(1) Motor vehicle, not being a vehicle falling within any of the classes of vehicles set out in paragraphs (2) and (6), registered for the purpose of —	
(a) conveying passengers	Fee equal to 100% of the value of the vehicle
(b) conveying goods and passengers	Fee equal to 100% of the value of the vehicle
(2) Motor vehicle registered for the purpose of conveying either passengers or both passengers and goods and which falls under the category of —	
(a) new business service passenger vehicle	Fee equal to 100% of the value of the vehicle

FIRST SCHEDULE — *continued*

<i>Description of vehicle</i>	<i>Fee payable</i>
(b) new private hire car	Fee equal to 100% of the value of the vehicle
(c) new private motor car	Fee equal to 100% of the value of the vehicle
(d) new off-peak car	Fee equal to 100% of the value of the vehicle
(e) new station wagon	Fee equal to 100% of the value of the vehicle
(f) secondhand business service passenger vehicle	Fee equal to 100% of the value of the vehicle
(g) secondhand private motor car	Fee equal to 100% of the value of the vehicle
(h) secondhand off-peak car	Fee equal to 100% of the value of the vehicle
(i) secondhand station wagon	Fee equal to 100% of the value of the vehicle
(j) new or secondhand goods-cum-passengers vehicle	Fee equal to 100% of the value of the vehicle
(k) secondhand private hire car	Fee equal to 100% of the value of the vehicle
(3) Motor vehicle which is imported or which the Registrar is satisfied is locally assembled and registered for the purpose of conveying goods only	Fee equal to 5% of the value of the vehicle
(4) Omnibus which is imported or which the Registrar is satisfied is locally assembled and registered as a public service vehicle	Fee equal to 5% of the value of the vehicle
(5) Motor cycle or motor scooter	Fee equal to 15% of the value of the vehicle
(6) Bus	Fee equal to 5% of the value of the vehicle

FIRST SCHEDULE — *continued*

<i>Description of vehicle</i>	<i>Fee payable</i>
(7) Engineering plant	Nil
(8) Trailer	Nil
(9) Mobile crane	Nil
(10) Motor cycle or scooter which is registered as a normal vintage vehicle	Fee equal to 15% of the value of the vehicle
(11) Motor car which is registered as a normal vintage vehicle	Fee equal to 100% of the value of the vehicle
(12) Motor cycle or scooter which is registered as a revised use vintage vehicle	Fee equal to 10% of the value of the vehicle
(13) Motor car which is registered as a revised use vintage vehicle	Fee equal to 10% of the value of the vehicle

ADDITIONAL REGISTRATION FEE PAYABLE ON
THE REGISTRATION OF MOTOR VEHICLES (OTHER
THAN TAXIS) USING CERTIFICATES OF ENTITLEMENT
ISSUED ON OR AFTER 26TH FEBRUARY 2013 BUT BEFORE
21ST FEBRUARY 2017 OR ON
THE REGISTRATION ON OR AFTER 26TH FEBRUARY
2013 BUT BEFORE 21ST FEBRUARY 2017 OF MOTOR VEHICLES (OTHER
THAN TAXIS)
EXEMPTED FROM SECTION 10A(1) OF THE ACT

<i>Description of vehicle</i>	<i>Fee payable</i>
(1) Motor vehicle registered for the purpose of conveying either passengers or both passengers and goods and which falls under the category of —	
(a) new business service passenger vehicle	An amount equal to the sum of — (a) 100% of the first \$20,000, or any part thereof, of the value of the vehicle;

FIRST SCHEDULE — *continued*

<i>Description of vehicle</i>	<i>Fee payable</i>
	(b) 140% of the next \$30,000, or any part thereof, of the value of the vehicle; and
	(c) 180% of the value of the vehicle in excess of \$50,000.
(b) new or secondhand goods-cum-passengers vehicle	An amount equal to the sum of — (a) 100% of the first \$20,000, or any part thereof, of the value of the vehicle; (b) 140% of the next \$30,000, or any part thereof, of the value of the vehicle; and (c) 180% of the value of the vehicle in excess of \$50,000.
(c) new off-peak car	An amount equal to the sum of — (a) 100% of the first \$20,000, or any part thereof, of the value of the vehicle; (b) 140% of the next \$30,000, or any part thereof, of the value of the vehicle; and (c) 180% of the value of the vehicle in excess of \$50,000.
(d) new private hire car	An amount equal to the sum of — (a) 100% of the first \$20,000, or any part thereof, of the value of the vehicle; (b) 140% of the next \$30,000, or any part thereof, of the value of the vehicle; and

FIRST SCHEDULE — *continued*

<i>Description of vehicle</i>	<i>Fee payable</i>
	(c) 180% of the value of the vehicle in excess of \$50,000.
(e) new private motor car	An amount equal to the sum of — (a) 100% of the first \$20,000, or any part thereof, of the value of the vehicle; (b) 140% of the next \$30,000, or any part thereof, of the value of the vehicle; and (c) 180% of the value of the vehicle in excess of \$50,000.
(f) new station wagon	An amount equal to the sum of — (a) 100% of the first \$20,000, or any part thereof, of the value of the vehicle; (b) 140% of the next \$30,000, or any part thereof, of the value of the vehicle; and (c) 180% of the value of the vehicle in excess of \$50,000.
(g) secondhand business service passenger vehicle	An amount equal to the sum of — (a) 100% of the first \$20,000, or any part thereof, of the value of the vehicle; (b) 140% of the next \$30,000, or any part thereof, of the value of the vehicle; and (c) 180% of the value of the vehicle in excess of \$50,000.
(h) secondhand private hire car	An amount equal to the sum of —

FIRST SCHEDULE — *continued*

<i>Description of vehicle</i>	<i>Fee payable</i>
	(a) 100% of the first \$20,000, or any part thereof, of the value of the vehicle;
	(b) 140% of the next \$30,000, or any part thereof, of the value of the vehicle; and
	(c) 180% of the value of the vehicle in excess of \$50,000.
(i) secondhand private motor car	An amount equal to the sum of — (a) 100% of the first \$20,000, or any part thereof, of the value of the vehicle;
	(b) 140% of the next \$30,000, or any part thereof, of the value of the vehicle; and
	(c) 180% of the value of the vehicle in excess of \$50,000.
(j) secondhand off-peak car	An amount equal to the sum of — (a) 100% of the first \$20,000, or any part thereof, of the value of the vehicle;
	(b) 140% of the next \$30,000, or any part thereof, of the value of the vehicle; and
	(c) 180% of the value of the vehicle in excess of \$50,000.
(k) secondhand station wagon	An amount equal to the sum of — (a) 100% of the first \$20,000, or any part thereof, of the value of the vehicle;

FIRST SCHEDULE — *continued*

<i>Description of vehicle</i>	<i>Fee payable</i>
	(b) 140% of the next \$30,000, or any part thereof, of the value of the vehicle; and
	(c) 180% of the value of the vehicle in excess of \$50,000.
(2) Motor car registered as —	
(a) a classic vehicle	An amount equal to the sum of —
	(a) 100% of the first \$20,000, or any part thereof, of the value of the vehicle;
	(b) 140% of the next \$30,000, or any part thereof, of the value of the vehicle; and
	(c) 180% of the value of the vehicle in excess of \$50,000.
(b) a normal vintage vehicle	An amount equal to the sum of —
	(a) 100% of the first \$20,000, or any part thereof, of the value of the vehicle;
	(b) 140% of the next \$30,000, or any part thereof, of the value of the vehicle; and
	(c) 180% of the value of the vehicle in excess of \$50,000.
(c) a revised use vintage vehicle	An amount equal to 10% of the value of the vehicle
(3) Motor cycle or scooter registered as —	
(a) a classic vehicle	An amount equal to 15% of the value of the vehicle

FIRST SCHEDULE — *continued*

<i>Description of vehicle</i>	<i>Fee payable</i>
(b) a normal vintage vehicle	An amount equal to 15% of the value of the vehicle
(c) a revised use vintage vehicle	An amount equal to 10% of the value of the vehicle
(4) Motor cycle or scooter which does not fall within the description of vehicles set out in paragraph (3)	An amount equal to 15% of the value of the vehicle
(5) Bus which is imported, or which the Registrar is satisfied is locally assembled, and which at the time of registration is licensed to be used only as an omnibus and not any other class of public service vehicle	An amount equal to 5% of the value of the vehicle
(6) Bus which does not fall within the description of vehicles set out in paragraph (5)	An amount equal to 5% of the value of the vehicle
(7) Motor vehicle which does not fall within any description of vehicles set out in paragraphs (1) to (6) and which is registered for the purposes of —	
(a) conveying passengers	An amount equal to the sum of — (a) 100% of the first \$20,000, or any part thereof, of the value of the vehicle; (b) 140% of the next \$30,000, or any part thereof, of the value of the vehicle; and (c) 180% of the value of the vehicle in excess of \$50,000.
(b) conveying goods and passengers	An amount equal to the sum of — (a) 100% of the first \$20,000, or any part thereof, of the value of the vehicle;

FIRST SCHEDULE — *continued*

<i>Description of vehicle</i>	<i>Fee payable</i>
	(b) 140% of the next \$30,000, or any part thereof, of the value of the vehicle; and
	(c) 180% of the value of the vehicle in excess of \$50,000.
(8) Motor vehicle which is imported, or which the Registrar is satisfied is locally assembled, and registered for the purpose of conveying goods only	An amount equal to 5% of the value of the vehicle
(9) Engineering plant	Nil
(10) Mobile crane	Nil
(11) Trailer	Nil

[S 60/2017 wef 21/02/2017]

ADDITIONAL REGISTRATION FEE PAYABLE ON THE
REGISTRATION OF MOTOR VEHICLES (OTHER THAN
TAXIS) USING CERTIFICATES OF ENTITLEMENT ISSUED
ON OR AFTER 21 FEBRUARY 2017 OR ON THE
REGISTRATION ON OR AFTER 21 FEBRUARY 2017
OF MOTOR VEHICLES (OTHER THAN TAXIS) EXEMPTED
FROM SECTION 10A(1) OF THE ACT

<i>Description of vehicle</i>	<i>Fee payable</i>
(1) Motor vehicle registered for the purpose of conveying either passengers or both passengers and goods and which falls under the category of —	
(a) new business service passenger vehicle	An amount equal to the sum of —
	(a) 100% of the first \$20,000, or any part of the first \$20,000, of the value of the vehicle;

FIRST SCHEDULE — *continued*

<i>Description of vehicle</i>	<i>Fee payable</i>
	(b) 140% of the next \$30,000, or any part of the next \$30,000, of the value of the vehicle; and
	(c) 180% of the value of the vehicle in excess of \$50,000.
(b) new or secondhand goods-cum-passengers vehicle	An amount equal to the sum of — (a) 100% of the first \$20,000, or any part of the first \$20,000, of the value of the vehicle; (b) 140% of the next \$30,000, or any part of the next \$30,000, of the value of the vehicle; and (c) 180% of the value of the vehicle in excess of \$50,000.
(c) new off-peak car	An amount equal to the sum of — (a) 100% of the first \$20,000, or any part of the first \$20,000, of the value of the vehicle; (b) 140% of the next \$30,000, or any part of the next \$30,000, of the value of the vehicle; and (c) 180% of the value of the vehicle in excess of \$50,000.
(d) new private hire car	An amount equal to the sum of — (a) 100% of the first \$20,000, or any part of the first \$20,000, of the value of the vehicle; (b) 140% of the next \$30,000, or any part of the next \$30,000, of the value of the vehicle; and (c) 180% of the value of the vehicle in excess of \$50,000.
(e) new private motor car	An amount equal to the sum of —

FIRST SCHEDULE — *continued*

<i>Description of vehicle</i>	<i>Fee payable</i>
	(a) 100% of the first \$20,000, or any part of the first \$20,000, of the value of the vehicle;
	(b) 140% of the next \$30,000, or any part of the next \$30,000, of the value of the vehicle; and
	(c) 180% of the value of the vehicle in excess of \$50,000.
(f) new station wagon	An amount equal to the sum of —
	(a) 100% of the first \$20,000, or any part of the first \$20,000, of the value of the vehicle;
	(b) 140% of the next \$30,000, or any part of the next \$30,000, of the value of the vehicle; and
	(c) 180% of the value of the vehicle in excess of \$50,000.
(g) secondhand business service passenger vehicle	An amount equal to the sum of —
	(a) 100% of the first \$20,000, or any part of the first \$20,000, of the value of the vehicle;
	(b) 140% of the next \$30,000, or any part of the next \$30,000, of the value of the vehicle; and
	(c) 180% of the value of the vehicle in excess of \$50,000.
(h) secondhand private hire car	An amount equal to the sum of —
	(a) 100% of the first \$20,000, or any part of the first \$20,000, of the value of the vehicle;
	(b) 140% of the next \$30,000, or any part of the next \$30,000, of the value of the vehicle; and

FIRST SCHEDULE — *continued*

<i>Description of vehicle</i>	<i>Fee payable</i>
	(c) 180% of the value of the vehicle in excess of \$50,000.
(i) secondhand private motor car	An amount equal to the sum of — (a) 100% of the first \$20,000, or any part of the first \$20,000, of the value of the vehicle; (b) 140% of the next \$30,000, or any part of the next \$30,000, of the value of the vehicle; and (c) 180% of the value of the vehicle in excess of \$50,000.
(j) secondhand off-peak car	An amount equal to the sum of — (a) 100% of the first \$20,000, or any part of the first \$20,000, of the value of the vehicle; (b) 140% of the next \$30,000, or any part of the next \$30,000, of the value of the vehicle; and (c) 180% of the value of the vehicle in excess of \$50,000.
(k) secondhand station wagon	An amount equal to the sum of — (a) 100% of the first \$20,000, or any part of the first \$20,000, of the value of the vehicle; (b) 140% of the next \$30,000, or any part of the next \$30,000, of the value of the vehicle; and (c) 180% of the value of the vehicle in excess of \$50,000.
(2) Motor car registered as —	
(a) a classic vehicle	An amount equal to the sum of — (a) 100% of the first \$20,000, or any part of the first \$20,000, of the value of the vehicle;

FIRST SCHEDULE — *continued*

<i>Description of vehicle</i>	<i>Fee payable</i>
	(b) 140% of the next \$30,000, or any part of the next \$30,000, of the value of the vehicle; and
	(c) 180% of the value of the vehicle in excess of \$50,000.
(b) a normal vintage vehicle	An amount equal to the sum of —
	(a) 100% of the first \$20,000, or any part of the first \$20,000, of the value of the vehicle;
	(b) 140% of the next \$30,000, or any part of the next \$30,000, of the value of the vehicle; and
	(c) 180% of the value of the vehicle in excess of \$50,000.
(c) a revised use vintage vehicle	An amount equal to 10% of the value of the vehicle.
(3) Motor cycle or scooter registered as —	
(a) a classic vehicle	An amount equal to the sum of —
	(a) 15% of the first \$5,000, or any part of the first \$5,000, of the value of the vehicle;
	(b) 50% of the next \$5,000, or any part of the next \$5,000, of the value of the vehicle; and
	(c) 100% of the value of the vehicle in excess of \$10,000.
(b) a normal vintage vehicle	An amount equal to the sum of —
	(a) 15% of the first \$5,000, or any part of the first \$5,000, of the value of the vehicle;
	(b) 50% of the next \$5,000, or any part of the next \$5,000, of the value of the vehicle; and

FIRST SCHEDULE — *continued*

<i>Description of vehicle</i>	<i>Fee payable</i>
	(c) 100% of the value of the vehicle in excess of \$10,000.
(c) a revised use vintage vehicle	An amount equal to 10% of the value of the vehicle.
(4) Motor cycle or scooter which does not fall within the description of vehicles set out in paragraph (3)	An amount equal to the sum of — (a) 15% of the first \$5,000, or any part of the first \$5,000, of the value of the vehicle; (b) 50% of the next \$5,000, or any part of the next \$5,000, of the value of the vehicle; and (c) 100% of the value of the vehicle in excess of \$10,000.
(5) Bus which is imported, or which the Registrar is satisfied is locally assembled, and which at the time of registration is licensed to be used only as an omnibus and not any other class of public service vehicle	An amount equal to 5% of the value of the vehicle.
(6) Bus which does not fall within the description of vehicles set out in paragraph (5)	An amount equal to 5% of the value of the vehicle.
(7) Motor vehicle which does not fall within any description of vehicles set out in paragraphs (1) to (6) and which is registered for the purpose of —	
(a) conveying passengers	An amount equal to the sum of — (a) 100% of the first \$20,000, or any part of the first \$20,000, of the value of the vehicle; (b) 140% of the next \$30,000, or any part of the next \$30,000, of the value of the vehicle; and

FIRST SCHEDULE — *continued*

<i>Description of vehicle</i>	<i>Fee payable</i>
	(c) 180% of the value of the vehicle in excess of \$50,000.
(b) conveying goods and passengers	An amount equal to the sum of — (a) 100% of the first \$20,000, or any part of the first \$20,000, of the value of the vehicle; (b) 140% of the next \$30,000, or any part of the next \$30,000, of the value of the vehicle; and (c) 180% of the value of the vehicle in excess of \$50,000.
(8) Motor vehicle which is imported, or which the Registrar is satisfied is locally assembled, and registered for the purpose of conveying goods only	An amount equal to 5% of the value of the vehicle.
(9) Engineering plant	Nil
(10) Mobile crane	Nil
(11) Trailer	Nil

[S 60/2017 wef 21/02/2017]

ADDITIONAL REGISTRATION FEE FOR TAXIS

<i>Description of taxi</i>	<i>Fee payable</i>
(1) New taxi registered using a certificate of entitlement issued before 1st April 1998	\$2,000
(2) Taxi which before 1st September 1998 replaces another taxi which is 6 years old or more	\$5,000
(3) Taxi which before 1st September 1998 replaces another taxi that is more than 5 years old but that is less than 6 years old	\$2,000

FIRST SCHEDULE — *continued*

<i>Description of taxi</i>	<i>Fee payable</i>
(4) Taxi which before 1st September 1998 replaces another taxi that is not more than 5 years old	Nil
(5) New taxi registered using a certificate of entitlement issued on or after 1st April 1998 but before 4th May 2002	140% of the value of the vehicle
(6) Taxi which on or after 1st September 1998 but before 4th May 2002 replaces another taxi (irrespective of the age of the taxi being replaced)	140% of the value of the vehicle
(7) New taxi registered using a certificate of entitlement issued on or after 4th May 2002 but before 28th February 2004	130% of the value of the vehicle
(8) Taxi which on or after 4th May 2002 but before 28th February 2004 replaces another taxi (irrespective of the age of the taxi being replaced)	130% of the value of the vehicle
(9) New taxi registered using a certificate of entitlement issued on or after 28th February 2004 but before 1st March 2008	110% of the value of the vehicle
(10) Taxi which on or after 28th February 2004 but before 1st March 2008 replaces another taxi (irrespective of the age of the taxi being replaced)	110% of the value of the vehicle
(11) New taxi registered using a certificate of entitlement issued on or after 1st March 2008 but before 26th February 2013	100% of the value of the vehicle
(12) Taxi which on or after 1st March 2008 but before 26th February 2013 replaces another taxi	100% of the value of the vehicle

FIRST SCHEDULE — *continued*

<i>Description of taxi</i>	<i>Fee payable</i>
(irrespective of the age of the taxi being replaced)	
(13) Taxi registered on or after 26th February 2013	An amount equal to the sum of — (a) 100% of the first \$20,000, or any part thereof, of the value of the vehicle; (b) 140% of the next \$30,000, or any part thereof, of the value of the vehicle; and (c) 180% of the value of the vehicle in excess of \$50,000.

PART IIA

Rule 7(1)(b) and (3)

ADDITIONAL REGISTRATION FEE PAYABLE ON THE
REGISTRATION ON OR AFTER 1ST JANUARY 2014 BUT BEFORE
21ST FEBRUARY 2017 OF
DE-REGISTERED VEHICLES AS CLASSIC VEHICLES
OR NORMAL VINTAGE VEHICLES OR
REVISED USE VINTAGE VEHICLES

<i>Description of vehicle</i>	<i>Fee payable</i>
(1) Motor car registered as —	
(a) a classic vehicle	An amount equal to the sum of — (a) 100% of the first \$20,000, or any part thereof, of the value of the vehicle; (b) 140% of the next \$30,000, or any part thereof, of the value of the vehicle; and (c) 180% of the value of the vehicle in excess of \$50,000.
(b) a normal vintage vehicle	An amount equal to the sum of —

FIRST SCHEDULE — *continued*

<i>Description of vehicle</i>	<i>Fee payable</i>
	(a) 100% of the first \$20,000, or any part thereof, of the value of the vehicle;
	(b) 140% of the next \$30,000, or any part thereof, of the value of the vehicle; and
	(c) 180% of the value of the vehicle in excess of \$50,000.
(c) a revised use vintage vehicle	An amount equal to 10% of the value of the vehicle
(2) Motor cycle or scooter registered as —	
(a) a classic vehicle	An amount equal to 15% of the value of the vehicle
(b) a normal vintage vehicle	An amount equal to 15% of the value of the vehicle
(c) a revised use vintage vehicle	An amount equal to 10% of the value of the vehicle

[S 60/2017 wef 21/02/2017]

ADDITIONAL REGISTRATION FEE PAYABLE ON THE
REGISTRATION ON OR AFTER 21 FEBRUARY 2017 OF
DE-REGISTERED VEHICLES AS CLASSIC VEHICLES OR
NORMAL VINTAGE VEHICLES OR REVISED USE VINTAGE
VEHICLES

<i>Description of vehicle</i>	<i>Fee payable</i>
(1) Motor car registered as —	
(a) a classic vehicle	An amount equal to the sum of —
	(a) 100% of the first \$20,000, or any part of the first \$20,000, of the value of the vehicle;
	(b) 140% of the next \$30,000, or any part of the next \$30,000, of the value of the vehicle; and

FIRST SCHEDULE — *continued*

<i>Description of vehicle</i>	<i>Fee payable</i>
	(c) 180% of the value of the vehicle in excess of \$50,000.
(b) a normal vintage vehicle	An amount equal to the sum of — (a) 100% of the first \$20,000, or any part of the first \$20,000, of the value of the vehicle; (b) 140% of the next \$30,000, or any part of the next \$30,000, of the value of the vehicle; and (c) 180% of the value of the vehicle in excess of \$50,000.
(c) a revised use vintage vehicle	An amount equal to 10% of the value of the vehicle.
(2) Motor cycle or scooter registered as —	
(a) a classic vehicle	An amount equal to the sum of — (a) 15% of the first \$5,000, or any part of the first \$5,000, of the value of the vehicle; (b) 50% of the next \$5,000, or any part of the next \$5,000, of the value of the vehicle; and (c) 100% of the value of the vehicle in excess of \$10,000.
(b) a normal vintage vehicle	An amount equal to the sum of — (a) 15% of the first \$5,000, or any part of the first \$5,000, of the value of the vehicle; (b) 50% of the next \$5,000, or any part of the next \$5,000, of the value of the vehicle; and (c) 100% of the value of the vehicle in excess of \$10,000.

FIRST SCHEDULE — *continued*

<i>Description of vehicle</i>	<i>Fee payable</i>
(c) a revised use vintage vehicle	An amount equal to 10% of the value of the vehicle.

[S 60/2017 wef 21/02/2017]

PART IIB

Rule 9C (2)

CARBON EMISSIONS REBATE FOR MOTOR CARS (OTHER THAN TAXIS) FIRST REGISTERED DURING PERIOD FROM 1 JANUARY 2013 TO 30 JUNE 2015 (BOTH DATES INCLUSIVE)

<i>Band</i>	<i>Carbon Emission Level</i>	<i>Rebate Amount</i>
Band A1	From 0 carbon dioxide gram per kilometre to 100 carbon dioxide grams per kilometre	\$20,000
Band A2	From 101 carbon dioxide grams per kilometre to 120 carbon dioxide grams per kilometre	\$15,000
Band A3	From 121 carbon dioxide grams per kilometre to 140 carbon dioxide grams per kilometre	\$10,000
Band A4	From 141 carbon dioxide grams per kilometre to 160 carbon dioxide grams per kilometre	\$5,000
Neutral carbon emission band — Band B	From 161 carbon dioxide grams per kilometre to 210 carbon dioxide grams per kilometre	Nil

CARBON EMISSIONS REBATE FOR MOTOR CARS (OTHER THAN TAXIS) FIRST REGISTERED DURING PERIOD FROM 1 JULY 2015 TO 31 DECEMBER 2017 (BOTH DATES INCLUSIVE)

[S 335/2017 wef 30/06/2017]

<i>Band</i>	<i>Carbon Emission Level</i>	<i>Rebate Amount</i>
Band A1	From 0 carbon dioxide gram per kilometre to 95 carbon dioxide grams per kilometre	\$30,000

FIRST SCHEDULE — *continued*

Band A2	From 96 carbon dioxide grams per kilometre to 105 carbon dioxide grams per kilometre	\$15,000
Band A3	From 106 carbon dioxide grams per kilometre to 120 carbon dioxide grams per kilometre	\$10,000
Band A4	From 121 carbon dioxide grams per kilometre to 135 carbon dioxide grams per kilometre	\$5,000
Neutral carbon emission band — Band B	From 136 carbon dioxide grams per kilometre to 185 carbon dioxide grams per kilometre	Nil

[S 359/2015 wef 01/07/2015]

PART IIC

Rule 9C(2)

CARBON EMISSIONS REBATE FOR TAXIS FIRST REGISTERED DURING PERIOD FROM 1 JANUARY 2013 TO 30 JUNE 2015 (BOTH DATES INCLUSIVE)

<i>Band</i>	<i>Carbon Emission Level</i>	<i>Rebate Amount</i>
Band A1	From 0 carbon dioxide gram per kilometre to 100 carbon dioxide grams per kilometre	\$30,000
Band A2	From 101 carbon dioxide grams per kilometre to 120 carbon dioxide grams per kilometre	\$22,500
Band A3	From 121 carbon dioxide grams per kilometre to 140 carbon dioxide grams per kilometre	\$15,000
Band A4	From 141 carbon dioxide grams per kilometre to 160 carbon dioxide grams per kilometre	\$7,500
Neutral carbon emission band — Band B	From 161 carbon dioxide grams per kilometre to 210 carbon dioxide grams per kilometre	Nil

FIRST SCHEDULE — *continued*

**CARBON EMISSIONS REBATE FOR TAXIS FIRST REGISTERED
DURING PERIOD FROM 1 JULY 2015 TO 31 DECEMBER 2017 (BOTH
DATES INCLUSIVE)**

[S 335/2017 wef 30/06/2017]

<i>Band</i>	<i>Carbon Emission Level</i>	<i>Rebate Amount</i>
Band A1	From 0 carbon dioxide gram per kilometre to 95 carbon dioxide grams per kilometre	\$45,000
Band A2	From 96 carbon dioxide grams per kilometre to 105 carbon dioxide grams per kilometre	\$22,500
Band A3	From 106 carbon dioxide grams per kilometre to 120 carbon dioxide grams per kilometre	\$15,000
Band A4	From 121 carbon dioxide grams per kilometre to 135 carbon dioxide grams per kilometre	\$7,500
Neutral carbon emission band — Band B	From 136 carbon dioxide grams per kilometre to 185 carbon dioxide grams per kilometre	Nil

[S 359/2015 wef 01/07/2015]

PART III

Rule 10

[S 777/2017 wef 01/01/2018]

EMISSION BANDS FOR PRESCRIBED VEHICULAR EMISSIONS

<i>Prescribed vehicular emission</i>	<i>Unit of measurement of emission level</i>	<i>Band A1</i>	<i>Band A2</i>	<i>Band B (neutral emission band)</i>
Carbon dioxide (CO ₂)	g/km	A1 ≤ 90	90 < A2 ≤ 125	125 < B ≤ 160
Carbon monoxide (CO)	g/km	A1 ≤ 0.150	0.150 < A2 ≤ 0.190	0.190 < B ≤ 0.270
Hydrocarbons (HC)	g/km	A1 ≤ 0.020	0.020 < A2 ≤ 0.036	0.036 < B ≤ 0.052

FIRST SCHEDULE — *continued*

<i>Prescribed vehicular emission</i>	<i>Unit of measurement of emission level</i>	<i>Band A1</i>	<i>Band A2</i>	<i>Band B (neutral emission band)</i>
Oxides of nitrogen (NO _x)	g/km	$A1 \leq 0.007$	$0.007 < A2 \leq 0.013$	$0.013 < B \leq 0.024$

[S 777/2017 wef 01/01/2018]

PART IV

Rules 25(2) and (6), 26(3), 29(2) and
30(1)

FEE TO BE PAID ON TRANSFER OF
REGISTRATION OF A VEHICLE

Fee to be paid on the transfer of registration of any vehicle \$25

[S 696/2017 wef 20/12/2017]

PART V

Rule 8(18) and (20)

PREFERENTIAL SCALE

<i>Description of vehicle</i>	<i>Fee payable</i>
Motor vehicle having a cylinder capacity of —	
(1) not exceeding 1,000 cubic centimetres	Fee equal to 45% of the fee set out in Part II of this Schedule
(2) exceeding 1,000 cubic centimetres but not exceeding 1,600 cubic centimetres	Fee equal to 50% of the fee set out in Part II of this Schedule
(3) exceeding 1,600 cubic centimetres but not exceeding 2,000 cubic centimetres	Fee equal to 55% of the fee set out in Part II of this Schedule
(4) exceeding 2,000 cubic centimetres but not exceeding 3,000 cubic centimetres	Fee equal to 60% of the fee set out in Part II of this Schedule

FIRST SCHEDULE — *continued*

<i>Description of vehicle</i>	<i>Fee payable</i>
(5) exceeding 3,000 cubic centimetres	Fee equal to 65% of the fee set out in Part II of this Schedule

PART VI

Rule 8(7)(a)

<i>Cylinder capacity of old vehicle</i>	<i>Amount of rebate allowable</i>
(1) 1,000 cc and below	\$ 9,200
(2) 1,001 cc — 1,600 cc	\$11,200
(3) 1,601 cc — 2,000 cc	\$29,000
(4) 2,001 cc — 3,000 cc	\$43,700
(5) Above 3,000 cc	\$49,300

PART VII

Rule 8(7)(b)

<i>Age of old vehicle at the time of its de-registration</i>	<i>Amount of rebate allowable, expressed as a percentage of the value of the old vehicle as determined by the Registrar under rule 7(3) at the date of its registration</i>
(1) Not exceeding 5 years	130%
(2) Exceeding 5 years but not exceeding 6 years	120%
(3) Exceeding 6 years but not exceeding 7 years	110%
(4) Exceeding 7 years but not exceeding 8 years	100%
(5) Exceeding 8 years but not exceeding 9 years	90%
(6) Exceeding 9 years but not exceeding 10 years	80%
(7) Exceeding 10 years	Nil

FIRST SCHEDULE — *continued*

PART VIIA

Rule 8(7)(c), (d) and (e)

<i>Age of old vehicle at the time of its de-registration</i>	<i>Amount of rebate allowable, expressed as a percentage of the relevant additional registration fee as determined under rule 8(8)</i>
(1) Not exceeding 5 years	75%
(2) Exceeding 5 years but not exceeding 6 years	70%
(3) Exceeding 6 years but not exceeding 7 years	65%
(4) Exceeding 7 years but not exceeding 8 years	60%
(5) Exceeding 8 years but not exceeding 9 years	55%
(6) Exceeding 9 years but not exceeding 10 years	50%
(7) Exceeding 10 years	Nil

PART VIII

Rule 8(7)(f)

<i>Age of old vehicle at the time of its de-registration</i>	<i>Amount of rebate allowable, expressed as a percentage of the value of the old vehicle as determined by the Registrar under rule 7(3) at the date of its registration</i>
(1) Not exceeding 5 years	125%
(2) Exceeding 5 years but not exceeding 6 years	120%
(3) Exceeding 6 years but not exceeding 7 years	110%
(4) Exceeding 7 years but not exceeding 8 years	100%

FIRST SCHEDULE — *continued*

<i>Age of old vehicle at the time of its de-registration</i>	<i>Amount of rebate allowable, expressed as a percentage of the value of the old vehicle as determined by the Registrar under rule 7(3) at the date of its registration</i>
(5) Exceeding 8 years	Nil

PART IX

Rule 8(7)(d) and (e)

<i>Age of old vehicle at the time of its de-registration</i>	<i>Amount of rebate allowable, expressed as a percentage of the relevant additional registration fee as determined under rule 8(8)</i>
(1) Not exceeding 5 years	75%
(2) Exceeding 5 years but not exceeding 6 years	70%
(3) Exceeding 6 years but not exceeding 7 years	65%
(4) Exceeding 7 years but not exceeding 8 years	60%
(5) Exceeding 8 years	Nil

PART X

Rule 8(7)(g)

<i>Age of old vehicle at the time of its de-registration</i>	<i>Amount of rebate allowable, expressed as a percentage of the relevant additional registration fee as determined under rule 8(8A)</i>
(1) Not exceeding 5 years	75%
(2) Exceeding 5 years but not exceeding 6 years	70%
(3) Exceeding 6 years but not exceeding 7 years	65%

FIRST SCHEDULE — *continued*

<i>Age of old vehicle at the time of its de-registration</i>	<i>Amount of rebate allowable, expressed as a percentage of the relevant additional registration fee as determined under rule 8(8A)</i>
(4) Exceeding 7 years but not exceeding 8 years	60%
(5) Exceeding 8 years but not exceeding 9 years	55%
(6) Exceeding 9 years but not exceeding 10 years	50%
(7) Exceeding 10 years	Nil

[S 359/2015 wef 01/07/2015]

SECOND SCHEDULE

Rules 12B(9), 36(4) and (8), 57(2) and
64

FEES PAYABLE FOR LICENCES FOR MOTOR VEHICLES

<i>Description of vehicle</i>	<i>Fee payable half-yearly</i>
1.—(1) Private motor cars registered as school bus constructed for the carriage of 6 passengers or fewer, excluding the driver	5 cents per cubic centimetre of cylinder capacity (subject to a minimum of \$10)
(2) Private motor cars, business service passenger vehicles and private hire cars constructed for the carriage of not exceeding 6 passengers, excluding the driver, and having a cylinder capacity of —	
(a) not exceeding 1,000 cubic centimetres	35 cents per cubic centimetre of cylinder capacity
(b) exceeding 1,000 cubic centimetres but not exceeding 1,600 cubic centimetres	45 cents per cubic centimetre of cylinder capacity
(c) exceeding 1,600 cubic centimetres but not exceeding 2,000 cubic centimetres	52.5 cents per cubic centimetre of cylinder capacity

SECOND SCHEDULE — *continued*

<i>Description of vehicle</i>	<i>Fee payable half-yearly</i>
(d) exceeding 2,000 cubic centimetres but not exceeding 3,000 cubic centimetres	62.5 cents per cubic centimetre of cylinder capacity
(e) exceeding 3,000 cubic centimetres	87.5 cents per cubic centimetre of cylinder capacity
(3) Private motor cars, business service passenger vehicles and private hire cars constructed for the carriage of 7 or more passengers, excluding the driver	In addition to the fees specified in sub-paragraph (2), a fee of 50 cents for each month for every passenger in excess of 7 passengers authorised to be carried in the vehicle
(4) Business service passenger vehicles registered using a certificate of entitlement issued before 1st April 1998	In addition to the fees specified in sub-paragraphs (2) and (3), a fee equal to 100% of the fees specified in paragraphs (2) and (3)
(5) Business service passenger vehicles registered using a certificate of entitlement issued on or after 1st April 1998 and private motor cars transferred to a statutory board, company, firm, society, association or club on or after 1st April 1998	Fees as specified in sub-paragraphs (2) and (3)
(6) Motor cycles and scooters having a cylinder capacity of —	
(a) not exceeding 100 cubic centimetres	\$10
(b) exceeding 100 cubic centimetres but not exceeding 200 cubic centimetres	\$15
(c) exceeding 200 cubic centimetres but not exceeding 300 cubic centimetres	7½ cents per cubic centimetre of cylinder capacity
(d) exceeding 300 cubic centimetres but not exceeding 500 cubic centimetres	10 cents per cubic centimetre of cylinder capacity

SECOND SCHEDULE — *continued*

<i>Description of vehicle</i>	<i>Fee payable half-yearly</i>
(e) exceeding 500 cubic centimetres	12½ cents per cubic centimetre of cylinder capacity
2.—(1) Private hire car with a seating capacity of 6 passengers or fewer	In addition to the fee specified in paragraph 1(2), a fee of \$3.50 for each month or part thereof for every passenger authorised to be carried in the vehicle
(2) Private hire car with a seating capacity of more than 6 passengers	In addition to the fee specified in paragraph 1(2), a fee of \$4.20 for each month or part thereof for every passenger authorised to be carried in the vehicle
3. Taxis	\$550
4. Buses with —	
(a) SBS index marks	\$2,750
(b) TIB index marks	\$2,750
5. School buses, private buses and private hire buses equipped with engines using petroleum as fuel and constructed for the carriage of passengers —	
(a) not exceeding 15 persons	\$100
(b) exceeding 15 but not exceeding 30 persons	\$150
(c) exceeding 30 persons	\$200
6. Buses equipped with engines using diesel oil as fuel and registered as —	
(a) school buses constructed for the carriage of passengers —	
(i) not exceeding 15 persons	\$200
(ii) exceeding 15 but not exceeding 30 persons	\$400

SECOND SCHEDULE — *continued*

<i>Description of vehicle</i>	<i>Fee payable half-yearly</i>
(iii) exceeding 30 but not exceeding 45 persons	\$600
(iv) exceeding 45 persons	\$800
(b) private buses constructed for the carriage of passengers —	
(i) not exceeding 15 persons	\$600
(ii) exceeding 15 but not exceeding 30 persons	\$800
(iii) exceeding 30 but not exceeding 45 persons	\$1,200
(iv) exceeding 45 persons	\$1,600
(c) private hire buses constructed for the carriage of passengers —	
(i) not exceeding 15 persons	\$650
(ii) exceeding 15 but not exceeding 30 persons	\$1,200
(iii) exceeding 30 but not exceeding 45 persons	\$2,000
(iv) exceeding 45 persons	\$2,500
(d) excursion buses constructed for the carriage of passengers —	
(i) not exceeding 30 persons	\$1,200
(ii) exceeding 30 but not exceeding 45 persons	\$2,000
(iii) exceeding 45 persons	\$2,500
(e) buses with CSS index marks and constructed for the carriage of passengers —	
(i) not exceeding 30 persons	\$400
(ii) exceeding 30 but not exceeding 46 persons	\$600
(iii) exceeding 46 persons	\$800

SECOND SCHEDULE — *continued*

<i>Description of vehicle</i>	<i>Fee payable half-yearly</i>
(f) buses with SH and SABS index marks and constructed for the carriage of passengers —	
(i) not exceeding 45 persons	\$2,000
(ii) exceeding 45 persons	\$2,500
7.—(1) Station wagons (passengers only) —	
(a) with a seating capacity of 7 passengers or fewer, excluding the driver	Fee as specified in paragraph 1(2)
(b) with a seating capacity of more than 7 passengers, excluding the driver	In addition to the fees specified in paragraph 1(2), a fee of 50 cents for each month for every passenger in excess of 7 passengers authorised to be carried in the vehicle
(2) Goods-cum-passengers vehicles having a cylinder capacity of —	
(a) not exceeding 1,000 cubic centimetres	27.5 cents per cubic centimetre of cylinder capacity
(b) exceeding 1,000 cubic centimetres but not exceeding 1,600 cubic centimetres	35 cents per cubic centimetre of cylinder capacity
(c) exceeding 1,600 cubic centimetres but not exceeding 2,000 cubic centimetres	40 cents per cubic centimetre of cylinder capacity
(d) exceeding 2,000 cubic centimetres but not exceeding 3,000 cubic centimetres	47.5 cents per cubic centimetre of cylinder capacity
(e) exceeding 3,000 cubic centimetres	67.5 cents per cubic centimetre of cylinder capacity

In addition to the fees specified in this sub-paragraph, the following fee is payable:

SECOND SCHEDULE — *continued*

<i>Description of vehicle</i>	<i>Fee payable half-yearly</i>
(i) not exceeding 0.5 metric ton in weight unladen	\$18
(ii) not exceeding 1 metric ton in weight unladen	\$36
(iii) not exceeding 1.5 metric tons in weight unladen	\$54
(iv) not exceeding 2 metric tons in weight unladen	\$72
(v) not exceeding 2.5 metric tons in weight unladen	\$90
(vi) for every additional 0.5 metric ton in weight unladen or part thereof	\$18
8.—(1) All goods vehicles, other than light goods vehicles, heavy goods vehicles or goods-cum-passengers vehicles not exceeding —	
(a) 1.0 metric ton in weight unladen	\$72
(b) 1.5 metric tons in weight unladen	\$108
(c) 2.0 metric tons in weight unladen	\$144
(d) 2.5 metric tons in weight unladen	\$180
(e) 3.0 metric tons in weight unladen	\$216
(f) 3.5 metric tons in weight unladen	\$252
(g) 4.0 metric tons in weight unladen	\$288
(h) 4.5 metric tons in weight unladen	\$324
(i) 5.0 metric tons in weight unladen	\$360
(j) 5.5 metric tons in weight unladen	\$396
(k) 6.0 metric tons in weight unladen	\$432
(l) 6.5 metric tons in weight unladen	\$468
(m) 7.0 metric tons in weight unladen	\$504
(n) 7.5 metric tons in weight unladen	\$540

SECOND SCHEDULE — *continued*

<i>Description of vehicle</i>	<i>Fee payable half-yearly</i>
For every additional 0.5 metric ton in weight unladen or part thereof	\$36
(2) Cranes	Fee as specified in paragraph 1(1)
9.—(1) Motor vehicles used for instructional purposes for reward and any motor vehicles other than those charged with licence fees under the other provisions of this Schedule	In addition to the fees specified in paragraph 1(2), a half-yearly fee of \$40
(2) Goods vehicles used for instructional purposes for reward	In addition to the fees specified in paragraph 8(1), a half-yearly fee of \$40
10. General licences —	
(a) in respect of motor cycles which are not foreign vehicles	\$60
(b) in respect of vehicles (other than motor cycles) which are not foreign vehicles	\$800
(c) in respect of vehicles which include one or more foreign vehicles	\$1,200
11. Visitor's permits —	
(a) not exceeding 30 days	\$7.50
(b) exceeding 30 days but not exceeding 60 days	\$16
(c) exceeding 60 days but not exceeding 90 days	\$22.50
12. Light and heavy goods vehicles using petroleum as fuel —	
<i>Maximum laden weight</i>	
(a) not exceeding 3 metric tons	\$150
(b) exceeding 3 metric tons but not exceeding 5 metric tons	\$175
(c) exceeding 5 metric tons but not exceeding 10 metric tons	\$225

SECOND SCHEDULE — *continued*

<i>Description of vehicle</i>	<i>Fee payable half-yearly</i>
(d) exceeding 10 metric tons but not exceeding 15 metric tons	\$300
(e) exceeding 15 metric tons but not exceeding 20 metric tons	\$500
(f) exceeding 20 metric tons but not exceeding 30 metric tons	\$1,000
(g) exceeding 30 metric tons	\$1,500
13. Light and heavy goods vehicles using diesel oil as fuel —	
<i>Maximum laden weight</i>	
(a) not exceeding 3 metric tons	\$500
(b) exceeding 3 metric tons but not exceeding 5 metric tons	\$600
(c) exceeding 5 metric tons but not exceeding 10 metric tons	\$750
(d) exceeding 10 metric tons but not exceeding 15 metric tons	\$1,300
(e) exceeding 15 metric tons but not exceeding 20 metric tons	\$1,300
(f) exceeding 20 metric tons but not exceeding 30 metric tons	\$1,300
(g) exceeding 30 metric tons	\$2,000

Where the light or heavy goods vehicles are registered prior to 11th December 1981 and the fees payable under paragraph 12 or 13 for such vehicles on or after that date exceed the fee (including diesel tax) payable for such vehicles prior to that date (referred to in these Rules as the old fee) by more than \$200 for a year or \$100 for half a year, the fee payable for such vehicles on or after that date shall be subject to a maximum of the total of the old fees and \$200 for a year or the old fees and \$100 for half a year.

SECOND SCHEDULE — *continued*

<i>Description of vehicle</i>	<i>Fee payable half-yearly</i>
14. Goods vehicles used for drawing a trailer. In addition to the fee specified in paragraphs 12 and 13 —	
(a) where the maximum laden weight of the drawing vehicle does not exceed 5 metric tons	\$60
(b) where the maximum laden weight of the drawing vehicle exceeds 5 metric tons but does not exceed 10 metric tons	\$120
(c) where the maximum laden weight of the drawing vehicle exceeds 10 metric tons	\$180
(d) where a vehicle has a trailer attached to it by partial super-imposition, the vehicle and the trailer shall, for the purposes of determining the amount of fee chargeable under this Schedule, be treated as if they together formed a single vehicle	Fee as specified in paragraph 12 or 13, as the case may be
(e) where a trailer of an articulated vehicle is used for container transport and is separately registered as a vehicle	\$60
(f) where a trailer approved by the Registrar is separately registered as a vehicle	\$60

[S 46/2017 wef 15/02/2017]

Notes:

1. For the purposes of computing fees payable under this Schedule, any fraction of a dollar shall be reckoned as one dollar.
2. Monthly licence fee payable shall be computed on pro-rata basis.
3. Annual licence fee payable shall be double the half-yearly licence fee and shall be computed on a pro-rata basis.

SECOND SCHEDULE — *continued*

4. Motor vehicles fitted with engines using heavy oil, diesel oil, electric power or producer gas attachments are chargeable with additional special tax under the Customs Act (Cap. 70).

THIRD SCHEDULE

Rule 14

The index marks for vehicles registered in Singapore shall be as follows:

<i>Type of Vehicles</i>	<i>Index Series</i>
1. Motor cycles and scooters licensed to carry passengers	A, AA to AZ; F, FA to FZ; and FBA to FZZ.
2. Motor cars registered in the names of private individuals or car-sharing co-operatives; motor cars registered in the names of companies, business concerns, professional firms, societies, associations, clubs, etc., with a certificate of entitlement issued on or after 1st April 1998; and private hire cars registered with a certificate of entitlement issued on or after 1st April 1998.	S, SB, SC, SE, SF, SJ to SY; E, EA to EZ; SBA to SBR, SBT to SBZ; SCA, SCE to SCR, SCU to SCZ; SDA, SDB, SDD to SDZ; SFA to SGZ; SJA to SMA, SMC to SSZ; STA, STB, STD, STF to STZ; and SVA to SYZ.
3. Motor cars registered in the names of companies, business concerns, professional firms, societies, associations, clubs, etc., with a certificate of entitlement issued before 1st April 1998	Q, QA to QW, QZ; QEA to QEZ; QBA to QBR, QBT to QBZ; QCA, QCE to QCR, QCU to QCZ; QDA, QDB, QDD to QDZ; QFA to QGZ; QJA to QSY; QTA, QTB, QTD, QTF to QTZ; and QVA to QWZ.
4. Private hire cars registered with a certificate of entitlement issued before 1st April 1998	SZ, SZA to SZZ.

THIRD SCHEDULE — *continued*

<i>Type of Vehicles</i>	<i>Index Series</i>
5. Motor cars registered in the names of the Government and Statutory Boards	QX, QY; QXA to QXZ; and QYA to QYZ.
6. School buses	CB.
7. Consular/Diplomatic Corps vehicles	CC, CD, TC, TE.
8. Private buses, private hire buses and excursion buses registered with a certificate of entitlement issued before 1st April 1998	PB, PH, PZ.
9. Private buses, private hire buses and excursion buses registered with a certificate of entitlement issued on or after 1st April 1998	PA, PC to PG, PJ to PN, PP to PT, PV to PY; and PBA to PZZ.
10. Omnibuses	TIB, SDC, CSS, SBS, SMB, SG.
11. Taxis	SH, SHA to SHZ.
12. Goods vehicles and recovery vehicles having a maximum laden weight not exceeding 3.5 metric tons	G, GA to GZ; and GBA to GZZ.
13. Goods vehicles and recovery vehicles having a maximum laden weight exceeding 3.5 metric tons and constructed with not more than 2 axles	Y, YA to YZ; and YBA to YZZ.
14. Goods vehicles having a maximum laden weight exceeding 3.5 metric tons and constructed with more than 2 axles	X, XA to XZ; and XBA to XZZ.
15. Locomotives and tractors, construction equipment and engineering plant	W, WA to WZ; and WBA to WZZ.
16. Trailers	TR, TRA to TZZ.
17. Motor cycles and scooters (Traffic Police Department)	TP.
18. Land Transport Authority of Singapore's motor cycles and scooters	LTA.

THIRD SCHEDULE — *continued*

<i>Type of Vehicles</i>	<i>Index Series</i>
19. Vehicles registered for use within such areas as may be approved by the Registrar	RU.
20. Pulau Ubin Scheme vehicles	PU.
21. Vehicles kept or used for research and development or for such other purposes as may be approved by the Registrar	RA to RT, RV to RZ.

[S 650/2015 wef 06/11/2015]

Notes:

The above mentioned index marks shall also apply to the following categories of motor vehicles registered before 1st January 1975:

- (a) all goods vehicles;
- (b) motor cars registered in the names of companies, business concerns, professional firms, societies, associations, clubs, etc.; and
- (c) locomotives and tractors, construction equipment and engineering plant.

The Registrar shall assign new identification marks to all motor vehicles so affected.

FOURTH SCHEDULE

Rules 17(2), 18(2) and 64B(4)

DIAGRAM NO. 1

FOURTH SCHEDULE — continued

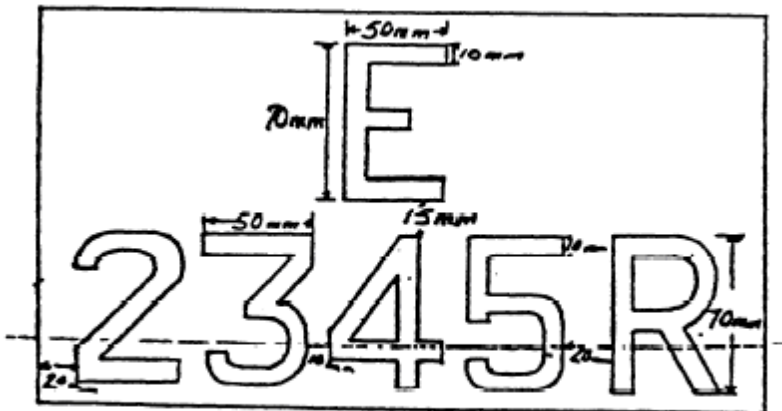

Dimensions are all in mm.

DIAGRAM NO. 2

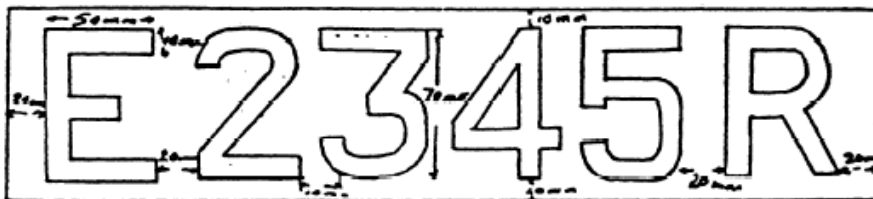

Dimensions are all in mm.

DIAGRAM NO. 3

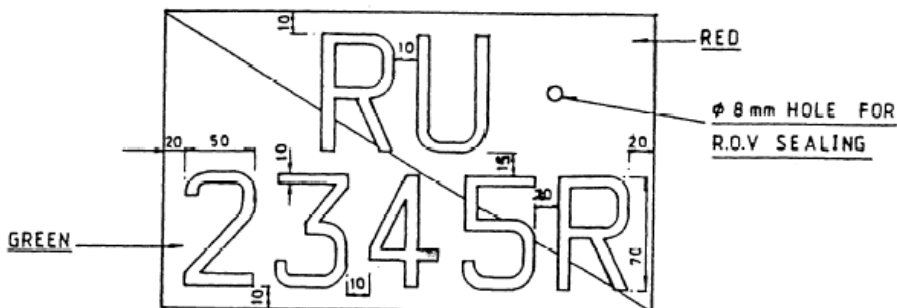

Dimensions are all in mm.

FOURTH SCHEDULE — *continued*

DIAGRAM NO. 4

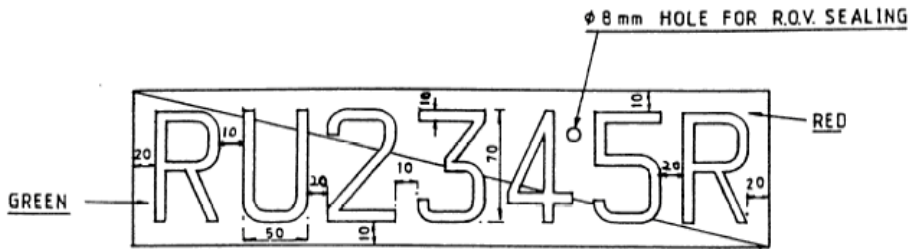

Dimensions are all in mm.

DIAGRAM NO. 5



Dimensions are all in mm.

DIAGRAM NO. 6

FOURTH SCHEDULE — *continued*

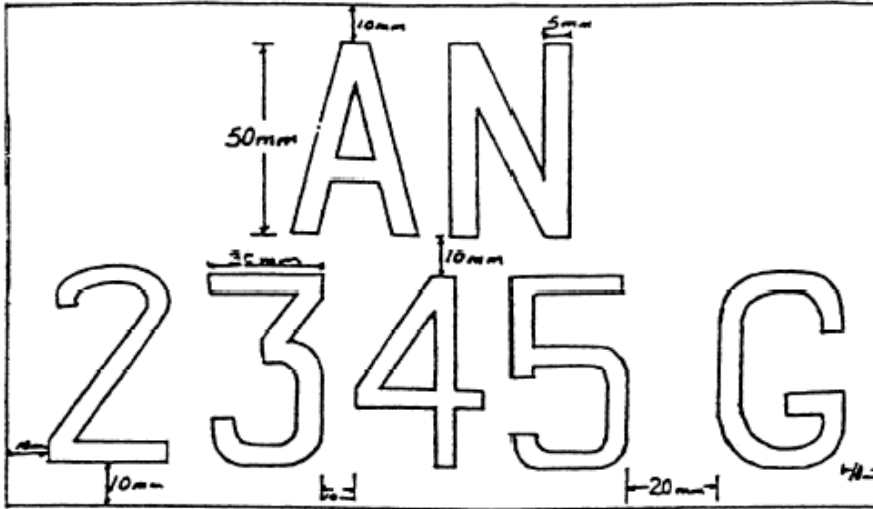

Dimensions are all in mm.

DIAGRAM NO. 7

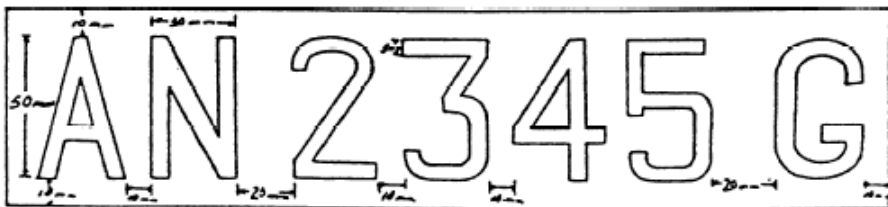

Dimensions are all in mm.

DIAGRAM NO. 8

FOURTH SCHEDULE — continued

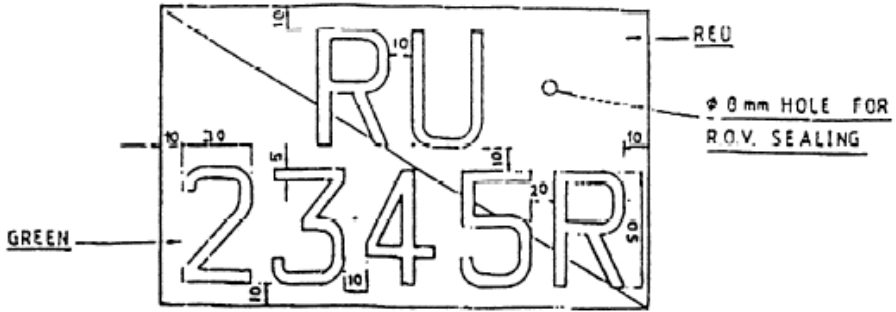

Dimensions are all in mm.

DIAGRAM NO. 9

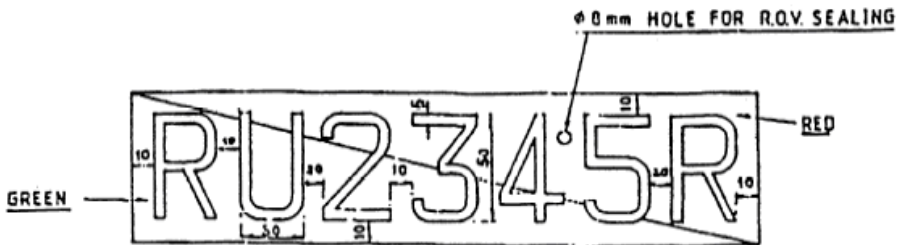

Dimensions are all in mm.

DIAGRAM NO. 10

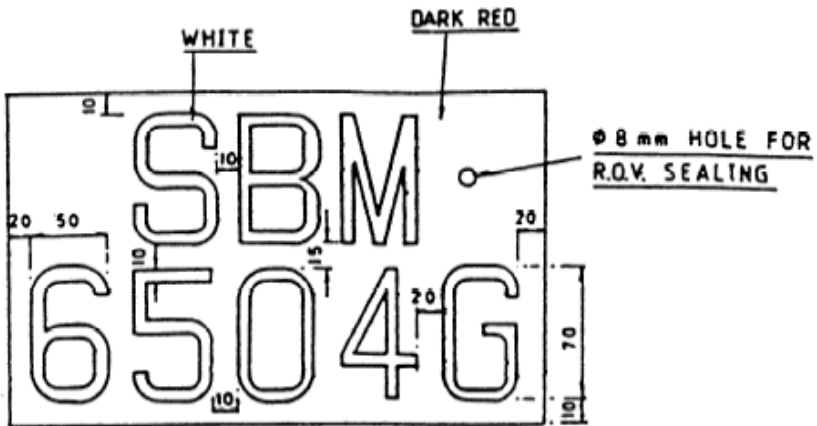

Dimensions are all in mm.

FOURTH SCHEDULE — *continued*

DIAGRAM NO. 11

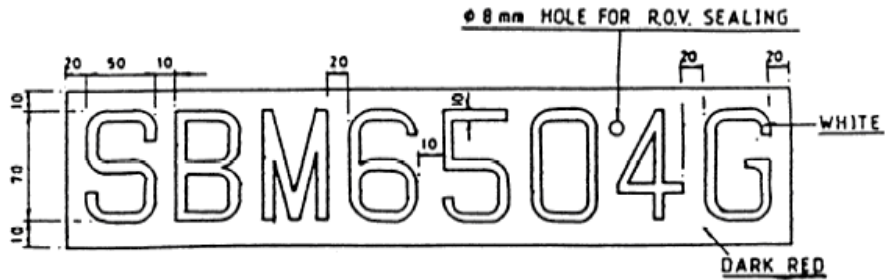

Dimensions are all in mm.

DIAGRAM NO. 12

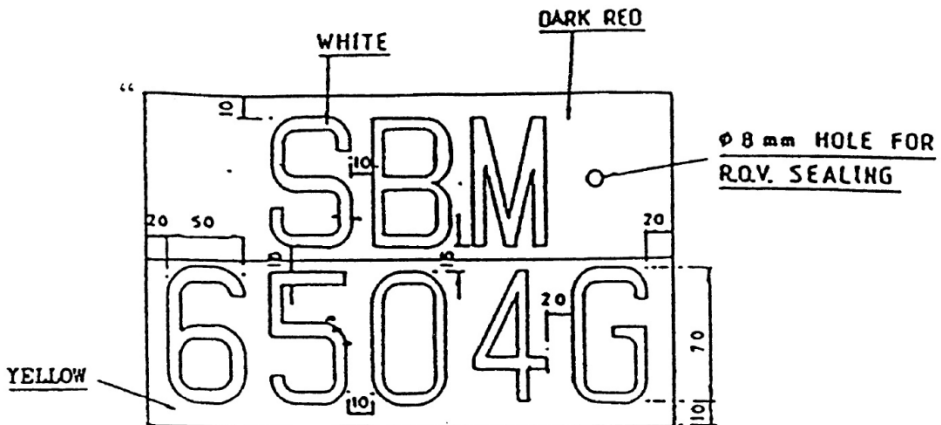

Dimensions are all in mm.

DIAGRAM NO. 13

FOURTH SCHEDULE — continued

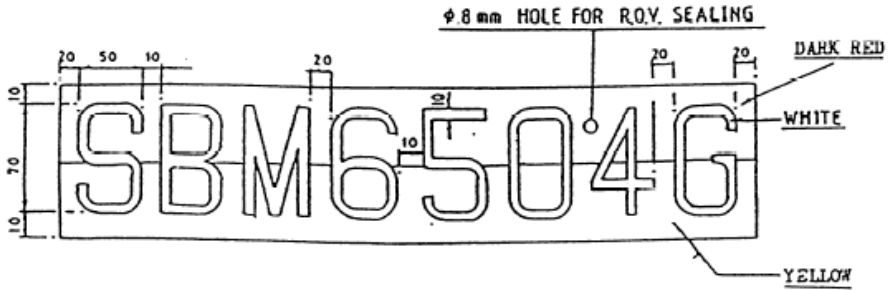

Dimensions are all in mm.

DIAGRAM NO. 14

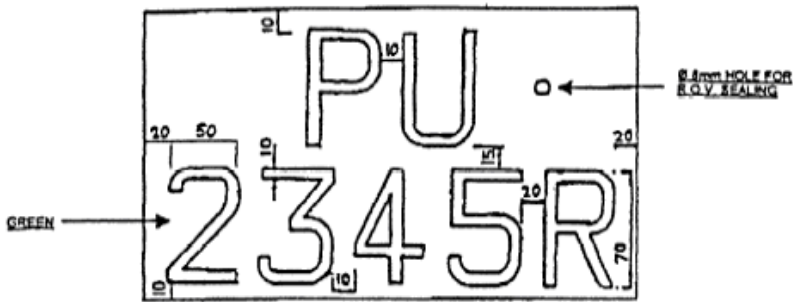

Dimensions are all in mm.

DIAGRAM NO. 15

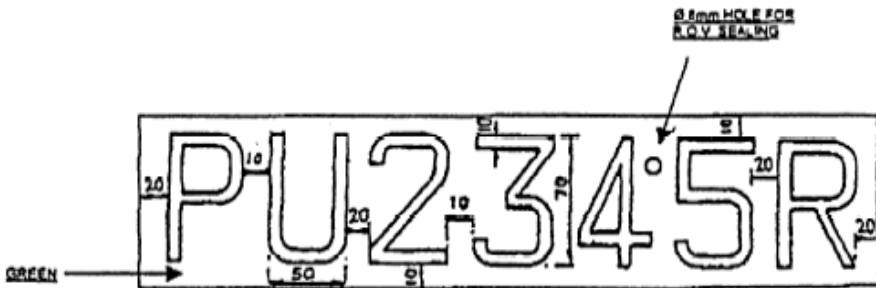

Dimensions are all in mm.

FOURTH SCHEDULE — *continued*

DIAGRAM NO. 16

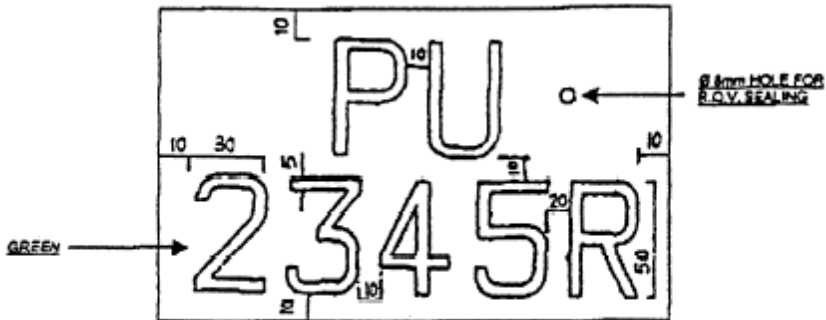

Dimensions are all in mm.

DIAGRAM NO. 17

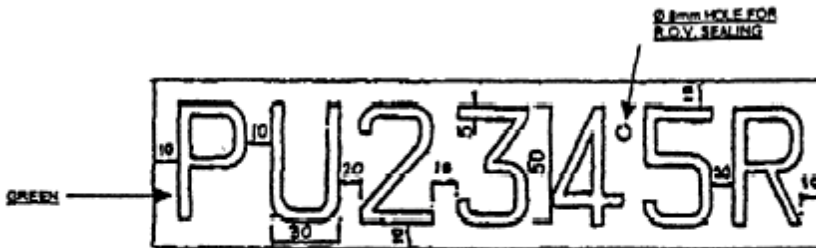

Dimensions are all in mm.

DIAGRAM NO. 18

FOURTH SCHEDULE — continued

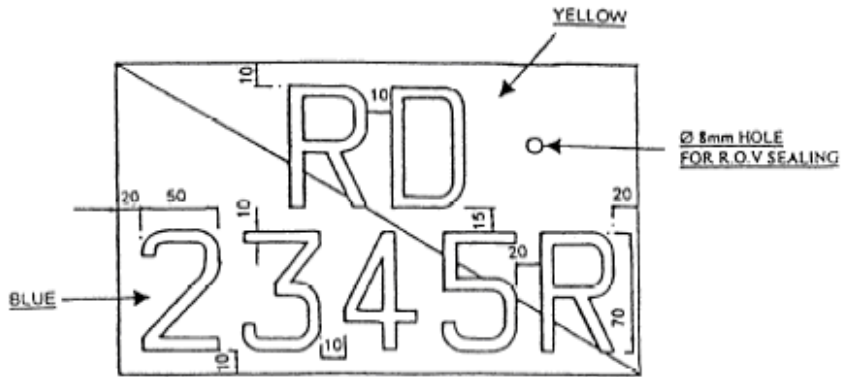

DIAGRAM NO. 19

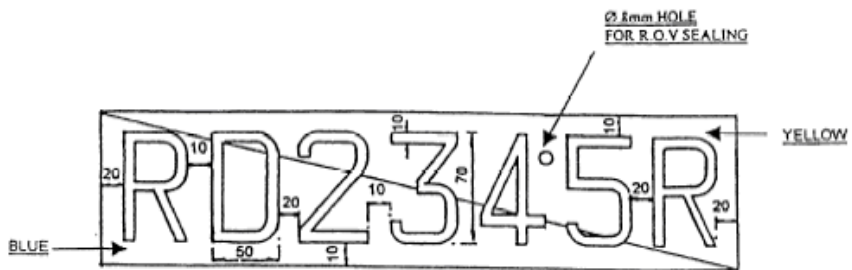
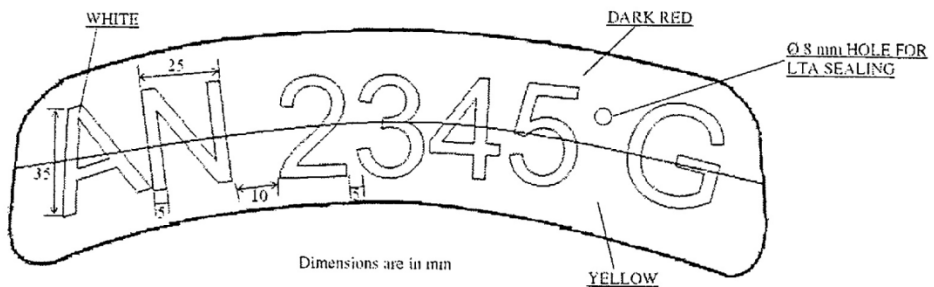

DIAGRAM NO. 20



FOURTH SCHEDULE — *continued*

DIAGRAM NO. 21

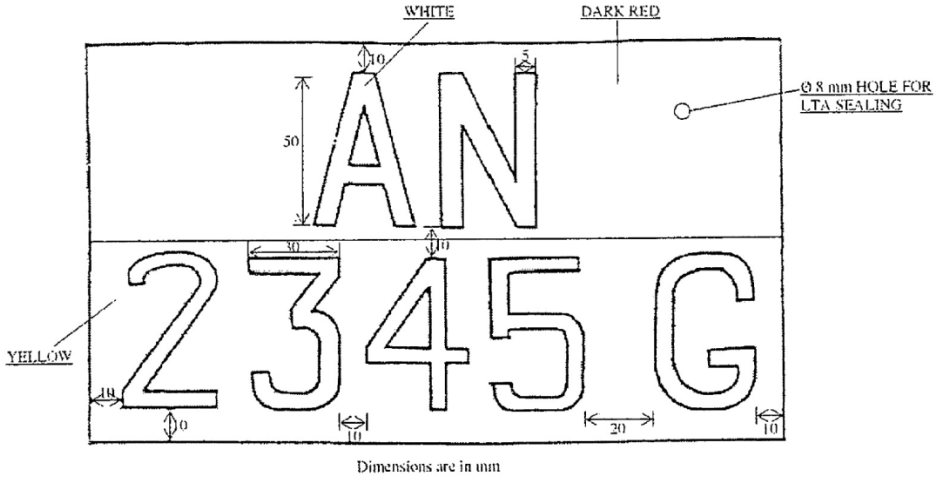
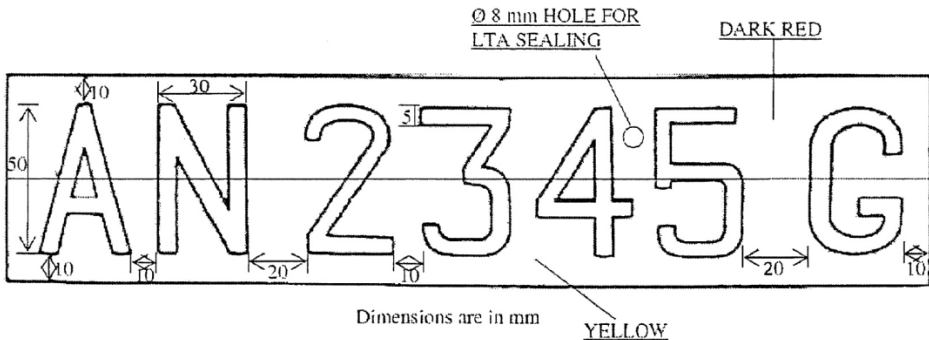

DIAGRAM NO. 22



PROVISIONS TO BE COMPLIED WITH

1. The identification mark comprising the index mark and registration number suffixed with a letter of the alphabet for the vehicle shall be arranged in conformity with the arrangement of letters and figures on one or other of the diagrams.

2.—(1) Unless the identification mark is so constructed that it can be illuminated by means of the transparency or translucency of the letters and figures, or is exhibited on a plate which is constructed of reflex reflecting material in accordance with paragraph 3, it shall be formed of white or silver or light grey

FOURTH SCHEDULE — *continued*

letters and figures upon a black surface and every letter or figure shall be indelibly inscribed upon or so attached to such surface that it cannot easily be detached therefrom.

(2) If the letters and figures are exhibited on a flat plate, the plate may be constructed of cast or pressed metal having raised letters and figures.

(3) If the identification mark is so constructed and used that it is illuminated by transparency or translucency, the letters and figures shall, when so illuminated during the hours of darkness, appear white.

(4) When not so illuminated, the letters and figures shall appear white against a black background.

3. An identification mark may be exhibited on a plate which is constructed of reflex reflecting material and if so exhibited —

(a) the identification mark if displayed on the front of the vehicle shall be formed of black letters and figures against a white background constructed of reflex reflecting material, but no reflecting material shall be applied to any part of the black letters or figures;

(b) the identification mark if displayed on the back of the vehicle or any trailer attached to the vehicle shall be formed of black letters and figures against a yellow background constructed of reflex reflecting material, but no reflecting material shall be applied to any part of the black letters or figures; and

(c) every plate on which the identification mark is exhibited shall be legibly and permanently marked with the specification number of the British Standard for reflex reflecting number plates, namely, B.S. AU. 145: 1967.

4. All letters and figures shall be 70 mm high, every part of every letter and figure shall be 10 mm broad and the total width of the space taken by every letter or figure, except in the case of the figure one, shall be 50 mm.

5. The space between adjoining letters and between adjoining figures shall be 10 mm and there shall be a margin between the nearest part of any letter or figure and the top or bottom of the black surface upon which the identification mark is inscribed of at least 10 mm and between the nearest part of any letter or figure and the sides of the black surface of at least 20 mm.

6.—(1) Where the identification mark is arranged in accordance with Diagram No. 1, the space between the upper and lower line shall be 15 mm and the space between the figures and the last letter shall be 20 mm.

FOURTH SCHEDULE — *continued*

(2) Where the identification mark is arranged in accordance with Diagram No. 2, the space between the letters and the figures shall be 20 mm.

7. In the case of a motor cycle, with or without a side-car attached, as regards the place bearing the identification mark fixed on the front of the motor vehicle, in accordance with the slight curvature of the mudguard, the dimensions prescribed in paragraphs 4, 5 and 6 may be halved as shown in Diagram No. 3; and as regards the plate bearing the identification mark fixed at the rear of the vehicle the following requirements may be complied with in substitution for those prescribed in paragraphs 4, 5 and 6:

- (a) all letters and figures shall be 50 mm high; every part of every letter and figure shall be 10 mm broad; and the total width of the space taken by every letter or figure shall be 30 mm as shown in Diagram No. 4;
- (b) the space between adjoining letters and between adjoining figures shall be 10 mm and there shall be a margin between the nearest part of any letter or figure and the top, bottom and sides of the black surface upon which the identification mark is inscribed of at least 10 mm;
- (c) where the identification mark is arranged in accordance with Diagram No. 4, the space between the upper and lower line shall be 10 mm and the space between the figure and the last letter shall be 20 mm; and
- (d) where the identification mark is arranged in accordance with Diagram No. 5, the space between the letters and the figures shall be 20 mm.

8. The dimension in paragraphs 4, 5 and 6 may be proportionately increased to a maximum of $1\frac{1}{2}$ times the specified sizes.

9. Every plate bearing an identification mark shown in Diagram 8, 9, 10, 11, 12, 13, 14, 15, 17, 18, 19, 20, 21 or 22 shall be sealed in such manner as the Registrar may require.

FIFTH SCHEDULE

Rules 2(1), 38(1) and 55(1) and (3)

RESTRICTED DAYS AND TIMES FOR OFF-PEAK CARS

1. For any off-peak car which is registered on or after 25th January 2010 or any private motor car, business service passenger vehicle or off-peak car which is re-registered as an off-peak car under rule 33E on or after 25th January 2010 — the period from 7 a.m. to 7 p.m. on any day from Monday to Friday, not being a public holiday or the eve of New Year, Lunar New Year, Hari Raya Puasa, Deepavali or Christmas.

FIFTH SCHEDULE — *continued*

2. For any other off-peak car not falling under paragraph 1 —
- (a) the period from 7 a.m. to 7 p.m. on any day from Monday to Friday, not being a public holiday, or the eve of New Year, Lunar New Year, Hari Raya Puasa, Deepavali or Christmas; and
 - (b) the period from 7 a.m. to 3 p.m. on any Saturday, not being a public holiday, or the eve of New Year, Lunar New Year, Hari Raya Puasa, Deepavali or Christmas.

SIXTH SCHEDULE

Rules 36(4) and (8), 36A, 36B, 36C,
36E and 38B(4)

FEES PAYABLE FOR VEHICLE LICENCES COMMENCING ON ANY DATE
BETWEEN 1ST SEPTEMBER 1998 AND 31ST AUGUST 2002 (BOTH DATES
INCLUSIVE)

<i>Description of vehicle</i>	<i>Fee payable half-yearly</i>
1. Motor cars having cylinder capacity (referred to in this Schedule by the letter “E”) —	
(a) not exceeding 600 cubic centimetres	\$250
(b) exceeding 600 cubic centimetres but not exceeding 1,000 cubic centimetres	\$250 + $\frac{0.25(E-600)}{2}$
(c) exceeding 1,000 cubic centimetres but not exceeding 1,600 cubic centimetres	\$300 + $\frac{1.0(E-1,000)}{2}$
(d) exceeding 1,600 cubic centimetres but not exceeding 3,000 cubic centimetres	\$600 + $\frac{1.8(E-1,600)}{2}$
(e) exceeding 3,000 cubic centimetres	\$1,860 + $\frac{2.5(E-3,000)}{2}$
1A. Electric cars having a power rating (referred to in this Schedule by the letter “PR”) —	
(a) not exceeding 7.5 kW	\$250

SIXTH SCHEDULE — *continued*

<i>Description of vehicle</i>	<i>Fee payable half-yearly</i>
(b) exceeding 7.5 kW but not exceeding 27.5 kW	\$250 + $\frac{\$5(\text{PR} - 7.5)}{2}$
(c) exceeding 27.5 kW but not exceeding 57.5 kW	\$300 + $\frac{\$20(\text{PR} - 27.5)}{2}$
(d) exceeding 57.5 kW but not exceeding 127.5 kW	\$600 + $\frac{\$36(\text{PR} - 57.5)}{2}$
(e) exceeding 127.5 kW	\$1,860 + $\frac{\$50(\text{PR} - 127.5)}{2}$
1B. Petrol-electric cars	The higher of the appropriate fee payable under item 1 or 1A based on the petrol-electric car's cylinder capacity or power rating
2. Motor cycles and scooters having cylinder capacity —	
(a) not exceeding 200 cubic centimetres	\$50
(b) exceeding 200 cubic centimetres but not exceeding 1,000 cubic centimetres	\$50 + $\frac{0.4(\text{E} - 200)}{2}$
(c) exceeding 1,000 cubic centimetres	\$210 + $\frac{1.0(\text{E} - 1,000)}{2}$
3. Taxis	\$600
4. Buses constructed for the carriage of passengers not exceeding 30 persons, using diesel as fuel —	
<i>Maximum Laden Weight</i>	
(a) not exceeding 3.5 metric tons	\$450
(b) exceeding 3.5 metric tons but not exceeding 7.0 metric tons	\$460
(c) exceeding 7.0 metric tons but not exceeding 11.0 metric tons	\$500
(d) exceeding 11.0 metric tons but not exceeding 16.0 metric tons	\$650

SIXTH SCHEDULE — *continued*

<i>Description of vehicle</i>	<i>Fee payable half-yearly</i>
5. Buses constructed for the carriage of passengers not exceeding 30 persons, using petroleum as fuel —	
<i>Maximum Laden Weight</i>	
(a) not exceeding 3.5 metric tons	\$360
(b) exceeding 3.5 metric tons but not exceeding 7.0 metric tons	\$368
(c) exceeding 7.0 metric tons but not exceeding 11.0 metric tons	\$400
(d) exceeding 11.0 metric tons but not exceeding 16.0 metric tons	\$520
6. Buses constructed for the carriage of passengers exceeding 30 persons, using diesel as fuel —	
<i>Maximum Laden Weight</i>	
(a) exceeding 3.5 metric tons but not exceeding 7.0 metric tons	\$610
(b) exceeding 7.0 metric tons but not exceeding 11.0 metric tons	\$650
(c) exceeding 11.0 metric tons but not exceeding 16.0 metric tons	\$800
(d) exceeding 16.0 metric tons but not exceeding 20.0 metric tons (with 3 axles)	\$750
(e) exceeding 16.0 metric tons but not exceeding 20.0 metric tons (with 2 axles)	\$1,100
(f) exceeding 20.0 metric tons but not exceeding 26.0 metric tons (with 3 axles)	\$1,000
7. Buses constructed for the carriage of passengers exceeding 30 persons, using petroleum as fuel —	

Maximum Laden Weight

SIXTH SCHEDULE — *continued*

<i>Description of vehicle</i>	<i>Fee payable half-yearly</i>
(a) exceeding 3.5 metric tons but not exceeding 7.0 metric tons	\$488
(b) exceeding 7.0 metric tons but not exceeding 11.0 metric tons	\$520
(c) exceeding 11.0 metric tons but not exceeding 16.0 metric tons	\$640
(d) exceeding 16.0 metric tons but not exceeding 20.0 metric tons (with 3 axles)	\$600
(e) exceeding 16.0 metric tons but not exceeding 20.0 metric tons (with 2 axles)	\$880
(f) exceeding 20.0 metric tons but not exceeding 26.0 metric tons (with 3 axles)	\$800

8. Goods vehicles (excluding prime movers) using diesel as fuel —

Maximum Laden Weight

(a) not exceeding 3.5 metric tons	\$300
(b) exceeding 3.5 metric tons but not exceeding 7.0 metric tons	\$460
(c) exceeding 7.0 metric tons but not exceeding 11.0 metric tons	\$500
(d) exceeding 11.0 metric tons but not exceeding 16.0 metric tons	\$650
(e) exceeding 16.0 metric tons but not exceeding 20.0 metric tons (with 2 axles)	\$1,100
(f) exceeding 16.0 metric tons but not exceeding 20.0 metric tons (with 3 axles)	\$750
(g) exceeding 20.0 metric tons but not exceeding 26.0 metric tons	\$1,000

SIXTH SCHEDULE — *continued*

<i>Description of vehicle</i>	<i>Fee payable half-yearly</i>
(h) exceeding 26.0 metric tons but not exceeding 32.0 metric tons	\$1,000
(i) exceeding 32.0 metric tons but not exceeding 40.0 metric tons (with 4 axles)	\$1,500
(j) exceeding 32.0 metric tons but not exceeding 40.0 metric tons (with 5 or more axles)	\$1,100
(k) exceeding 40.0 metric tons but not exceeding 55.0 metric tons	\$1,600
(l) exceeding 55.0 metric tons	\$1,850
9. Goods vehicles (excluding prime movers) using petroleum as fuel —	
<i>Maximum Laden Weight</i>	
(a) not exceeding 3.5 metric tons	\$240
(b) exceeding 3.5 metric tons but not exceeding 7.0 metric tons	\$368
(c) exceeding 7.0 metric tons but not exceeding 11.0 metric tons	\$400
(d) exceeding 11.0 metric tons but not exceeding 16.0 metric tons	\$520
(e) exceeding 16.0 metric tons but not exceeding 20.0 metric tons (with 2 axles)	\$880
(f) exceeding 16.0 metric tons but not exceeding 20.0 metric tons (with 3 axles)	\$600
(g) exceeding 20.0 metric tons but not exceeding 26.0 metric tons	\$800
(h) exceeding 26.0 metric tons but not exceeding 32.0 metric tons	\$800
(i) exceeding 32.0 metric tons but not exceeding 40.0 metric tons (with 4 axles)	\$1,200

SIXTH SCHEDULE — *continued*

<i>Description of vehicle</i>	<i>Fee payable half-yearly</i>
(j) exceeding 32.0 metric tons but not exceeding 40.0 metric tons (with 5 or more axles)	\$880
(k) exceeding 40.0 metric tons but not exceeding 55.0 metric tons	\$1,280
(l) exceeding 55.0 metric tons	\$1,480
10. Prime movers using diesel as fuel —	
<i>Maximum Laden Weight</i>	
(a) not exceeding 20.0 metric tons	\$750
(b) exceeding 20.0 metric tons but not exceeding 26.0 metric tons	\$1,000
(c) exceeding 26.0 metric tons but not exceeding 32.0 metric tons	\$1,000
(d) exceeding 32.0 metric tons but not exceeding 40.0 metric tons	\$1,100
(e) exceeding 40.0 metric tons but not exceeding 55.0 metric tons	\$1,600
(f) exceeding 55.0 metric tons	\$1,850
11. Goods-cum-passengers vehicles using diesel as fuel —	
<i>Maximum Laden Weight</i>	
(a) not exceeding 3.5 metric tons	\$600
(b) exceeding 3.5 metric tons	\$760
12. Goods-cum-passengers vehicles using petroleum as fuel —	
<i>Maximum Laden Weight</i>	
(a) not exceeding 3.5 metric tons	\$480
(b) exceeding 3.5 metric tons	\$608
13. Trailers	\$60

SIXTH SCHEDULE — *continued*

Notes:

1. For the purposes of computing fees payable under this Schedule, any fraction of a dollar shall be reckoned as one dollar.
2. Monthly licence fee payable shall be computed on a pro-rata basis.
3. Annual licence fee payable shall be double the half-yearly licence fee and shall be computed on a pro-rata basis.
4. Motor vehicles fitted with engines using heavy oil, diesel oil, electric power or producer gas attachments are chargeable with additional special tax under the Customs Act (Cap. 70).

SEVENTH SCHEDULE

Rule 38B(3)

FEE PAYABLE FOR PU-REGISTERED VEHICLES

<i>Description of vehicle</i>	<i>Fee payable yearly</i>
1. Motor cycles and scooters	\$25
2. Any other motor vehicles	\$50

EIGHTH SCHEDULE

[Deleted by S 144/2012]

NINTH SCHEDULE

Rules 36(4) and (8), 36A, 36B(1), 36E
and 38B(4)

FEES PAYABLE FOR VEHICLE LICENCES COMMENCING ON ANY DATE
BETWEEN 1ST SEPTEMBER 2002 AND 31ST AUGUST 2007 (BOTH DATES
INCLUSIVE) OTHER THAN VEHICLE LICENCES TO WHICH RULE 36C
APPLIES

<i>Description of vehicle</i>	<i>Fee payable half-yearly</i>
1. Motor cars having cylinder capacity (referred to in this Schedule by the letter “E”) —	
(a) not exceeding 600 cubic centimetres	\$200

NINTH SCHEDULE — *continued*

<i>Description of vehicle</i>	<i>Fee payable half-yearly</i>
(b) exceeding 600 cubic centimetres but not exceeding 1,000 cubic centimetres	\$200 + $\frac{0.25 (E - 600)}{2}$
(c) exceeding 1,000 cubic centimetres but not exceeding 1,600 cubic centimetres	\$250 + $\frac{0.75 (E - 1,000)}{2}$
(d) exceeding 1,600 cubic centimetres but not exceeding 3,000 cubic centimetres	\$475 + $\frac{1.5 (E - 1,600)}{2}$
(e) exceeding 3,000 cubic centimetres	\$1,525 + $\frac{2.0 (E - 3,000)}{2}$
2. Electric cars having a power rating (referred to in this Schedule by the letters “PR”) —	
(a) not exceeding 7.5 kW	\$200
(b) exceeding 7.5 kW but not exceeding 27.5 kW	\$200 + $\frac{\$5 (PR - 7.5)}{2}$
(c) exceeding 27.5 kW but not exceeding 57.5 kW	\$250 + $\frac{\$15 (PR - 27.5)}{2}$
(d) exceeding 57.5 kW but not exceeding 127.5 kW	\$475 + $\frac{\$30 (PR - 57.5)}{2}$
(e) exceeding 127.5 kW	\$1,525 + $\frac{\$40 (PR - 127.5)}{2}$
3. Petrol-electric cars	The higher of the appropriate fee payable under item 1 or 2 based on the petrol-electric car’s cylinder capacity or power rating.
4. Motor cycles and scooters having cylinder capacity —	
(a) not exceeding 200 cubic centimetres	\$40
(b) exceeding 200 cubic centimetres but not exceeding 1,000 cubic centimetres	\$40 + $\frac{0.3 (E - 200)}{2}$

NINTH SCHEDULE — *continued*

<i>Description of vehicle</i>	<i>Fee payable half-yearly</i>
(c) exceeding 1,000 cubic centimetres	\$160 + $\frac{0.6(E - 1,000)}{2}$
5. Taxis	\$600
6. Buses constructed for the carriage of passengers not exceeding 30 persons, using diesel as fuel —	
<i>Maximum Laden Weight</i>	
(a) not exceeding 3.5 metric tons	\$375
(b) exceeding 3.5 metric tons but not exceeding 7.0 metric tons	\$385
(c) exceeding 7.0 metric tons but not exceeding 11.0 metric tons	\$425
(d) exceeding 11.0 metric tons but not exceeding 16.0 metric tons	\$575
7. Buses constructed for the carriage of passengers not exceeding 30 persons, using petroleum as fuel —	
<i>Maximum Laden Weight</i>	
(a) not exceeding 3.5 metric tons	\$300
(b) exceeding 3.5 metric tons but not exceeding 7.0 metric tons	\$308
(c) exceeding 7.0 metric tons but not exceeding 11.0 metric tons	\$340
(d) exceeding 11.0 metric tons but not exceeding 16.0 metric tons	\$460
8. Buses constructed for the carriage of passengers exceeding 30 persons, using diesel as fuel —	
<i>Maximum Laden Weight</i>	

NINTH SCHEDULE — *continued*

<i>Description of vehicle</i>	<i>Fee payable half-yearly</i>
(a) exceeding 3.5 metric tons but not exceeding 7.0 metric tons	\$510
(b) exceeding 7.0 metric tons but not exceeding 11.0 metric tons	\$550
(c) exceeding 11.0 metric tons but not exceeding 16.0 metric tons	\$700
(d) exceeding 16.0 metric tons but not exceeding 20.0 metric tons (with 3 axles)	\$650
(e) exceeding 16.0 metric tons but not exceeding 20.0 metric tons (with 2 axles)	\$1,000
(f) exceeding 20.0 metric tons but not exceeding 26.0 metric tons (with 3 axles)	\$900
9. Buses constructed for the carriage of passengers exceeding 30 persons, using petroleum as fuel —	
<i>Maximum Laden Weight</i>	
(a) exceeding 3.5 metric tons but not exceeding 7.0 metric tons	\$408
(b) exceeding 7.0 metric tons but not exceeding 11.0 metric tons	\$440
(c) exceeding 11.0 metric tons but not exceeding 16.0 metric tons	\$560
(d) exceeding 16.0 metric tons but not exceeding 20.0 metric tons (with 3 axles)	\$520

NINTH SCHEDULE — *continued*

<i>Description of vehicle</i>	<i>Fee payable half-yearly</i>
(e) exceeding 16.0 metric tons but not exceeding 20.0 metric tons (with 2 axles)	\$800
(f) exceeding 20.0 metric tons but not exceeding 26.0 metric tons (with 3 axles)	\$720
10. Goods vehicles (excluding prime movers) using diesel as fuel —	
<i>Maximum Laden Weight</i>	
(a) not exceeding 3.5 metric tons	\$250
(b) exceeding 3.5 metric tons but not exceeding 7.0 metric tons	\$385
(c) exceeding 7.0 metric tons but not exceeding 11.0 metric tons	\$425
(d) exceeding 11.0 metric tons but not exceeding 16.0 metric tons	\$575
(e) exceeding 16.0 metric tons but not exceeding 20.0 metric tons (with 2 axles)	\$1,000
(f) exceeding 16.0 metric tons but not exceeding 20.0 metric tons (with 3 axles)	\$650
(g) exceeding 20.0 metric tons but not exceeding 26.0 metric tons	\$900
(h) exceeding 26.0 metric tons but not exceeding 32.0 metric tons	\$900
(i) exceeding 32.0 metric tons but not exceeding 40.0 metric tons (with 4 axles)	\$1,400

NINTH SCHEDULE — *continued*

<i>Description of vehicle</i>	<i>Fee payable half-yearly</i>
(j) exceeding 32.0 metric tons but not exceeding 40.0 metric tons (with 5 or more axles)	\$1,000
(k) exceeding 40.0 metric tons but not exceeding 55.0 metric tons	\$1,500
(l) exceeding 55.0 metric tons	\$1,750
11. Goods vehicles (excluding prime movers) using petroleum as fuel —	
<i>Maximum Laden Weight</i>	
(a) not exceeding 3.5 metric tons	\$200
(b) exceeding 3.5 metric tons but not exceeding 7.0 metric tons	\$308
(c) exceeding 7.0 metric tons but not exceeding 11.0 metric tons	\$340
(d) exceeding 11.0 metric tons but not exceeding 16.0 metric tons	\$460
(e) exceeding 16.0 metric tons but not exceeding 20.0 metric tons (with 2 axles)	\$800
(f) exceeding 16.0 metric tons but not exceeding 20.0 metric tons (with 3 axles)	\$520
(g) exceeding 20.0 metric tons but not exceeding 26.0 metric tons	\$720
(h) exceeding 26.0 metric tons but not exceeding 32.0 metric tons	\$720
(i) exceeding 32.0 metric tons but not exceeding 40.0 metric tons (with 4 axles)	\$1,120

NINTH SCHEDULE — *continued*

<i>Description of vehicle</i>	<i>Fee payable half-yearly</i>
(j) exceeding 32.0 metric tons but not exceeding 40.0 metric tons (with 5 or more axles)	\$800
(k) exceeding 40.0 metric tons but not exceeding 55.0 metric tons	\$1,200
(l) exceeding 55.0 metric tons	\$1,400
12. Prime movers using diesel as fuel —	
<i>Maximum Laden Weight</i>	
(a) not exceeding 20.0 metric tons	\$650
(b) exceeding 20.0 metric tons but not exceeding 26.0 metric tons	\$900
(c) exceeding 26.0 metric tons but not exceeding 32.0 metric tons	\$900
(d) exceeding 32.0 metric tons but not exceeding 40.0 metric tons	\$1,000
(e) exceeding 40.0 metric tons but not exceeding 55.0 metric tons	\$1,500
(f) exceeding 55.0 metric tons	\$1,750
13. Goods-cum-passengers vehicles using diesel as fuel —	
<i>Maximum Laden Weight</i>	
(a) not exceeding 3.5 metric tons	\$475
(b) exceeding 3.5 metric tons	\$610
14. Goods-cum-passengers vehicles using petroleum as fuel —	
<i>Maximum Laden Weight</i>	

NINTH SCHEDULE — *continued*

<i>Description of vehicle</i>	<i>Fee payable half-yearly</i>
(a) not exceeding 3.5 metric tons	\$380
(b) exceeding 3.5 metric tons	\$488
15. Trailers	\$60

Notes:

1. For the purposes of computing fees payable under this Schedule, any fraction of a dollar shall be reckoned as one dollar.
2. Monthly licence fee payable shall be computed on a pro-rata basis.
3. Annual licence fee payable shall be double the half-yearly licence fee and shall be computed on a pro-rata basis.
4. Motor vehicles fitted with engines using heavy oil, diesel oil, electric power or producer gas attachments are chargeable with additional special tax under the Customs Act (Cap. 70).

TENTH SCHEDULE

Rule 36C

FEES PAYABLE FOR VEHICLE LICENCES FOR BUSES, GOODS VEHICLES AND GOODS-CUM-PASSENGERS VEHICLES WHICH ARE CNG VEHICLES, PETROL-CNG VEHICLES, ELECTRIC VEHICLES OR PETROL-ELECTRIC VEHICLES COMMENCING ON ANY DATE BETWEEN 1ST JANUARY 2006 AND 30TH JUNE 2008 (BOTH DATES INCLUSIVE)

<i>Description of vehicle</i>	<i>Fee payable per half-yearly</i>
1. Buses which are CNG vehicles, petrol-CNG vehicles, electric vehicles or petrol-electric vehicles and constructed for the carriage of passengers not exceeding 30 persons —	
<i>Maximum Laden Weight</i>	
(a) not exceeding 3.5 metric tons	\$300
(b) exceeding 3.5 metric tons but not exceeding 7.0 metric tons	\$308

TENTH SCHEDULE — *continued*

<i>Description of vehicle</i>	<i>Fee payable per half-yearly</i>
(c) exceeding 7.0 metric tons but not exceeding 11.0 metric tons	\$340
(d) exceeding 11.0 metric tons but not exceeding 16.0 metric tons	\$460
2. Buses which are CNG vehicles, petrol-CNG vehicles, electric vehicles or petrol-electric vehicles and constructed for the carriage of passengers exceeding 30 persons —	
<i>Maximum Laden Weight</i>	
(a) exceeding 3.5 metric tons but not exceeding 7.0 metric tons	\$408
(b) exceeding 7.0 metric tons but not exceeding 11.0 metric tons	\$440
(c) exceeding 11.0 metric tons but not exceeding 16.0 metric tons	\$560
(d) exceeding 16.0 metric tons but not exceeding 20.0 metric tons (with 3 axles)	\$520
(e) exceeding 16.0 metric tons but not exceeding 20.0 metric tons (with 2 axles)	\$800
(f) exceeding 20.0 metric tons but not exceeding 26.0 metric tons (with 3 axles)	\$720
3. Goods vehicles (excluding prime movers and goods-cum-passengers vehicles) which are CNG vehicles, petrol-CNG vehicles, electric vehicles or petrol-electric vehicles —	
<i>Maximum Laden Weight</i>	
(a) not exceeding 3.5 metric tons	\$200
(b) exceeding 3.5 metric tons but not exceeding 7.0 metric tons	\$308

TENTH SCHEDULE — *continued*

<i>Description of vehicle</i>	<i>Fee payable per half-yearly</i>
(c) exceeding 7.0 metric tons but not exceeding 11.0 metric tons	\$340
(d) exceeding 11.0 metric tons but not exceeding 16.0 metric tons	\$460
(e) exceeding 16.0 metric tons but not exceeding 20.0 metric tons (with 2 axles)	\$800
(f) exceeding 16.0 metric tons but not exceeding 20.0 metric tons (with 3 axles)	\$520
(g) exceeding 20.0 metric tons but not exceeding 26.0 metric tons	\$720
(h) exceeding 26.0 metric tons but not exceeding 32.0 metric tons	\$720
(i) exceeding 32.0 metric tons but not exceeding 40.0 metric tons (with 4 axles)	\$1,120
(j) exceeding 32.0 metric tons but not exceeding 40.0 metric tons (with 5 or more axles)	\$800
(k) exceeding 40.0 metric tons but not exceeding 55.0 metric tons	\$1,200
(l) exceeding 55.0 metric tons	\$1,400

4. Goods-cum-passengers vehicles which are CNG vehicles, petrol-CNG vehicles, electric vehicles or petrol-electric vehicles —

Maximum Laden Weight

(a) not exceeding 3.5 metric tons	\$380
(b) exceeding 3.5 metric tons	\$488

Notes:

1. For the purposes of computing fees payable under this Schedule, any fraction of a dollar shall be reckoned as one dollar.

TENTH SCHEDULE — *continued*

2. Monthly licence fee payable shall be computed on a pro-rata basis.
3. Annual licence fee payable shall be double the half-yearly licence fee and shall be computed on a pro-rata basis.

ELEVENTH SCHEDULE

Rules 36(4) and (8), 36A, 36B, 36E and
38B(4)

FEES PAYABLE FOR VEHICLE LICENCES COMMENCING
ON ANY DATE BETWEEN 1ST SEPTEMBER 2007 AND 30TH JUNE 2008
(BOTH DATES INCLUSIVE) OTHER THAN
VEHICLE LICENCES TO WHICH RULE 36C APPLIES

<i>Description of vehicle</i>	<i>Fee payable half-yearly</i>
1. Motor cars having cylinder capacity (referred to in this Schedule by the letter “E”) —	
(a) not exceeding 600 cubic centimetres	$\$200 \times 0.92$
(b) exceeding 600 cubic centimetres but not exceeding 1,000 cubic centimetres	$[\$200 + \frac{0.25(E-600)}{2}] \times 0.92$
(c) exceeding 1,000 cubic centimetres but not exceeding 1,600 cubic centimetres	$[\$250 + \frac{0.75(E-1,000)}{2}] \times 0.92$
(d) exceeding 1,600 cubic centimetres but not exceeding 3,000 cubic centimetres	$[\$475 + \frac{1.5(E-1,600)}{2}] \times 0.92$
(e) exceeding 3,000 cubic centimetres	$[\$1,525 + \frac{2.0(E-3,000)}{2}] \times 0.92$
2. Electric cars having a power rating (referred to in this Schedule by the letters “PR”) —	
(a) not exceeding 7.5 kW	$\$200 \times 0.92$

ELEVENTH SCHEDULE — *continued*

<i>Description of vehicle</i>	<i>Fee payable half-yearly</i>
(b) exceeding 7.5 kW but not exceeding 27.5 kW	$[\$200 + \frac{\$5(\text{PR} - 7.5)}{2}] \times 0.92$
(c) exceeding 27.5 kW but not exceeding 57.5 kW	$[\$250 + \frac{\$15(\text{PR} - 27.5)}{2}] \times 0.92$
(d) exceeding 57.5 kW but not exceeding 127.5 kW	$[\$475 + \frac{\$30(\text{PR} - 57.5)}{2}] \times 0.92$
(e) exceeding 127.5 kW	$[\$1,525 + \frac{\$40(\text{PR} - 127.5)}{2}] \times 0.92$
3. Petrol-electric cars	The higher of the appropriate fee payable under item 1 or 2 based on the petrol-electric car's cylinder capacity or power rating
4. Motor cycles and scooters having cylinder capacity —	
(a) not exceeding 200 cubic centimetres	$\$40 \times 0.92$
(b) exceeding 200 cubic centimetres but not exceeding 1,000 cubic centimetres	$[\$40 + \frac{0.3(\text{E} - 200)}{2}] \times 0.92$
(c) exceeding 1,000 cubic centimetres	$[\$160 + \frac{0.6(\text{E} - 1,000)}{2}] \times 0.92$
5. Taxis	\$600
6. Buses constructed for the carriage of passengers not exceeding 30 persons, using diesel as fuel —	
<i>Maximum Laden Weight</i>	
(a) not exceeding 3.5 metric tons	\$375
(b) exceeding 3.5 metric tons but not exceeding 7.0 metric tons	\$385

ELEVENTH SCHEDULE — *continued*

<i>Description of vehicle</i>	<i>Fee payable half-yearly</i>
(c) exceeding 7.0 metric tons but not exceeding 11.0 metric tons	\$425
(d) exceeding 11.0 metric tons but not exceeding 16.0 metric tons	\$575
7. Buses constructed for the carriage of passengers not exceeding 30 persons, using petroleum as fuel —	
<i>Maximum Laden Weight</i>	
(a) not exceeding 3.5 metric tons	\$300
(b) exceeding 3.5 metric tons but not exceeding 7.0 metric tons	\$308
(c) exceeding 7.0 metric tons but not exceeding 11.0 metric tons	\$340
(d) exceeding 11.0 metric tons but not exceeding 16.0 metric tons	\$460
8. Buses constructed for the carriage of passengers exceeding 30 persons, using diesel as fuel —	
<i>Maximum Laden Weight</i>	
(a) exceeding 3.5 metric tons but not exceeding 7.0 metric tons	\$510
(b) exceeding 7.0 metric tons but not exceeding 11.0 metric tons	\$550

ELEVENTH SCHEDULE — *continued*

<i>Description of vehicle</i>	<i>Fee payable half-yearly</i>
(c) exceeding 11.0 metric tons but not exceeding 16.0 metric tons	\$700
(d) exceeding 16.0 metric tons but not exceeding 20.0 metric tons (with 3 axles)	\$650
(e) exceeding 16.0 metric tons but not exceeding 20.0 metric tons (with 2 axles)	\$1,000
(f) exceeding 20.0 metric tons but not exceeding 26.0 metric tons (with 3 axles)	\$900
9. Buses constructed for the carriage of passengers exceeding 30 persons, using petroleum as fuel —	
<i>Maximum Laden Weight</i>	
(a) exceeding 3.5 metric tons but not exceeding 7.0 metric tons	\$408
(b) exceeding 7.0 metric tons but not exceeding 11.0 metric tons	\$440
(c) exceeding 11.0 metric tons but not exceeding 16.0 metric tons	\$560
(d) exceeding 16.0 metric tons but not exceeding 20.0 metric tons (with 3 axles)	\$520
(e) exceeding 16.0 metric tons but not exceeding	\$800

ELEVENTH SCHEDULE — *continued*

<i>Description of vehicle</i>	<i>Fee payable half-yearly</i>
20.0 metric tons (with 2 axles)	
(f) exceeding 20.0 metric tons but not exceeding 26.0 metric tons (with 3 axles)	\$720
10. Goods vehicles (excluding prime movers) using diesel as fuel —	
<i>Maximum Laden Weight</i>	
(a) not exceeding 3.5 metric tons	\$250
(b) exceeding 3.5 metric tons but not exceeding 7.0 metric tons	\$385
(c) exceeding 7.0 metric tons but not exceeding 11.0 metric tons	\$425
(d) exceeding 11.0 metric tons but not exceeding 16.0 metric tons	\$575
(e) exceeding 16.0 metric tons but not exceeding 20.0 metric tons (with 2 axles)	\$1,000
(f) exceeding 16.0 metric tons but not exceeding 20.0 metric tons (with 3 axles)	\$650
(g) exceeding 20.0 metric tons but not exceeding 26.0 metric tons	\$900
(h) exceeding 26.0 metric tons but not exceeding 32.0 metric tons	\$900

ELEVENTH SCHEDULE — *continued*

<i>Description of vehicle</i>	<i>Fee payable half-yearly</i>
(i) exceeding 32.0 metric tons but not exceeding 40.0 metric tons (with 4 axles)	\$1,400
(j) exceeding 32.0 metric tons but not exceeding 40.0 metric tons (with 5 or more axles)	\$1,000
(k) exceeding 40.0 metric tons but not exceeding 55.0 metric tons	\$1,500
(l) exceeding 55.0 metric tons	\$1,750
11. Goods vehicles (excluding prime movers) using petroleum as fuel —	
<i>Maximum Laden Weight</i>	
(a) not exceeding 3.5 metric tons	\$200
(b) exceeding 3.5 metric tons but not exceeding 7.0 metric tons	\$308
(c) exceeding 7.0 metric tons but not exceeding 11.0 metric tons	\$340
(d) exceeding 11.0 metric tons but not exceeding 16.0 metric tons	\$460
(e) exceeding 16.0 metric tons but not exceeding 20.0 metric tons (with 2 axles)	\$800
(f) exceeding 16.0 metric tons but not exceeding	\$520

ELEVENTH SCHEDULE — *continued*

<i>Description of vehicle</i>	<i>Fee payable half-yearly</i>
20.0 metric tons (with 3 axles)	
(g) exceeding 20.0 metric tons but not exceeding 26.0 metric tons	\$720
(h) exceeding 26.0 metric tons but not exceeding 32.0 metric tons	\$720
(i) exceeding 32.0 metric tons but not exceeding 40.0 metric tons (with 4 axles)	\$1,120
(j) exceeding 32.0 metric tons but not exceeding 40.0 metric tons (with 5 or more axles)	\$800
(k) exceeding 40.0 metric tons but not exceeding 55.0 metric tons	\$1,200
(l) exceeding 55.0 metric tons	\$1,400
12. Prime movers using diesel as fuel —	
<i>Maximum Laden Weight</i>	
(a) not exceeding 20.0 metric tons	\$650
(b) exceeding 20.0 metric tons but not exceeding 26.0 metric tons	\$900
(c) exceeding 26.0 metric tons but not exceeding 32.0 metric tons	\$900
(d) exceeding 32.0 metric tons but not exceeding 40.0 metric tons	\$1,000

ELEVENTH SCHEDULE — *continued*

<i>Description of vehicle</i>	<i>Fee payable half-yearly</i>
(e) exceeding 40.0 metric tons but not exceeding 55.0 metric tons	\$1,500
(f) exceeding 55.0 metric tons	\$1,750
13. Goods-cum-passengers vehicles using diesel as fuel —	
<i>Maximum Laden Weight</i>	
(a) not exceeding 3.5 metric tons	\$437
(b) exceeding 3.5 metric tons	\$572
14. Goods-cum-passengers vehicles using petroleum as fuel —	
<i>Maximum Laden Weight</i>	
(a) not exceeding 3.5 metric tons	\$350
(b) exceeding 3.5 metric tons	\$458
15. Trailers	\$60

Notes:

1. For the purposes of computing fees payable under this Schedule, any fraction of a dollar shall be reckoned as one dollar.
2. Monthly licence fee payable shall be computed on a pro-rata basis.
3. Annual licence fee payable shall be double the half-yearly licence fee and shall be computed on a pro-rata basis.
4. Motor vehicles equipped with engines using heavy oil, diesel oil, liquefied petroleum gas, natural gas or any other gas as fuel or fitted with producer gas or other gas attachments are chargeable with additional special tax under the Customs Act (Cap. 70).

TWELFTH SCHEDULE

Rules 36(4), (4B) and (8), 36A, 36B,
36C, 36D, 36E and 38B(4)

FEES PAYABLE FOR VEHICLE LICENCES
COMMENCING ON OR AFTER 1ST JULY 2008

<i>Description of vehicle</i>	<i>Fee payable half-yearly</i>
1. Motor cars having cylinder capacity (referred to in this Schedule by the letter “E”) —	
(a) not exceeding 600 cubic centimetres	\$200 × 0.782
(b) exceeding 600 cubic centimetres but not exceeding 1,000 cubic centimetres	[\$200 + \$0.125 (E – 600)] × 0.782
(c) exceeding 1,000 cubic centimetres but not exceeding 1,600 cubic centimetres	[\$250 + \$0.375 (E – 1,000)] × 0.782
(d) exceeding 1,600 cubic centimetres but not exceeding 3,000 cubic centimetres	[\$475 + \$0.75 (E – 1,600)] × 0.782
(e) exceeding 3,000 cubic centimetres	[\$1,525 + \$1 (E – 3,000)] × 0.782
2. Electric cars having a power rating (referred to in this Schedule by the letters “PR”) —	
(a) not exceeding 7.5 kW	\$200 × 0.782

TWELFTH SCHEDULE — *continued*

<i>Description of vehicle</i>	<i>Fee payable half-yearly</i>
(b) exceeding 7.5 kW but not exceeding 32.5 kW	$[\$200 + \$2 (\text{PR} - 7.5)] \times 0.782$
(c) exceeding 32.5 kW but not exceeding 70 kW	$[\$250 + \$6 (\text{PR} - 32.5)] \times 0.782$
(d) exceeding 70 kW but not exceeding 157.5 kW	$[\$475 + \$12 (\text{PR} - 70)] \times 0.782$
(e) exceeding 157.5 kW	$[\$1,525 + \$16 (\text{PR} - 157.5)] \times 0.782$
3. Petrol-electric cars	The higher of the appropriate fee payable under item 1 or 2 based on the petrol-electric car's cylinder capacity or power rating
4. Motor cycles and scooters having cylinder capacity —	
(a) not exceeding 200 cubic centimetres	$\$40 \times 0.782$
(b) exceeding 200 cubic centimetres but not exceeding 1,000 cubic centimetres	$[\$40 + \$0.15 (\text{E} - 200)] \times 0.782$
(c) exceeding 1,000 cubic centimetres	$[\$160 + \$0.3 (\text{E} - 1,000)] \times 0.782$
4A. Electric motor cycles and electric scooters, having a power rating not exceeding 10 kW	$\$40 \times 0.782$
5. Taxis	\$510
6. Buses which are diesel-electric vehicles or diesel-	

TWELFTH SCHEDULE — *continued*

Description of vehicle *Fee payable half-yearly*

CNG vehicles or which
use diesel as fuel, and
which are constructed for
the carriage of passengers
not exceeding
30 persons —

Maximum Laden Weight

- | | |
|--|-------|
| (a) not exceeding
3.5 metric tons | \$319 |
| (b) exceeding 3.5 metric
tons but not
exceeding 7.0 metric
tons | \$328 |
| (c) exceeding 7.0 metric
tons but not
exceeding
11.0 metric tons | \$362 |
| (d) exceeding
11.0 metric tons but
not exceeding
16.0 metric tons | \$489 |
| (e) exceeding 16.0
metric tons but not
exceeding
20.0 metric tons
(with 3 axles) | \$553 |
| (f) exceeding 16.0
metric tons but not
exceeding
20.0 metric tons
(with 2 axles) | \$850 |
| (g) exceeding 20.0
metric tons but not
exceeding
26.0 metric tons
(with 3 axles) | \$765 |

TWELFTH SCHEDULE — *continued*

<i>Description of vehicle</i>	<i>Fee payable half-yearly</i>
7. Buses constructed for the carriage of passengers not exceeding 30 persons, using petroleum as fuel —	
<i>Maximum Laden Weight</i>	
(a) not exceeding 3.5 metric tons	\$255
(b) exceeding 3.5 metric tons but not exceeding 7.0 metric tons	\$262
(c) exceeding 7.0 metric tons but not exceeding 11.0 metric tons	\$289
(d) exceeding 11.0 metric tons but not exceeding 16.0 metric tons	\$391
(e) exceeding 16.0 metric tons but not exceeding 20.0 metric tons (with 3 axles)	\$442
(f) exceeding 16.0 metric tons but not exceeding 20.0 metric tons (with 2 axles)	\$680
(g) exceeding 20.0 metric tons but not exceeding 26.0 metric tons (with 3 axles)	\$612
8. Buses which are CNG vehicles, petrol-CNG	

TWELFTH SCHEDULE — *continued*

<i>Description of vehicle</i>	<i>Fee payable half-yearly</i>
vehicles, electric vehicles or petrol-electric vehicles and constructed for the carriage of passengers not exceeding 30 persons —	
<i>Maximum Laden Weight</i>	
(a) not exceeding 3.5 metric tons	\$255
(b) exceeding 3.5 metric tons but not exceeding 7.0 metric tons	\$262
(c) exceeding 7.0 metric tons but not exceeding 11.0 metric tons	\$289
(d) exceeding 11.0 metric tons but not exceeding 16.0 metric tons	\$391
(e) exceeding 16.0 metric tons but not exceeding 20.0 metric tons (with 3 axles)	\$442
(f) exceeding 16.0 metric tons but not exceeding 20.0 metric tons (with 2 axles)	\$680
(g) exceeding 20.0 metric tons but not exceeding 26.0 metric tons (with 3 axles)	\$612

TWELFTH SCHEDULE — *continued*

<i>Description of vehicle</i>	<i>Fee payable half-yearly</i>
9. Buses which are diesel-electric vehicles or diesel-CNG vehicles or which use diesel as fuel, and which are constructed for the carriage of passengers exceeding 30 persons —	
<i>Maximum Laden Weight</i>	
(a) exceeding 3.5 metric tons but not exceeding 7.0 metric tons	\$434
(b) exceeding 7.0 metric tons but not exceeding 11.0 metric tons	\$468
(c) exceeding 11.0 metric tons but not exceeding 16.0 metric tons	\$595
(d) exceeding 16.0 metric tons but not exceeding 20.0 metric tons (with 3 axles)	\$553
(e) exceeding 16.0 metric tons but not exceeding 20.0 metric tons (with 2 axles)	\$850
(f) exceeding 20.0 metric tons but not exceeding 26.0 metric tons (with 3 axles)	\$765
10. Buses constructed for the carriage of passengers	

TWELFTH SCHEDULE — *continued*

<i>Description of vehicle</i>	<i>Fee payable half-yearly</i>
exceeding 30 persons, using petroleum as fuel —	
<i>Maximum Laden Weight</i>	
(a) exceeding 3.5 metric tons but not exceeding 7.0 metric tons	\$347
(b) exceeding 7.0 metric tons but not exceeding 11.0 metric tons	\$374
(c) exceeding 11.0 metric tons but not exceeding 16.0 metric tons	\$476
(d) exceeding 16.0 metric tons but not exceeding 20.0 metric tons (with 3 axles)	\$442
(e) exceeding 16.0 metric tons but not exceeding 20.0 metric tons (with 2 axles)	\$680
(f) exceeding 20.0 metric tons but not exceeding 26.0 metric tons (with 3 axles)	\$612
11. Buses which are CNG vehicles, petrol-CNG vehicles, electric vehicles or petrol-electric vehicles and constructed for the carriage of passengers exceeding 30 persons —	

TWELFTH SCHEDULE — *continued*

<i>Description of vehicle</i>	<i>Fee payable half-yearly</i>
<i>Maximum Laden Weight</i>	
(a) exceeding 3.5 metric tons but not exceeding 7.0 metric tons	\$347
(b) exceeding 7.0 metric tons but not exceeding 11.0 metric tons	\$374
(c) exceeding 11.0 metric tons but not exceeding 16.0 metric tons	\$476
(d) exceeding 16.0 metric tons but not exceeding 20.0 metric tons (with 3 axles)	\$442
(e) exceeding 16.0 metric tons but not exceeding 20.0 metric tons (with 2 axles)	\$680
(f) exceeding 20.0 metric tons but not exceeding 26.0 metric tons (with 3 axles)	\$612

12. Goods vehicles (excluding prime movers and goods-cum-passengers vehicles) which are diesel-electric vehicles or diesel-CNG vehicles or which use diesel as fuel —

Maximum Laden Weight

TWELFTH SCHEDULE — *continued*

<i>Description of vehicle</i>	<i>Fee payable half-yearly</i>
(a) not exceeding 3.5 metric tons	\$213
(b) exceeding 3.5 metric tons but not exceeding 7.0 metric tons	\$328
(c) exceeding 7.0 metric tons but not exceeding 11.0 metric tons	\$362
(d) exceeding 11.0 metric tons but not exceeding 16.0 metric tons	\$489
(e) exceeding 16.0 metric tons but not exceeding 20.0 metric tons (with 2 axles)	\$850
(f) exceeding 16.0 metric tons but not exceeding 20.0 metric tons (with 3 axles)	\$553
(g) exceeding 20.0 metric tons but not exceeding 26.0 metric tons	\$765
(h) exceeding 26.0 metric tons but not exceeding 32.0 metric tons	\$765
(i) exceeding 32.0 metric tons but not exceeding 40.0 metric tons (with 4 axles)	\$1,190

TWELFTH SCHEDULE — *continued*

<i>Description of vehicle</i>	<i>Fee payable half-yearly</i>
(j) exceeding 32.0 metric tons but not exceeding 40.0 metric tons (with 5 or more axles)	\$850
(k) exceeding 40.0 metric tons but not exceeding 55.0 metric tons	\$1,275
(l) exceeding 55.0 metric tons	\$1,488
13. Goods vehicles (excluding prime movers and goods-cum-passengers vehicles) using petroleum as fuel —	
<i>Maximum Laden Weight</i>	
(a) not exceeding 3.5 metric tons	\$170
(b) exceeding 3.5 metric tons but not exceeding 7.0 metric tons	\$262
(c) exceeding 7.0 metric tons but not exceeding 11.0 metric tons	\$289
(d) exceeding 11.0 metric tons but not exceeding 16.0 metric tons	\$391
(e) exceeding 16.0 metric tons but not exceeding	\$680

TWELFTH SCHEDULE — *continued*

<i>Description of vehicle</i>	<i>Fee payable half-yearly</i>
20.0 metric tons (with 2 axles)	
(f) exceeding 16.0 metric tons but not exceeding 20.0 metric tons (with 3 axles)	\$442
(g) exceeding 20.0 metric tons but not exceeding 26.0 metric tons	\$612
(h) exceeding 26.0 metric tons but not exceeding 32.0 metric tons	\$612
(i) exceeding 32.0 metric tons but not exceeding 40.0 metric tons (with 4 axles)	\$952
(j) exceeding 32.0 metric tons but not exceeding 40.0 metric tons (with 5 or more axles)	\$680
(k) exceeding 40.0 metric tons but not exceeding 55.0 metric tons	\$1,020
(l) exceeding 55.0 metric tons	\$1,190
14. Goods vehicles (excluding prime movers and goods-cum-passengers vehicles) which are CNG	

TWELFTH SCHEDULE — *continued*

<i>Description of vehicle</i>	<i>Fee payable half-yearly</i>
vehicles, petrol-CNG vehicles, electric vehicles or petrol-electric vehicles —	
<i>Maximum Laden Weight</i>	
(a) not exceeding 3.5 metric tons	\$170
(b) exceeding 3.5 metric tons but not exceeding 7.0 metric tons	\$262
(c) exceeding 7.0 metric tons but not exceeding 11.0 metric tons	\$289
(d) exceeding 11.0 metric tons but not exceeding 16.0 metric tons	\$391
(e) exceeding 16.0 metric tons but not exceeding 20.0 metric tons (with 2 axles)	\$680
(f) exceeding 16.0 metric tons but not exceeding 20.0 metric tons (with 3 axles)	\$442
(g) exceeding 20.0 metric tons but not exceeding 26.0 metric tons	\$612
(h) exceeding 26.0 metric tons but not	\$612

TWELFTH SCHEDULE — *continued*

<i>Description of vehicle</i>	<i>Fee payable half-yearly</i>
exceeding 32.0 metric tons	
(i) exceeding 32.0 metric tons but not exceeding 40.0 metric tons (with 4 axles)	\$952
(j) exceeding 32.0 metric tons but not exceeding 40.0 metric tons (with 5 or more axles)	\$680
(k) exceeding 40.0 metric tons but not exceeding 55.0 metric tons	\$1,020
(l) exceeding 55.0 metric tons	\$1,190
15. Prime movers which are diesel-electric vehicles or diesel-CNG vehicles or which use diesel as fuel —	
<i>Maximum Laden Weight</i>	
(a) not exceeding 20.0 metric tons	\$553
(b) exceeding 20.0 metric tons but not exceeding 26.0 metric tons	\$765
(c) exceeding 26.0 metric tons but not exceeding 32.0 metric tons	\$765
(d) exceeding 32.0 metric tons but not	\$850

TWELFTH SCHEDULE — *continued*

<i>Description of vehicle</i>	<i>Fee payable half-yearly</i>
exceeding 40.0 metric tons	
(e) exceeding 40.0 metric tons but not exceeding 55.0 metric tons	\$1,275
(f) exceeding 55.0 metric tons	\$1,488
15A. Prime movers using petroleum as fuel —	
<i>Maximum Laden Weight</i>	
(a) not exceeding 20.0 metric tons	\$442
(b) exceeding 20.0 metric tons but not exceeding 26.0 metric tons	\$612
(c) exceeding 26.0 metric tons but not exceeding 32.0 metric tons	\$612
(d) exceeding 32.0 metric tons but not exceeding 40.0 metric tons	\$680
(e) exceeding 40.0 metric tons but not exceeding 55.0 metric tons	\$1,020
(f) exceeding 55.0 metric tons	\$1,190
15B. Prime movers which are CNG vehicles, petrol- CNG vehicles, electric	

TWELFTH SCHEDULE — *continued*

<i>Description of vehicle</i>	<i>Fee payable half-yearly</i>
vehicles or petrol-electric vehicles —	
<i>Maximum Laden Weight</i>	
(a) not exceeding 20.0 metric tons	\$442
(b) exceeding 20.0 metric tons but not exceeding 26.0 metric tons	\$612
(c) exceeding 26.0 metric tons but not exceeding 32.0 metric tons	\$612
(d) exceeding 32.0 metric tons but not exceeding 40.0 metric tons	\$680
(e) exceeding 40.0 metric tons but not exceeding 55.0 metric tons	\$1,020
(f) exceeding 55.0 metric tons	\$1,190
 16. Goods-cum-passengers vehicles which are diesel-electric vehicles or diesel-CNG vehicles or which use diesel as fuel —	
<i>Maximum Laden Weight</i>	
(a) not exceeding 3.5 metric tons	\$372
(b) exceeding 3.5 metric tons	\$487

TWELFTH SCHEDULE — *continued*

<i>Description of vehicle</i>	<i>Fee payable half-yearly</i>
17. Goods-cum-passengers vehicles using petroleum as fuel —	
<i>Maximum Laden Weight</i>	
(a) not exceeding 3.5 metric tons	\$298
(b) exceeding 3.5 metric tons	\$390
18. Goods-cum-passengers vehicles which are CNG vehicles, petrol-CNG vehicles, electric vehicles or petrol-electric vehicles —	
<i>Maximum Laden Weight</i>	
(a) not exceeding 3.5 metric tons	\$298
(b) exceeding 3.5 metric tons	\$390
19. Trailers	\$60

Notes:

1. For the purposes of computing fees payable under this Schedule, any fraction of a dollar shall be reckoned as one dollar.
2. Monthly licence fee payable shall be computed on a pro-rata basis.
3. Annual licence fee payable shall be double the half-yearly licence fee and shall be computed on a pro-rata basis.
4. Motor vehicles equipped with engines using heavy oil, diesel oil, liquefied petroleum gas, natural gas or any other gas as fuel or fitted with producer gas or other gas attachments are chargeable with additional special tax under the Customs Act (Cap. 70).

THIRTEENTH SCHEDULE

Rule 45D(1)

THIRTEENTH SCHEDULE — *continued*

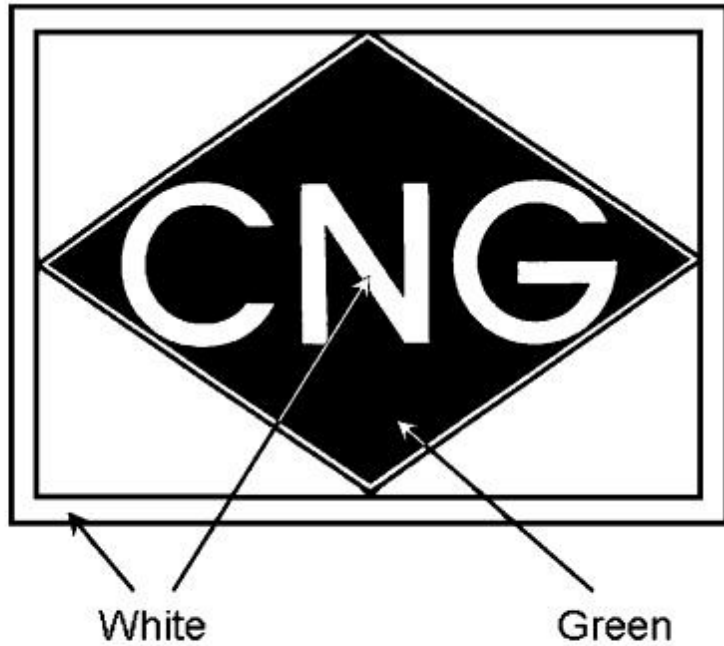

Dimensions

Border Width:	4 — 6 mm
Character Height:	25 mm
Character Thickness:	4 mm
Marking Width:	110 — 150 mm
Marking Height:	80 — 110 mm

Colours

Background:	Green
Border:	White
Letters:	White

FOURTEENTH SCHEDULE

Rules 36(4A) and (4B) and 36C(2)
and (3)

FEEs PAYABLE FOR VEHICLE LICENCES FOR TAXIS, BUSES, GOODS
VEHICLES AND GOODS-CUM-PASSENGERS VEHICLES COMMENCING
ON ANY DATE BETWEEN 1ST JULY 2009 AND 30TH JUNE 2010 (BOTH
DATES INCLUSIVE) OR BETWEEN 1ST JULY 2013 AND 30TH JUNE 2014
(BOTH DATES INCLUSIVE)

<i>Description of vehicle</i>	<i>Fee payable half-yearly</i>
1. Taxis	\$357
2. Buses which are diesel-electric vehicles or diesel-CNG vehicles or which use diesel as fuel, and which are constructed for the carriage of passengers not exceeding 30 persons —	
<i>Maximum Laden Weight</i>	
(a) not exceeding 3.5 metric tons	\$224
(b) exceeding 3.5 metric tons but not exceeding 7.0 metric tons	\$230
(c) exceeding 7.0 metric tons but not exceeding 11.0 metric tons	\$254
(d) exceeding 11.0 metric tons but not exceeding 16.0 metric tons	\$343
(e) exceeding 16.0 metric tons but not exceeding 20.0 metric tons (with 3 axles)	\$388
(f) exceeding 16.0 metric tons but not exceeding 20.0 metric tons (with 2 axles)	\$595
(g) exceeding 20.0 metric tons but not exceeding 26.0 metric tons (with 3 axles)	\$536
3. Buses constructed for the carriage of passengers not exceeding 30 persons, using petroleum as fuel —	

Maximum Laden Weight

FOURTEENTH SCHEDULE — *continued*

<i>Description of vehicle</i>	<i>Fee payable half-yearly</i>
(a) not exceeding 3.5 metric tons	\$179
(b) exceeding 3.5 metric tons but not exceeding 7.0 metric tons	\$184
(c) exceeding 7.0 metric tons but not exceeding 11.0 metric tons	\$203
(d) exceeding 11.0 metric tons but not exceeding 16.0 metric tons	\$274
(e) exceeding 16.0 metric tons but not exceeding 20.0 metric tons (with 3 axles)	\$310
(f) exceeding 16.0 metric tons but not exceeding 20.0 metric tons (with 2 axles)	\$476
(g) exceeding 20.0 metric tons but not exceeding 26.0 metric tons (with 3 axles)	\$429
 4. Buses which are CNG vehicles, petrol-CNG vehicles, electric vehicles or petrol-electric vehicles and constructed for the carriage of passengers not exceeding 30 persons —	
<i>Maximum Laden Weight</i>	
(a) not exceeding 3.5 metric tons	\$179
(b) exceeding 3.5 metric tons but not exceeding 7.0 metric tons	\$184
(c) exceeding 7.0 metric tons but not exceeding 11.0 metric tons	\$203
(d) exceeding 11.0 metric tons but not exceeding 16.0 metric tons	\$274
(e) exceeding 16.0 metric tons but not exceeding 20.0 metric tons (with 3 axles)	\$310

FOURTEENTH SCHEDULE — *continued*

<i>Description of vehicle</i>	<i>Fee payable half-yearly</i>
(f) exceeding 16.0 metric tons but not exceeding 20.0 metric tons (with 2 axles)	\$476
(g) exceeding 20.0 metric tons but not exceeding 26.0 metric tons (with 3 axles)	\$429
5. Buses which are diesel-electric vehicles or diesel-CNG vehicles or which use diesel as fuel, and which are constructed for the carriage of passengers exceeding 30 persons —	
<i>Maximum Laden Weight</i>	
(a) exceeding 3.5 metric tons but not exceeding 7.0 metric tons	\$304
(b) exceeding 7.0 metric tons but not exceeding 11.0 metric tons	\$328
(c) exceeding 11.0 metric tons but not exceeding 16.0 metric tons	\$417
(d) exceeding 16.0 metric tons but not exceeding 20.0 metric tons (with 3 axles)	\$388
(e) exceeding 16.0 metric tons but not exceeding 20.0 metric tons (with 2 axles)	\$595
(f) exceeding 20.0 metric tons but not exceeding 26.0 metric tons (with 3 axles)	\$536
6. Buses constructed for the carriage of passengers exceeding 30 persons, using petroleum as fuel —	
<i>Maximum Laden Weight</i>	
(a) exceeding 3.5 metric tons but not exceeding 7.0 metric tons	\$243

FOURTEENTH SCHEDULE — *continued*

<i>Description of vehicle</i>	<i>Fee payable half-yearly</i>
(b) exceeding 7.0 metric tons but not exceeding 11.0 metric tons	\$262
(c) exceeding 11.0 metric tons but not exceeding 16.0 metric tons	\$334
(d) exceeding 16.0 metric tons but not exceeding 20.0 metric tons (with 3 axles)	\$310
(e) exceeding 16.0 metric tons but not exceeding 20.0 metric tons (with 2 axles)	\$476
(f) exceeding 20.0 metric tons but not exceeding 26.0 metric tons (with 3 axles)	\$429
7. Buses which are CNG vehicles, petrol-CNG vehicles, electric vehicles or petrol-electric vehicles and constructed for the carriage of passengers exceeding 30 persons —	
<i>Maximum Laden Weight</i>	
(a) exceeding 3.5 metric tons but not exceeding 7.0 metric tons	\$243
(b) exceeding 7.0 metric tons but not exceeding 11.0 metric tons	\$262
(c) exceeding 11.0 metric tons but not exceeding 16.0 metric tons	\$334
(d) exceeding 16.0 metric tons but not exceeding 20.0 metric tons (with 3 axles)	\$310
(e) exceeding 16.0 metric tons but not exceeding 20.0 metric tons (with 2 axles)	\$476
(f) exceeding 20.0 metric tons but not exceeding 26.0 metric tons (with 3 axles)	\$429

FOURTEENTH SCHEDULE — *continued*

<i>Description of vehicle</i>	<i>Fee payable half-yearly</i>
8. Goods vehicles (excluding prime movers and goods-cum-passengers vehicles) which are diesel-electric vehicles or diesel-CNG vehicles or which use diesel as fuel —	
<i>Maximum Laden Weight</i>	
(a) not exceeding 3.5 metric tons	\$150
(b) exceeding 3.5 metric tons but not exceeding 7.0 metric tons	\$230
(c) exceeding 7.0 metric tons but not exceeding 11.0 metric tons	\$254
(d) exceeding 11.0 metric tons but not exceeding 16.0 metric tons	\$343
(e) exceeding 16.0 metric tons but not exceeding 20.0 metric tons (with 2 axles)	\$595
(f) exceeding 16.0 metric tons but not exceeding 20.0 metric tons (with 3 axles)	\$388
(g) exceeding 20.0 metric tons but not exceeding 26.0 metric tons	\$536
(h) exceeding 26.0 metric tons but not exceeding 32.0 metric tons	\$536
(i) exceeding 32.0 metric tons but not exceeding 40.0 metric tons (with 4 axles)	\$833
(j) exceeding 32.0 metric tons but not exceeding 40.0 metric tons (with 5 or more axles)	\$595
(k) exceeding 40.0 metric tons but not exceeding 55.0 metric tons	\$893
(l) exceeding 55.0 metric tons	\$1,042

FOURTEENTH SCHEDULE — *continued*

<i>Description of vehicle</i>	<i>Fee payable half-yearly</i>
9. Goods vehicles (excluding prime movers and goods-cum-passengers vehicles) using petroleum as fuel —	
<i>Maximum Laden Weight</i>	
(a) not exceeding 3.5 metric tons	\$119
(b) exceeding 3.5 metric tons but not exceeding 7.0 metric tons	\$184
(c) exceeding 7.0 metric tons but not exceeding 11.0 metric tons	\$203
(d) exceeding 11.0 metric tons but not exceeding 16.0 metric tons	\$274
(e) exceeding 16.0 metric tons but not exceeding 20.0 metric tons (with 2 axles)	\$476
(f) exceeding 16.0 metric tons but not exceeding 20.0 metric tons (with 3 axles)	\$310
(g) exceeding 20.0 metric tons but not exceeding 26.0 metric tons	\$429
(h) exceeding 26.0 metric tons but not exceeding 32.0 metric tons	\$429
(i) exceeding 32.0 metric tons but not exceeding 40.0 metric tons (with 4 axles)	\$667
(j) exceeding 32.0 metric tons but not exceeding 40.0 metric tons (with 5 or more axles)	\$476
(k) exceeding 40.0 metric tons but not exceeding 55.0 metric tons	\$714
(l) exceeding 55.0 metric tons	\$833
10. Goods vehicles (excluding prime movers and goods-cum-passengers vehicles) which are CNG vehicles,	

FOURTEENTH SCHEDULE — *continued*

<i>Description of vehicle</i>	<i>Fee payable half-yearly</i>
petrol-CNG vehicles, electric vehicles or petrol-electric vehicles —	

Maximum Laden Weight

(a) not exceeding 3.5 metric tons	\$119
(b) exceeding 3.5 metric tons but not exceeding 7.0 metric tons	\$184
(c) exceeding 7.0 metric tons but not exceeding 11.0 metric tons	\$203
(d) exceeding 11.0 metric tons but not exceeding 16.0 metric tons	\$274
(e) exceeding 16.0 metric tons but not exceeding 20.0 metric tons (with 2 axles)	\$476
(f) exceeding 16.0 metric tons but not exceeding 20.0 metric tons (with 3 axles)	\$310
(g) exceeding 20.0 metric tons but not exceeding 26.0 metric tons	\$429
(h) exceeding 26.0 metric tons but not exceeding 32.0 metric tons	\$429
(i) exceeding 32.0 metric tons but not exceeding 40.0 metric tons (with 4 axles)	\$667
(j) exceeding 32.0 metric tons but not exceeding 40.0 metric tons (with 5 or more axles)	\$476
(k) exceeding 40.0 metric tons but not exceeding 55.0 metric tons	\$714
(l) exceeding 55.0 metric tons	\$833

11. Prime movers which are diesel-electric
vehicles or diesel-CNG vehicles or
which use diesel as fuel —

Maximum Laden Weight

FOURTEENTH SCHEDULE — *continued*

<i>Description of vehicle</i>	<i>Fee payable half-yearly</i>
(a) not exceeding 20.0 metric tons	\$388
(b) exceeding 20.0 metric tons but not exceeding 26.0 metric tons	\$536
(c) exceeding 26.0 metric tons but not exceeding 32.0 metric tons	\$536
(d) exceeding 32.0 metric tons but not exceeding 40.0 metric tons	\$595
(e) exceeding 40.0 metric tons but not exceeding 55.0 metric tons	\$893
(f) exceeding 55.0 metric tons	\$1,042
12. Prime movers using petroleum as fuel —	
<i>Maximum Laden Weight</i>	
(a) not exceeding 20.0 metric tons	\$310
(b) exceeding 20.0 metric tons but not exceeding 26.0 metric tons	\$429
(c) exceeding 26.0 metric tons but not exceeding 32.0 metric tons	\$429
(d) exceeding 32.0 metric tons but not exceeding 40.0 metric tons	\$476
(e) exceeding 40.0 metric tons but not exceeding 55.0 metric tons	\$714
(f) exceeding 55.0 metric tons	\$833
13. Prime movers which are CNG vehicles, petrol-CNG vehicles, electric vehicles or petrol-electric vehicles —	
<i>Maximum Laden Weight</i>	
(a) not exceeding 20.0 metric tons	\$310
(b) exceeding 20.0 metric tons but not exceeding 26.0 metric tons	\$429
(c) exceeding 26.0 metric tons but not exceeding 32.0 metric tons	\$429

FOURTEENTH SCHEDULE — *continued*

<i>Description of vehicle</i>	<i>Fee payable half-yearly</i>
(d) exceeding 32.0 metric tons but not exceeding 40.0 metric tons	\$476
(e) exceeding 40.0 metric tons but not exceeding 55.0 metric tons	\$714
(f) exceeding 55.0 metric tons	\$833
14. Goods-cum-passengers vehicles which are diesel-electric vehicles or diesel-CNG vehicles or which use diesel as fuel —	
<i>Maximum Laden Weight</i>	
(a) not exceeding 3.5 metric tons	\$261
(b) exceeding 3.5 metric tons	\$341
15. Goods-cum-passengers vehicles using petroleum as fuel —	
<i>Maximum Laden Weight</i>	
(a) not exceeding 3.5 metric tons	\$209
(b) exceeding 3.5 metric tons	\$273
16. Goods-cum-passengers vehicles which are CNG vehicles, petrol-CNG vehicles, electric vehicles or petrol-electric vehicles —	
<i>Maximum Laden Weight</i>	
(a) not exceeding 3.5 metric tons	\$209
(b) exceeding 3.5 metric tons	\$273

Notes:

1. For the purposes of computing fees payable under this Schedule, any fraction of a dollar shall be reckoned as one dollar.
2. Monthly licence fee payable shall be computed on a pro-rata basis.
3. Annual licence fee payable shall be double the half-yearly licence fee and shall be computed on a pro-rata basis.

FOURTEENTH SCHEDULE — *continued*

4. Taxis equipped with engines using heavy oil, diesel oil, liquefied petroleum gas, natural gas or any other gas as fuel or fitted with producer gas or other gas attachments are chargeable with additional special tax under the Customs Act (Cap. 70).

*[G.N. Nos. S 812/2004; S 813/2004; S 226/2005;
S 248/2005; S 398/2005; S 540/2005; S 90/2006;
S 125/2006; S 476/2006; S 505/2006; S 38/2007;
S 116/2007; S 202/2007; S 365/2007; S 467/2007;
S 608/2007; S 610/2007; S 739/2007; S 105/2008;
S 289/2008; S 311/2008; S 429/2008; S 502/2008;
S 519/2008; S 151/2009; S 205/2009; S 225/2009;
S 279/2009; S 318/2009; S 330/2009; S 510/2009;
S 511/2009; S 34/2010; S 356/2010; S 519/2010;
S 336/2011; S 640/2011; S 66/2012; S 144/2012;
S 277/2012; S 311/2012; S 365/2012; S 436/2012;
S 437/2012; S 456/2012; S 651/2012; S 99/2013;
S 131/2013; S 154/2013; S 257/2013; S 304/2013;
S 388/2013; S 554/2013; S 769/2013; S 796/2013;
S 171/2014]*

FIFTEENTH SCHEDULE

Rules 36(4AA), (4C), (4D) and (8),
36B(1A), (1B) and (1C), 36C(2A), (4)
and (5), 36E(2), (3) and (4) and 38B(4)

FEES PAYABLE FOR VEHICLES USING PETROLEUM OR USING
BOTH PETROLEUM AND EITHER NATURAL GAS OR
ELECTRICITY AS THEIR SOURCE OR SOURCES OF POWER, WITH
VEHICLE LICENCES BEGINNING ON ANY DATE DURING THE
PERIOD FROM 1 AUGUST 2015 TO 31 JULY 2016 (BOTH DATES
INCLUSIVE)

<i>Description of vehicle</i>	<i>Fee payable half-yearly</i>
1. Motor cars having cylinder capacity (referred to in this Schedule by the letter “E”) —	
(a) not exceeding 600 cubic centimetres	\$200 × 0.6256
(b) exceeding 600 cubic centimetres but not exceeding 1,000 cubic centimetres	[\$200 + \$0.125 (E-600)] × 0.6256
(c) exceeding 1,000 cubic centimetres but not exceeding 1,600 cubic centimetres	[\$250 + \$0.375(E-1,000)] × 0.6256

FIFTEENTH SCHEDULE — *continued*

<i>Description of vehicle</i>	<i>Fee payable half-yearly</i>
(d) exceeding 1,600 cubic centimetres but not exceeding 3,000 cubic centimetres	$[\$475 + \$0.75(E-1,600)] \times 0.6256$
(e) exceeding 3,000 cubic centimetres	$[\$1,525 + \$1(E-3,000)] \times 0.6256$
2. Petrol-electric cars having a power rating (referred to in this Schedule by the letters “PR”) —	The higher of the appropriate fee payable under item 1 or 2 based on the petrol-electric car’s cylinder capacity or power rating
(a) not exceeding 7.5 kW	$\$200 \times 0.6256$
(b) exceeding 7.5 kW but not exceeding 32.5 kW	$[\$200 + 2(PR-7.5)] \times 0.6256$
(c) exceeding 32.5 kW but not exceeding 70 kW	$[\$250 + 6(PR-32.5)] \times 0.6256$
(d) exceeding 70 kW but not exceeding 157.5 kW	$[\$475 + 12(PR-70)] \times 0.6256$
(e) exceeding 157.5 kW	$[\$1,525 + 16(PR - 157.5)] \times 0.6256$
3. Motor cycles and scooters having cylinder capacity —	
(a) not exceeding 200 cubic centimetres	$\$40 \times 0.3128$
(b) exceeding 200 cubic centimetres but not exceeding 1,000 cubic centimetres	$[\$40 + \$0.15(E - 200)] \times 0.3128$
(c) exceeding 1,000 cubic centimetres	$[\$160 + \$0.3(E - 1,000)] \times 0.3128$
4. Taxis	Nil
5. Buses or buses which are petrol-CNG vehicles or are petrol-electric vehicles, and which are constructed for the carriage of passengers not exceeding 30 persons —	

Maximum Laden Weight

FIFTEENTH SCHEDULE — *continued*

<i>Description of vehicle</i>	<i>Fee payable half-yearly</i>
(a) not exceeding 3.5 metric tons	Nil
(b) exceeding 3.5 metric tons but not exceeding 7.0 metric tons	Nil
(c) exceeding 7.0 metric tons but not exceeding 11.0 metric tons	Nil
(d) exceeding 11.0 metric tons but not exceeding 16.0 metric tons	Nil
(e) exceeding 16.0 metric tons but not exceeding 20.0 metric tons (with 3 axles)	Nil
(f) exceeding 16.0 metric tons but not exceeding 20.0 metric tons (with 2 axles)	Nil
(g) exceeding 20.0 metric tons but not exceeding 26.0 metric tons (with 3 axles)	Nil
6. Buses or buses which are petrol-CNG vehicles or are petrol-electric vehicles, and which are constructed for the carriage of passengers exceeding 30 persons —	
<i>Maximum Laden Weight</i>	
(a) exceeding 3.5 metric tons but not exceeding 7.0 metric tons	Nil
(b) exceeding 7.0 metric tons but not exceeding 11.0 metric tons	Nil
(c) exceeding 11.0 metric tons but not exceeding 16.0 metric tons	Nil

FIFTEENTH SCHEDULE — *continued*

<i>Description of vehicle</i>	<i>Fee payable half-yearly</i>
(d) exceeding 16.0 metric tons but not exceeding 20.0 metric tons (with 3 axles)	Nil
(e) exceeding 16.0 metric tons but not exceeding 20.0 metric tons (with 2 axles)	Nil
(f) exceeding 20.0 metric tons but not exceeding 26.0 metric tons (with 3 axles)	Nil
7. Goods vehicles (excluding prime movers and goods-cum-passengers vehicles), or goods vehicles (excluding prime movers and goods-cum-passengers vehicles) which are petrol-CNG vehicles or are petrol-electric vehicles —	
<i>Maximum Laden Weight</i>	
(a) not exceeding 3.5 metric tons	Nil
(b) exceeding 3.5 metric tons but not exceeding 7.0 metric tons	Nil
(c) exceeding 7.0 metric tons but not exceeding 11.0 metric tons	Nil
(d) exceeding 11.0 metric tons but not exceeding 16.0 metric tons	Nil
(e) exceeding 16.0 metric tons but not exceeding 20.0 metric tons (with 2 axles)	Nil
(f) exceeding 16.0 metric tons but not exceeding 20.0 metric tons (with 3 axles)	Nil
(g) exceeding 20.0 metric tons but not exceeding 26.0 metric tons	Nil

FIFTEENTH SCHEDULE — *continued*

<i>Description of vehicle</i>	<i>Fee payable half-yearly</i>
(h) exceeding 26.0 metric tons but not exceeding 32.0 metric tons	Nil
(i) exceeding 32.0 metric tons but not exceeding 40.0 metric tons (with 4 axles)	Nil
(j) exceeding 32.0 metric tons but not exceeding 40.0 metric tons (with 5 or more axles)	Nil
(k) exceeding 40.0 metric tons but not exceeding 55.0 metric tons	Nil
(l) exceeding 55.0 metric tons	Nil
8. Prime movers or prime movers which are petrol-CNG vehicles or are petrol-electric vehicles —	
<i>Maximum Laden Weight</i>	
(a) not exceeding 20.0 metric tons	Nil
(b) exceeding 20.0 metric tons but not exceeding 26.0 metric tons	Nil
(c) exceeding 26.0 metric tons but not exceeding 32.0 metric tons	Nil
(d) exceeding 32.0 metric tons but not exceeding 40.0 metric tons	Nil
(e) exceeding 40.0 metric tons but not exceeding 55.0 metric tons	Nil
(f) exceeding 55.0 metric tons	Nil
9. Goods-cum-passengers vehicles, or goods-cum-passengers vehicles	

FIFTEENTH SCHEDULE — *continued*

<i>Description of vehicle</i>	<i>Fee payable half-yearly</i>
which are petrol-CNG vehicles or are petrol-electric vehicles —	
<i>Maximum Laden Weight</i>	
(a) not exceeding 3.5 metric tons	Nil
(b) exceeding 3.5 metric tons	Nil

Notes:

1. For the purposes of computing fees payable under this Schedule, any fraction of a dollar is calculated as one dollar.
2. Monthly licence fee payable is computed proportionately.
3. Annual licence fee payable is double the half-yearly licence fee and is computed proportionately.
4. Motor vehicles equipped with engines using heavy oil, diesel oil, liquefied petroleum gas, natural gas or any other gas as fuel or fitted with producer gas or other gas attachments are chargeable with additional special tax under the Customs Act (Cap. 70).

[S 366/2015 wef 14/06/2015]

SIXTEENTH SCHEDULE

Rule 38B(3A), (3B)
and (3C)

FEE PAYABLE FOR PU-REGISTERED VEHICLES USING
PETROLEUM OR USING BOTH PETROLEUM AND EITHER
NATURAL GAS OR ELECTRICITY AS THEIR SOURCE OR
SOURCES OF POWER, WITH VEHICLE LICENCES BEGINNING ON
ANY DATE DURING THE PERIOD FROM 1 AUGUST 2015 TO
31 JULY 2016 (BOTH DATES INCLUSIVE)

<i>Description of vehicle</i>	<i>Fee payable yearly</i>
1. Motor cycles and scooters	\$10
2. Motor cars	\$40
3. Any other vehicle	Nil

[S 366/2015 wef 14/06/2015]

SEVENTEENTH SCHEDULE

Rules 36(4AB), (4E), (4F) and (8),
36C(2B), (6) and (7) and 38B(4)

FEES PAYABLE FOR BUSES, GOODS VEHICLES, PRIME MOVERS
AND GOODS-CUM-PASSENGERS VEHICLES THAT ARE DIESEL
VEHICLES, DIESEL-ELECTRIC VEHICLES OR DIESEL-CNG
VEHICLES, WITH VEHICLE LICENCES BEGINNING ON ANY
DATE DURING THE PERIOD FROM 1 AUGUST 2017 TO
31 JULY 2020 (BOTH DATES INCLUSIVE)

Fee payable half-yearly

<i>Description of vehicle</i>	<i>From 1 August 2017 to 31 July 2018 (both dates inclusive)</i>	<i>From 1 August 2018 to 31 July 2019 (both dates inclusive)</i>	<i>From 1 August 2019 to 31 July 2020 (both dates inclusive)</i>
1. Diesel vehicles, diesel-electric vehicles or diesel-CNG vehicles that are buses constructed for the carriage of passengers not exceeding 30 persons, and with maximum laden weight —			
(a) not exceeding 3.5 metric tons	Nil	\$80	\$240
(b) exceeding 3.5 metric tons but not exceeding 7 metric tons	Nil	\$82	\$246
(c) exceeding 7 metric tons but not exceeding 11 metric tons	Nil	\$91	\$272
(d) exceeding 11 metric tons but not exceeding 16 metric tons	Nil	\$123	\$367
(e) exceeding 16 metric tons but not exceeding 20 metric tons (with 3 axles)	Nil	\$139	\$415
(f) exceeding 16 metric tons but not exceeding 20 metric tons (with 2 axles)	Nil	\$213	\$638
(g) exceeding 20 metric tons but not exceeding 26 metric tons (with 3 axles)	Nil	\$192	\$574

SEVENTEENTH SCHEDULE — *continued*

Fee payable half-yearly

<i>Description of vehicle</i>	<i>From 1 August 2017 to 31 July 2018 (both dates inclusive)</i>	<i>From 1 August 2018 to 31 July 2019 (both dates inclusive)</i>	<i>From 1 August 2019 to 31 July 2020 (both dates inclusive)</i>
2. Diesel vehicles, diesel-electric vehicles or diesel-CNG vehicles that are buses constructed for the carriage of passengers exceeding 30 persons, and with maximum laden weight —			
(a) exceeding 3.5 metric tons but not exceeding 7 metric tons	Nil	\$109	\$326
(b) exceeding 7 metric tons but not exceeding 11 metric tons	Nil	\$117	\$351
(c) exceeding 11 metric tons but not exceeding 16 metric tons	Nil	\$149	\$447
(d) exceeding 16 metric tons but not exceeding 20 metric tons (with 3 axles)	Nil	\$139	\$415
(e) exceeding 16 metric tons but not exceeding 20 metric tons (with 2 axles)	Nil	\$213	\$638
(f) exceeding 20 metric tons but not exceeding 26 metric tons (with 3 axles)	Nil	\$192	\$574
3. Diesel vehicles, diesel-electric vehicles or diesel-CNG vehicles that are goods vehicles (excluding prime movers and goods-cum-passengers vehicles), with maximum laden weight —			
(a) not exceeding 3.5 metric tons	Nil	\$54	\$160
(b) exceeding 3.5 metric tons but not exceeding 7 metric tons	Nil	\$82	\$246

SEVENTEENTH SCHEDULE — *continued*

Fee payable half-yearly

<i>Description of vehicle</i>	<i>From 1 August 2017 to 31 July 2018 (both dates inclusive)</i>	<i>From 1 August 2018 to 31 July 2019 (both dates inclusive)</i>	<i>From 1 August 2019 to 31 July 2020 (both dates inclusive)</i>
(c) exceeding 7 metric tons but not exceeding 11 metric tons	Nil	\$91	\$272
(d) exceeding 11 metric tons but not exceeding 16 metric tons	Nil	\$123	\$367
(e) exceeding 16 metric tons but not exceeding 20 metric tons (with 2 axles)	Nil	\$213	\$638
(f) exceeding 16 metric tons but not exceeding 20 metric tons (with 3 axles)	Nil	\$139	\$415
(g) exceeding 20 metric tons but not exceeding 26 metric tons	Nil	\$192	\$574
(h) exceeding 26 metric tons but not exceeding 32 metric tons	Nil	\$192	\$574
(i) exceeding 32 metric tons but not exceeding 40 metric tons (with 4 axles)	Nil	\$298	\$893
(j) exceeding 32 metric tons but not exceeding 40 metric tons (with 5 or more axles)	Nil	\$213	\$638
(k) exceeding 40 metric tons but not exceeding 55 metric tons	Nil	\$319	\$957
(l) exceeding 55 metric tons	Nil	\$372	\$1,116
4. Diesel vehicles, diesel-electric vehicles or diesel-CNG vehicles that are prime movers, with maximum laden weight —			
(a) not exceeding 20 metric tons	Nil	\$139	\$415
(b) exceeding 20 metric tons but not exceeding 26 metric tons	Nil	\$192	\$574

SEVENTEENTH SCHEDULE — *continued*

Fee payable half-yearly

<i>Description of vehicle</i>	<i>From 1 August 2017 to 31 July 2018 (both dates inclusive)</i>	<i>From 1 August 2018 to 31 July 2019 (both dates inclusive)</i>	<i>From 1 August 2019 to 31 July 2020 (both dates inclusive)</i>
(c) exceeding 26 metric tons but not exceeding 32 metric tons	Nil	\$192	\$574
(d) exceeding 32 metric tons but not exceeding 40 metric tons	Nil	\$213	\$638
(e) exceeding 40 metric tons but not exceeding 55 metric tons	Nil	\$319	\$957
(f) exceeding 55 metric tons	Nil	\$372	\$1,116
5. Diesel vehicles, diesel-electric vehicles or diesel-CNG vehicles that are goods-cum-passengers vehicles, with maximum laden weight —			
(a) not exceeding 3.5 metric tons	Nil	\$93	\$279
(b) exceeding 3.5 metric tons	Nil	\$122	\$366

Notes:

1. For the purposes of computing fees payable under this Schedule, any fraction of a dollar is calculated as one dollar.
2. Monthly licence fee payable is computed proportionately.
3. Annual licence fee payable is double the half-yearly licence fee and is computed proportionately.
4. Where the period for which a licence is taken out falls within more than one of the periods, the fee payable for the licence is computed proportionately.

[S 327/2017 wef 25/06/2017]

EIGHTEENTH SCHEDULE

Rule 38B(3D), (3E) and (3F)

FEES PAYABLE FOR PU-REGISTERED VEHICLES MENTIONED IN
RULE 38B(3D), WITH VEHICLE LICENCES BEGINNING ON ANY
DATE DURING THE PERIOD FROM 1 AUGUST 2017 TO
31 JULY 2020 (BOTH DATES INCLUSIVE)

Fee payable half-yearly

<i>Description of vehicle</i>	<i>From</i>	<i>From</i>	<i>From</i>
	<i>1 August 2017 to 31 July 2018 (both dates inclusive)</i>	<i>1 August 2018 to 31 July 2019 (both dates inclusive)</i>	<i>1 August 2019 to 31 July 2020 (both dates inclusive)</i>
1. PU-registered vehicles mentioned in rule 38B(3D)	Nil	\$13	\$38

Notes:

1. For the purposes of computing fees payable under this Schedule, any fraction of a dollar is calculated as one dollar.
2. Where the period for which a licence is taken out falls within more than one of the periods, the fee payable for the licence is computed proportionately.

[S 327/2017 wef 25/06/2017]

LEGISLATIVE HISTORY
ROAD TRAFFIC (MOTOR VEHICLES, REGISTRATION AND
LICENSING) RULES
(CHAPTER 276, R 5)

This Legislative History is provided for the convenience of users of the Road Traffic (Motor Vehicles, Registration and Licensing) Rules. It is not part of these Rules.

1. G.N. No. S 262/72 — Motor Vehicles (Registration and Licensing) Rules 1972

Date of commencement : 15 September 1972

2. G.N. No. S 295/72 — Motor Vehicles (Registration and Licensing) (Amendment) Rules 1972

Date of commencement : 17 October 1972

3. G.N. No. S 427/73 — Motor Vehicles (Registration and Licensing) (Amendment) Rules 1973

Date of commencement : 1 January 1974

4. G.N. No. S 386/74 — Motor Vehicles (Registration and Licensing) (Amendment) Rules 1974

Date of commencement : 1 January 1975

5. G.N. No. S 24/75 — Motor Vehicles (Registration and Licensing) (Amendment) Rules 1975

Date of commencement : 7 February 1975

6. G.N. No. S 40/75 — Motor Vehicles (Registration and Licensing) (Amendment No. 2) Rules 1975

Date of commencement : 4 March 1975

7. G.N. No. S 184/75 — Motor Vehicles (Registration and Licensing) (Amendment No. 3) Rules 1975

Date of commencement : 1 June 1975

8. G.N. No. S 17/76 — Motor Vehicles (Registration and Licensing) (Amendment) Rules 1976

Date of commencement : 31 December 1975

9. G.N. No. S 86/76 — Motor Vehicles (Registration and Licensing) (Amendment No. 2) Rules 1976

Date of commencement : 1 May 1976

**10. G.N. No. S 70/77 — Motor Vehicles (Registration and Licensing)
(Amendment) Rules 1977**

Date of commencement : 1 April 1977

**11. G.N. No. S 192/77 — Motor Vehicles (Registration and Licensing)
(Amendment No. 2) Rules 1977**

Date of commencement : 1 August 1977

**12. G.N. No. S 229/77 — Motor Vehicles (Registration and Licensing)
(Amendment No. 3) Rules 1977**

Date of commencement : 16 September 1977

**13. G.N. No. S 298/77 — Motor Vehicles (Registration and Licensing)
(Amendment No. 4) Rules 1977**

Date of commencement : 1 December 1977

**14. G.N. No. S 36/78 — Motor Vehicles (Registration and Licensing)
(Amendment) Rules 1978**

Date of commencement : 28 February 1978

**15. G.N. No. S 42/78 — Motor Vehicles (Registration and Licensing)
(Amendment) Rules 1978 (Corrigenda)**

Date of publication : 3 March 1978

**16. G.N. No. S 77/78 — Motor Vehicles (Registration and Licensing)
(Amendment No. 2) Rules 1978**

Date of commencement : 1 April 1978

**17. G.N. No. S 174/78 — Motor Vehicles (Registration and Licensing)
(Amendment No. 3) Rules 1978**

Date of commencement : 1 August 1978

**18. G.N. No. S 215/78 — Motor Vehicles (Registration and Licensing)
(Amendment No. 4) Rules 1978**

Date of commencement : 1 January 1978

**19. G.N. No. S 75/79 — Motor Vehicles (Registration and Licensing)
(Amendment) Rules 1979**

Date of commencement : 2 April 1979

**20. G.N. No. S 268/79 — Motor Vehicles (Registration and Licensing)
(Amendment No. 2) Rules 1979**

Date of commencement : 17 December 1979

- 21. G.N. No. S 36/80 — Motor Vehicles (Registration and Licensing) (Amendment) Rules 1980**
Date of commencement : 6 February 1980
- 22. G.N. No. S 45/80 — Motor Vehicles (Registration and Licensing) (Amendment No. 2) Rules 1980**
Date of commencement : 9 February 1980
- 23. G.N. No. S 51/80 — Motor Vehicles (Registration and Licensing) (Amendment No. 3) Rules 1980**
Date of commencement : 28 February 1980
- 24. G.N. No. S 83/80 — Motor Vehicles (Registration and Licensing) (Amendment No. 4) Rules 1980**
Date of commencement : 17 March 1980
- 25. G.N. No. S 84/80 — Motor Vehicles (Registration and Licensing) (Amendment No. 3) Rules 1980 (Corrigenda)**
Date of publication : 17 March 1980
- 26. G.N. No. S 203/80 — Motor Vehicles (Registration and Licensing) (Amendment No. 5) Rules 1980**
Date of commencement : 1 July 1980
- 27. G.N. No. S 213/80 — Motor Vehicles (Registration and Licensing) (Amendment No. 6) Rules 1980**
Date of commencement : 11 July 1980
- 28. G.N. No. S 221/80 — Motor Vehicles (Registration and Licensing) (Amendment No. 3) Rules 1980 (Corrigenda)**
Date of publication : 18 July 1980
- 29. G.N. No. S 222/80 — Motor Vehicles (Registration and Licensing) (Amendment No. 4) Rules 1980 (Corrigenda)**
Date of publication : 18 July 1980
- 30. G.N. No. S 240/80 — Motor Vehicles (Registration and Licensing) (Amendment No. 7) Rules 1980**
Date of commencement : 1 August 1980
- 31. G.N. No. S 75/81 — Motor Vehicles (Registration and Licensing) (Amendment) Rules 1981**
Date of commencement : 16 March 1981

- 32. G.N. No. S 327/81 — Motor Vehicles (Registration and Licensing) (Amendment No. 2) Rules 1981**
Date of commencement : 1 January 1982
- 33. G.N. No. S 376/81 — Motor Vehicles (Registration and Licensing) (Amendment No. 3) Rules 1981**
Date of commencement : 11 December 1981
- 34. G.N. No. S 78/82 — Motor Vehicles (Registration and Licensing) (Amendment) Rules 1982**
Date of commencement : 1 April 1982
- 35. G.N. No. S 83/82 — Motor Vehicles (Registration and Licensing) (Amendment No. 2) Rules 1982**
Date of commencement : 2 April 1982
- 36. G.N. No. S 17/83 — Motor Vehicles (Registration and Licensing) (Amendment) Rules 1983**
Date of commencement : 21 January 1983
- 37. G.N. No. S 240/83 — Motor Vehicles (Registration and Licensing) (Amendment No. 3) Rules 1983**
Date of commencement : 17 October 1983
- 38. G.N. No. S 313/83 — Motor Vehicles (Registration and Licensing) (Amendment No. 4) Rules 1983**
Date of commencement : 9 December 1983
- 39. G.N. No. S 6/84 — Motor Vehicles (Registration and Licensing) (Amendment) Rules 1984**
Date of commencement : 17 January 1984
- 40. G.N. No. S 107/84 — Motor Vehicles (Registration and Licensing) (Amendment No. 2) Rules 1984**
Date of commencement : 13 April 1984
- 41. G.N. No. S 145/84 — Motor Vehicles (Registration and Licensing) (Amendment No. 3) Rules 1984**
Date of commencement : 1 June 1984
- 42. G.N. No. S 187/84 — Motor Vehicles (Registration and Licensing) (Amendment No. 4) Rules 1984**
Date of commencement : 6 July 1984

**43. G.N. No. S 60/85 — Motor Vehicles (Registration and Licensing)
(Amendment) Rules 1985**

Date of commencement : 9 March 1985

**44. G.N. No. S 37/86 — Motor Vehicles (Registration and Licensing)
(Amendment) Rules 1986**

Date of commencement : 14 February 1986

**45. G.N. No. S 270/87 — Motor Vehicles (Registration and Licensing)
(Amendment) Rules 1987**

Date of commencement : 16 October 1987

**46. G.N. No. S 351/88 — Motor Vehicles (Registration and Licensing)
(Amendment) Rules 1988**

Date of commencement : 9 November 1988

**47. G.N. No. S 256/89 — Motor Vehicles (Registration and Licensing)
(Amendment) Rules 1989**

Date of commencement : 9 June 1989

**48. G.N. No. S 402/89 — Motor Vehicles (Registration and Licensing)
(Amendment No. 2) Rules 1989**

Date of commencement : 6 October 1989

**49. G.N. No. S 424/89 — Motor Vehicles (Registration and Licensing)
(Amendment No. 3) Rules 1989**

Date of commencement : 27 October 1989

**50. G.N. No. S 38/90 — Motor Vehicles (Registration and Licensing)
(Amendment) Rules 1990**

Date of commencement : 26 January 1990

**51. G.N. No. S 42/90 — Motor Vehicles (Registration and Licensing)
(Amendment No. 2) Rules 1990**

Date of commencement : 31 January 1990

**52. G.N. No. S 138/90 — Motor Vehicles (Registration and Licensing)
(Amendment No. 3) Rules 1990**

Date of commencement : 31 March 1990

**53. G.N. No. S 179/90 — Motor Vehicles (Registration and Licensing)
(Amendment No. 4) Rules 1990**

Date of commencement : 1 May 1990

- 54. G.N. No. S 190/90 — Motor Vehicles (Registration and Licensing) (Amendment No. 5) Rules 1990**
Date of commencement : 4 May 1990
- 55. G.N. No. S 224/90 — Motor Vehicles (Registration and Licensing) (Amendment No. 6) Rules 1990**
Date of commencement : 26 May 1990
- 56. G.N. No. S 393/90 — Motor Vehicles (Registration and Licensing) (Amendment No. 7) Rules 1990**
Date of commencement : 1 November 1990
- 57. G.N. No. S 443/90 — Motor Vehicles (Registration and Licensing) (Amendment No. 8) Rules 1990**
Date of commencement : 7 December 1990
- 58. G.N. No. S 457/90 — Motor Vehicles (Registration and Licensing) (Amendment No. 8) Rules 1990 (Corrigenda)**
Date of publication : 14 December 1990
- 59. G.N. No. S 37/91 — Motor Vehicles (Registration and Licensing) (Amendment) Rules 1991**
Date of commencement : 1 February 1991
- 60. G.N. No. S 152/91 — Motor Vehicles (Registration and Licensing) (Amendment No. 2) Rules 1991**
Date of commencement : 1 April 1991
- 61. G.N. No. S 243/91 — Motor Vehicles (Registration and Licensing) (Amendment No. 3) Rules 1991**
Date of commencement : 1 June 1991
- 62. 1990 Revised Edition — Road Traffic (Motor Vehicles, Registration and Licensing) Rules (R 5)**
Date of operation : 25 March 1992
- 63. G.N. No. S 152/92 — Motor Vehicles (Registration and Licensing) (Amendment) Rules 1992**
Date of commencement : 1 April 1992
- 64. G.N. No. S 190/92 — Road Traffic (Motor Vehicles, Registration and Licensing) (Amendment No. 2) Rules 1992**
Date of commencement : 1 May 1992

- 65. G.N. No. S 215/92 — Road Traffic (Motor Vehicles, Registration and Licensing) (Amendment) Rules 1992 (Corrigenda)**
Date of publication : 8 May 1992
- 66. G.N. No. S 379/92 — Road Traffic (Motor Vehicles, Registration and Licensing) (Amendment No. 3) Rules 1992**
Date of commencement : 1 September 1992
- 67. G.N. No. S 452/92 — Road Traffic (Motor Vehicles, Registration and Licensing) (Amendment No. 4) Rules 1992**
Date of commencement : 1 November 1992
- 68. G.N. No. S 346/93 — Road Traffic (Motor Vehicles, Registration and Licensing) (Amendment) Rules 1993**
Date of commencement : 20 August 1993
- 69. G.N. No. S 149/94 — Road Traffic (Motor Vehicles, Registration and Licensing) (Amendment) Rules 1994**
Date of commencement : 1 April 1994
- 70. G.N. No. S 160/94 — Road Traffic (Motor Vehicles, Registration and Licensing) (Amendment No. 2) Rules 1994**
Date of commencement : 1 April 1994
- 71. G.N. No. S 266/94 — Road Traffic (Motor Vehicles, Registration and Licensing) (Amendment No. 3) Rules 1994**
Date of commencement : 1 July 1994
- 72. G.N. No. S 306/94 — Road Traffic (Motor Vehicles, Registration and Licensing) (Amendment No. 4) Rules 1994**
Date of commencement : 29 July 1994
- 73. G.N. No. S 337/94 — Road Traffic (Motor Vehicles, Registration and Licensing) (Amendment No. 5) Rules 1994**
Date of commencement : 1 September 1994
- 74. G.N. No. S 363/94 — Road Traffic (Motor Vehicles, Registration and Licensing) (Amendment No. 6) Rules 1994**
Date of commencement : 1 October 1994
- 75. G.N. No. S 384/94 — Road Traffic (Motor Vehicles, Registration and Licensing) (Amendment No. 7) Rules 1994**
Date of commencement : 1 October 1994

76. G.N. No. S 433/94 — Road Traffic (Motor Vehicles, Registration and Licensing) (Amendment No. 5) Rules 1994 (Corrigendum)

Date of publication : 11 November 1994

77. G.N. No. S 452/94 — Road Traffic (Motor Vehicles, Registration and Licensing) (Amendment No. 8) Rules 1994

Date of commencement : 1 December 1994

78. G.N. No. S 38/95 — Road Traffic (Motor Vehicles, Registration and Licensing) (Amendment) Rules 1995

Date of commencement : 1 February 1995

79. G.N. No. S 64/95 — Road Traffic (Motor Vehicles, Registration and Licensing) (Amendment No. 2) Rules 1995

Date of commencement : 20 February 1995

80. G.N. No. S 83/95 — Road Traffic (Motor Vehicles, Registration and Licensing) (Amendment No. 3) Rules 1995

Date of commencement : 1 March 1995

81. G.N. No. S 300/95 — Road Traffic (Motor Vehicles, Registration and Licensing) (Amendment No. 4) Rules 1995

Date of commencement : 1 July 1995

82. G.N. No. S 299/95 — Road Traffic (Motor Vehicles, Registration and Licensing) (Amendment) Rules 1995 (Corrigenda)

Date of publication : 7 July 1995

83. G.N. No. S 332/95 — Road Traffic (Motor Vehicles, Registration and Licensing) (Amendment No. 5) Rules 1995

Date of commencement : 1 August 1995

84. G.N. No. S 366/95 — Road Traffic (Motor Vehicles, Registration and Licensing) (Amendment No. 6) Rules 1995

Date of commencement : 31 August 1995

85. G.N. No. S 404/95 — Road Traffic (Motor Vehicles, Registration and Licensing) (Amendment No. 7) Rules 1995

Date of commencement : 1 September 1995

86. G.N. No. S 536/95 — Road Traffic (Motor Vehicles, Registration and Licensing) (Amendment No. 8) Rules 1995

Date of commencement : 1 December 1995

87. 1996 Revised Edition — Road Traffic (Motor Vehicles, Registration and Licensing) Rules (R 5)

Date of operation : 15 May 1996

88. G.N. No. S 292/96 — Road Traffic (Motor Vehicles, Registration and Licensing) (Amendment) Rules 1996

Date of commencement : 1 July 1996

89. G.N. No. S 39/97 — Road Traffic (Motor Vehicles, Registration and Licensing) (Amendment) Rules 1997

Date of commencement : 6 February 1997

90. G.N. No. S 358/97 — Road Traffic (Motor Vehicles, Registration and Licensing) (Amendment No. 2) Rules 1997

Date of commencement : 15 August 1997

91. G.N. No. S 125/98 — Road Traffic (Motor Vehicles, Registration and Licensing) (Amendment) Rules 1998

Date of commencement : 23 March 1998

92. G.N. No. S 188/98 — Road Traffic (Motor Vehicles, Registration and Licensing) (Amendment No. 2) Rules 1998

Date of commencement : 1 April 1998

93. G.N. No. S 388/98 — Road Traffic (Motor Vehicles, Registration and Licensing) (Amendment No. 3) Rules 1998

Date of commencement : 17 July 1998

94. G.N. No. S 517/98 — Road Traffic (Motor Vehicles, Registration and Licensing) (Amendment No. 4) Rules 1998

Date of commencement : 12 October 1998

95. G.N. No. S 537/98 — Road Traffic (Motor Vehicles, Registration and Licensing) (Amendment No. 5) Rules 1998

Date of commencement : 1 November 1998

96. G.N. No. S 42/99 — Road Traffic (Motor Vehicles, Registration and Licensing) (Amendment) Rules 1999

Date of commencement : 1 February 1999

97. G.N. No. S 173/99 — Road Traffic (Motor Vehicles, Registration and Licensing) (Amendment No. 2) Rules 1999

Date of commencement : 1 April 1999

98. 1999 Revised Edition — Road Traffic (Motor Vehicles, Registration and Licensing) Rules (R 5)

Date of operation : 30 September 1999

99. G.N. No. S 535/99 — Road Traffic (Motor Vehicles, Registration and Licensing) (Amendment No. 3) Rules 1999

Date of commencement : 2 December 1999

100. G.N. No. S 226/2000 — Road Traffic (Motor Vehicles, Registration and Licensing) (Amendment) Rules 2000

Date of commencement : 2 May 2000

101. G.N. No. S 246/2000 — Road Traffic (Motor Vehicles, Registration and Licensing) (Amendment No. 2) Rules 2000

Date of commencement : 1 June 2000

102. G.N. No. S 261/2000 — Road Traffic (Motor Vehicles, Registration and Licensing) (Amendment No. 3) Rules 2000

Date of commencement : 5 June 2000

103. G.N. No. S 310/2000 — Road Traffic (Motor Vehicles, Registration and Licensing) (Amendment No. 4) Rules 2000

Date of commencement : 1 July 2000

104. G.N. No. S 320/2000 — Road Traffic (Motor Vehicles, Registration and Licensing) (Amendment No. 5) Rules 2000

Date of commencement : 11 July 2000

105. G.N. No. S 430/2000 — Road Traffic (Motor Vehicles, Registration and Licensing) (Amendment No. 6) Rules 2000

Date of commencement : 2 October 2000

106. G.N. No. S 460/2000 — Road Traffic (Motor Vehicles, Registration and Licensing) (Amendment No. 7) Rules 2000

Date of commencement : 9 October 2000

107. G. N. No. S 600/2000 — Road Traffic (Motor Vehicles, Registration and Licensing) (Amendment No. 8) Rules 2000

Date of commencement : 2 January 2001

108. G. N. No. S 6/2001 — Road Traffic (Motor Vehicles, Registration and Licensing) (Amendment) Rules 2001

Date of commencement : 3 January 2001

- 109. G.N. No. S 336/2001 — Road Traffic (Motor Vehicles, Registration and Licensing) (Amendment No. 2) Rules 2001**
Date of commencement : 2 July 2001
- 110. G.N. No. S 432/2001 — Road Traffic (Motor Vehicles, Registration and Licensing) (Amendment No. 3) Rules 2001**
Date of commencement : 10 September 2001
- 111. G.N. No. S 605/2001 — Road Traffic (Motor Vehicles, Registration and Licensing) (Amendment No. 4) Rules 2001**
Date of commencement : 3 December 2001
- 112. G.N. No. S 686/2001 — Road Traffic (Motor Vehicles, Registration and Licensing) (Amendment No. 5) Rules 2001**
Date of commencement : 1 January 2002
- 113. G.N. No. S 425/2002 — Road Traffic (Motor Vehicles, Registration and Licensing) (Amendment No. 4) Rules 2002**
Date of commencement : 4 May 2002
- 114. G.N. No. S 204/2002 — Road Traffic (Motor Vehicles, Registration and Licensing) (Amendment) Rules 2002**
Date of commencement : 4 May 2002
- 115. G.N. No. S 90/2003 — Road Traffic (Motor Vehicles, Registration and Licensing) (Amendment No. 4) Rules 2003**
Date of commencement : 4 May 2002
- 116. G.N. No. S 253/2002 — Road Traffic (Motor Vehicles, Registration and Licensing) (Amendment No. 2) Rules 2002**
Date of commencement : 28 May 2002
- 117. G.N. No. S 321/2002 — Road Traffic (Motor Vehicles, Registration and Licensing) (Amendment No. 3) Rules 2002**
Date of commencement : 1 July 2002
- 118. G.N. No. S 425/2002 — Road Traffic (Motor Vehicles, Registration and Licensing) (Amendment No. 4) Rules 2002**
Date of commencement : 26 August 2002
- 119. G.N. No. S 11/2003 — Road Traffic (Motor Vehicles, Registration and Licensing) (Amendment) Rules 2003**
Date of commencement : 3 January 2003

- 120. G.N. No. S 72/2003 — Road Traffic (Motor Vehicles, Registration and Licensing) (Amendment No. 2) Rules 2003**
Date of commencement : 14 February 2003
- 121. G.N. No. S 86/2003 — Road Traffic (Motor Vehicles, Registration and Licensing) (Amendment No. 3) Rules 2003**
Date of commencement : 24 February 2003
- 122. G.N. No. S 90/2003 — Road Traffic (Motor Vehicles, Registration and Licensing) (Amendment No. 4) Rules 2003**
Date of commencement : 25 February 2003
- 123. G.N. No. S 382/2003 — Road Traffic (Motor Vehicles, Registration and Licensing) (Amendment No. 5) Rules 2003**
Date of commencement : 7 August 2003
- 124. G.N. No. S 427/2003 — Road Traffic (Motor Vehicles, Registration and Licensing) (Amendment No. 6) Rules 2003**
Date of commencement : 1 September 2003
- 125. G.N. No. S 526/2003 — Road Traffic (Motor Vehicles, Registration and Licensing) (Amendment No. 7) Rules 2003**
Date of commencement : 17 November 2003
- 126. G.N. No. S 609/2003 — Road Traffic (Motor Vehicles, Registration and Licensing) (Amendment No. 8) Rules 2003**
Date of commencement : 22 December 2003
- 127. G.N. No. S 635/2003 — Road Traffic (Motor Vehicles, Registration and Licensing) (Amendment No. 9) Rules 2003**
Date of commencement : 1 January 2004
- 128. G.N. No. S 83/2004 — Road Traffic (Motor Vehicles, Registration and Licensing) (Amendment) Rules 2004**
Date of commencement : 28 February 2004
- 129. G.N. No. S 95/2004 — Road Traffic (Motor Vehicles, Registration and Licensing) (Amendment No. 2) Rules 2004**
Date of commencement : 3 March 2004
- 130. G.N. No. S 313/2004 — Road Traffic (Motor Vehicles, Registration and Licensing) (Amendment No. 3) Rules 2004**
Date of commencement : 1 June 2004

- 131. G.N. No. S 465/2004 — Road Traffic (Motor Vehicles, Registration and Licensing) (Amendment No. 4) Rules 2004**
Date of commencement : 2 August 2004
- 132. G.N. No. S 579/2004 — Road Traffic (Motor Vehicles, Registration and Licensing) (Amendment No. 5) Rules 2004**
Date of commencement : 15 September 2004
- 133. G.N. No. S 812/2004 — Road Traffic (Motor Vehicles, Registration and Licensing) (Amendment No. 6) Rules 2004**
Date of commencement : 31 December 2004
- 134. 2004 Revised Edition — Road Traffic (Motor Vehicles, Registration and Licensing) Rules (R 5)**
Date of operation : 31 December 2004
- 135. G.N. No. S 813/2004 — Road Traffic (Motor Vehicles, Registration and Licensing) (Amendment No. 7) Rules 2004**
Date of commencement : 1 January 2005
- 136. G.N. No. S 226/2005 — Road Traffic (Motor Vehicles, Registration and Licensing) (Amendment) Rules 2005**
Date of commencement : 5 April 2005
- 137. G.N. No. S 248/2005 — Road Traffic (Motor Vehicles, Registration and Licensing) (Amendment No. 2) Rules 2005**
Date of commencement : 12 April 2005
- 138. G.N. No. S 505/2006 — Road Traffic (Motor Vehicles, Registration and Licensing) (Amendment No. 4) Rules 2006**
Date of commencement : 1 May 2005
- 139. G.N. No. S 398/2005 — Road Traffic (Motor Vehicles, Registration and Licensing) (Amendment No. 3) Rules 2005**
Date of commencement : 20 June 2005
- 140. G.N. No. S 540/2005 — Road Traffic (Motor Vehicles, Registration and Licensing) (Amendment No. 4) Rules 2005**
Date of commencement : 15 August 2005
- 141. G. N. No. S 90/2006 — Road Traffic (Motor Vehicles, Registration and Licensing) (Amendment) Rules 2006**
Date of commencement : 1 January 2006

- 142. G.N. No. S 125/2006 — Road Traffic (Motor Vehicles, Registration and Licensing) (Amendment No. 2) Rules 2006**
Date of commencement : 27 February 2006
- 143. G.N. No. S 476/2006 — Road Traffic (Motor Vehicles, Registration and Licensing) (Amendment No. 3) Rules 2006**
Date of commencement : 1 August 2006
- 144. G.N. No. S 38/2007 — Road Traffic (Motor Vehicles, Registration and Licensing) (Amendment) Rules 2007**
Date of commencement : 26 January 2007
- 145. G.N. No. S 116/2007 — Road Traffic (Motor Vehicles, Registration and Licensing) (Amendment No. 2) Rules 2007**
Date of commencement : 19 March 2007
- 146. G.N. No. S 202/2007 — Road Traffic (Motor Vehicles, Registration and Licensing) (Amendment No. 3) Rules 2007**
Date of commencement : 11 May 2007
- 147. G.N. No. S 365/2007 — Road Traffic (Motor Vehicles, Registration and Licensing) (Amendment No. 4) Rules 2007**
Date of commencement : 1 September 2007
- 148. G.N. No. S 467/2007 — Road Traffic (Motor Vehicles, Registration and Licensing) (Amendment No. 5) Rules 2007**
Date of commencement : 1 September 2007
- 149. G.N. No. S 608/2007 — Road Traffic (Motor Vehicles, Registration and Licensing) (Amendment No. 6) Rules 2007**
Date of commencement : 6 November 2007
- 150. G.N. No. S 610/2007 — Road Traffic (Motor Vehicles, Registration and Licensing) (Amendment No. 7) Rules 2007**
Date of commencement : 1 December 2007
- 151. G.N. No. S 739/2007 — Road Traffic (Motor Vehicles, Registration and Licensing) (Amendment No. 8) Rules 2007**
Date of commencement : 1 January 2008
- 152. G.N. No. S 105/2008 — Road Traffic (Motor Vehicles, Registration and Licensing) (Amendment) Rules 2008**
Date of commencement : 1 March 2008

- 153. G.N. No. S 311/2008 — Road Traffic (Motor Vehicles, Registration and Licensing) (Amendment No. 3) Rules 2008**
Date of commencement : 18 June 2008
- 154. G.N. No. S 289/2008 — Road Traffic (Motor Vehicles, Registration and Licensing) (Amendment No. 2) Rules 2008**
Date of commencement : 1 July 2008
- 155. G.N. No. S 429/2008 — Road Traffic (Motor Vehicles, Registration and Licensing) (Amendment No. 4) Rules 2008**
Date of commencement : 1 September 2008
- 156. G.N. No. S 318/2009 — Road Traffic (Motor Vehicles, Registration and Licensing) (Amendment No. 5) Rules 2009**
Date of commencement : 1 September 2008
- 157. G.N. No. S 502/2008 — Road Traffic (Motor Vehicles, Registration and Licensing) (Amendment No. 5) Rules 2008**
Date of commencement : 13 October 2008
- 158. G. N. No. S 519/2008 — Road Traffic (Motor Vehicles, Registration and Licensing) (Amendment No. 6) Rules 2008**
Date of commencement : 20 October 2008
- 159. G.N. No. S 151/2009 — Road Traffic (Motor Vehicles, Registration and Licensing) (Amendment) Rules 2009**
Date of commencement : 13 April 2009
- 160. G. N. No. S 205/2009 — Road Traffic (Motor Vehicles, Registration and Licensing) (Amendment No. 2) Rules 2009**
Date of commencement : 9 May 2009
- 161. G.N. No. S 225/2009 — Road Traffic (Motor Vehicles, Registration and Licensing) (Amendment No. 3) Rules 2009**
Date of commencement : 25 May 2009
- 162. G.N. No. S 279/2009 — Road Traffic (Motor Vehicles, Registration and Licensing) (Amendment No. 4) Rules 2009**
Date of commencement : 22 June 2009
- 163. G.N. No. S 330/2009 — Road Traffic (Motor Vehicles, Registration and Licensing) (Amendment No. 6) Rules 2009**
Date of commencement : 17 July 2009

- 164. G.N. No. S 510/2009 — Road Traffic (Motor Vehicles, Registration and Licensing) (Amendment No. 7) Rules 2009**
Date of commencement : 26 October 2009
- 165. G.N. No. S 511/2009 — Road Traffic (Motor Vehicles, Registration and Licensing) (Amendment No. 8) Rules 2009**
Date of commencement : 23 November 2009
- 166. G.N. No. S 34/2010 — Road Traffic (Motor Vehicles, Registration and Licensing) (Amendment) Rules 2010**
Date of commencement : 25 January 2010
- 167. G.N. No. S 356/2010 — Road Traffic (Motor Vehicles, Registration and Licensing) (Amendment No. 2) Rules 2010**
Date of commencement : 1 July 2010
- 168. G.N. No. S 519/2010 — Road Traffic (Motor Vehicles, Registration and Licensing) (Amendment No. 3) Rules 2010**
Date of commencement : 16 September 2010
- 169. G.N. No. S 336/2011 — Road Traffic (Motor Vehicles, Registration and Licensing) (Amendment) Rules 2011**
Date of commencement : 22 June 2011
- 170. G.N. No. S 640/2011 — Road Traffic (Motor Vehicles, Registration and Licensing) (Amendment No. 2) Rules 2011**
Date of commencement : 1 December 2011
- 171. G.N. No. S 66/2012 — Road Traffic (Motor Vehicles, Registration and Licensing) (Amendment) Rules 2012**
Date of commencement : 18 February 2012
- 172. G.N. No. S 144/2012 — Road Traffic (Motor Vehicles, Registration and Licensing) (Amendment No. 2) Rules 2012**
Date of commencement : 9 April 2012
- 173. G.N. No. S 277/2012 — Road Traffic (Motor Vehicles, Registration and Licensing) (Amendment No. 3) Rules 2012**
Date of commencement : 11 June 2012
- 174. G.N. No. S 311/2012 — Road Traffic (Motor Vehicles, Registration and Licensing) (Amendment No. 4) Rules 2012**
Date of commencement : 1 July 2012

- 175. G.N. No. S 365/2012 — Road Traffic (Motor Vehicles, Registration and Licensing) (Amendment No. 5) Rules 2012**
Date of commencement : 1 August 2012
- 176. G.N. No. S 436/2012 — Road Traffic (Motor Vehicles, Registration and Licensing) (Amendment No. 6) Rules 2012**
Date of commencement : 1 September 2012
- 177. G.N. No. S 437/2012 — Road Traffic (Motor Vehicles, Registration and Licensing) (Amendment No. 7) Rules 2012**
Date of commencement : 1 September 2012
- 178. G.N. No. S 456/2012 — Road Traffic (Motor Vehicles, Registration and Licensing) (Amendment No. 8) Rules 2012**
Date of commencement : 17 September 2012
- 179. G.N. No. S 651/2012 — Road Traffic (Motor Vehicles, Registration and Licensing) (Amendment No. 9) Rules 2012**
Date of commencement : 1 January 2013
- 180. G.N. No. S 99/2013 — Road Traffic (Motor Vehicles, Registration and Licensing) (Amendment) Rules 2013**
Date of commencement : 26 February 2013
- 181. G.N. No. S 154/2013 — Road Traffic (Motor Vehicles, Registration and Licensing) (Amendment No. 3) Rules 2013**
Date of commencement : 7 March 2013
- 182. G.N. No. S 131/2013 — Road Traffic (Motor Vehicles, Registration and Licensing) (Amendment No. 2) Rules 2013**
Date of commencement : 8 March 2013
- 183. G.N. No. S 257/2013 — Road Traffic (Motor Vehicles, Registration and Licensing) (Amendment No. 4) Rules 2013**
Date of commencement : 24 April 2013
- 184. G.N. No. S 304/2013 — Road Traffic (Motor Vehicles, Registration and Licensing) (Amendment No. 5) Rules 2013**
Date of commencement : 19 May 2013
- 185. G.N. No. S 388/2013 — Road Traffic (Motor Vehicles, Registration and Licensing) (Amendment No. 6) Rules 2013**
Date of commencement : 1 July 2013

186. G.N. No. S 554/2013 — Road Traffic (Motor Vehicles, Registration and Licensing) (Amendment No. 7) Rules 2013

Date of commencement : 1 September 2013

187. G.N. No. S 769/2013 — Road Traffic (Motor Vehicles, Registration and Licensing) (Amendment No. 8) Rules 2013

Date of commencement : 20 December 2013

188. G.N. No. S 796/2013 — Road Traffic (Motor Vehicles, Registration and Licensing) (Amendment No. 9) Rules 2013

Date of commencement : 1 January 2014

189. G.N. No. S 171/2014 — Road Traffic (Motor Vehicles, Registration and Licensing) (Amendment) Rules 2014

Date of commencement : 12 March 2014

190. 2014 Revised Edition — Road Traffic (Motor Vehicles, Registration and Licensing) Rules (R 5)

Date of operation : 22 August 2014

191. G.N. No. S 678/2014 — Road Traffic (Motor Vehicles, Registration and Licensing) (Amendment No. 2) Rules 2014

Date of commencement : 3 October 2014

192. G.N. No. S 810/2014 — Road Traffic (Motor Vehicles, Registration and Licensing) (Amendment No. 3) Rules 2014

Date of commencement : 12 December 2014

193. G. N. No. S 366/2015 — Road Traffic (Motor Vehicles, Registration and Licensing) (Amendment No. 2) Rules 2015
(G.N. No. S 231/2016 — Corrigendum)

Date of commencement : 14 June 2015

194. G.N. No. S 359/2015 — Road Traffic (Motor Vehicles, Registration and Licensing) (Amendment) Rules 2015

Date of commencement : 1 July 2015

195. G.N. No. S 650/2015 — Road Traffic (Motor Vehicles, Registration and Licensing) (Amendment No. 3) Rules 2015

Date of commencement : 6 November 2015

196. G.N. No. S 272/2016 — Road Traffic (Motor Vehicles, Registration and Licensing) (Amendment) Rules 2016

Date of commencement : 17 June 2016

197. G.N. No. S 46/2017 — Road Traffic (Motor Vehicles, Registration and Licensing) (Amendment) Rules 2017

Date of commencement : 15 February 2017

198. G.N. No. S 60/2017 — Road Traffic (Motor Vehicles, Registration and Licensing) (Amendment No. 2) Rules 2017

Date of commencement : 21 February 2017

199. G.N. No. S 327/2017 — Road Traffic (Motor Vehicles, Registration and Licensing) (Amendment No. 3) Rules 2017

Date of commencement : 25 June 2017

200. G.N. No. S 335/2017 — Road Traffic (Motor Vehicles, Registration and Licensing) (Amendment No. 4) Rules 2017

Date of commencement : 30 June 2017

201. G.N. No. S 550/2017 — Road Traffic (Motor Vehicles, Registration and Licensing) (Amendment No. 5) Rules 2017

Date of commencement : 1 October 2017

202. G.N. No. S 696/2017 — Road Traffic (Motor Vehicles, Registration and Licensing) (Amendment No. 6) Rules 2017

Date of commencement : 20 December 2017

203. G.N. No. S 777/2017 — Road Traffic (Motor Vehicles, Registration and Licensing) (Amendment No. 7) Rules 2017

(G.N. No. S 38/2018 — Corrigenda)

Date of commencement : 1 January 2018

204. G.N. No. S 263/2021 — Road Traffic (Motor Vehicles, Registration and Licensing) (Amendment No. 2) Rules 2021

Dates of commencement : 1 January 2013
1 January 2018